

	1	2	3	4	5	6
A						
B						
C						
D						
	1	2	3	4	5	6

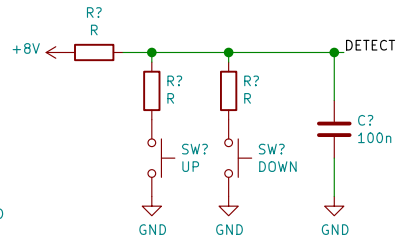

Sheet: /		
File: MicAndFrontend.sch		
<b>Title:</b>		
Size: A4	Date:	<b>Rev:</b>
KiCad E.D.A. eeschema (5.0.0-rc3-dev-2-g101b68b61)		Id: 1/2

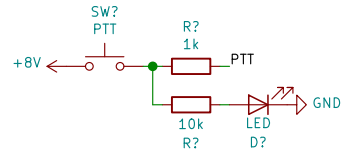
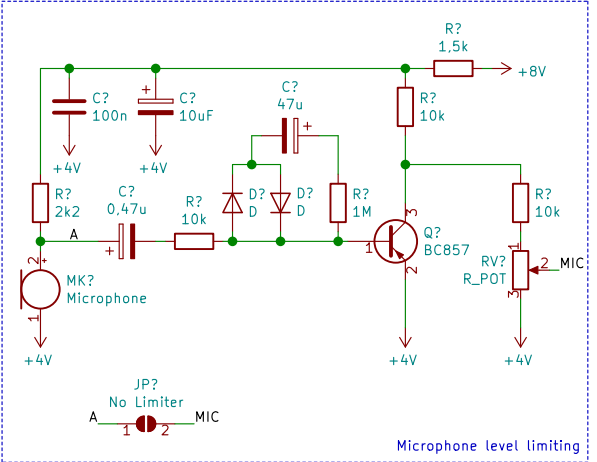
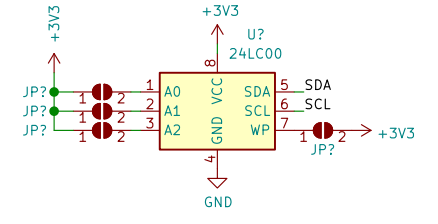
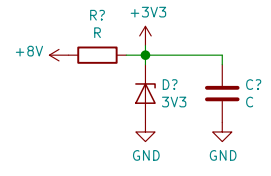
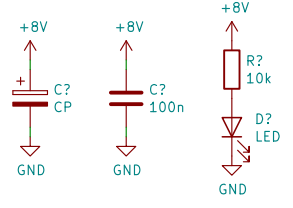
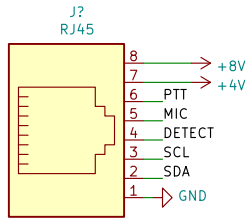

Sheet: /Microphone/	
File: Microphone.sch	
<b>Title:</b>	
Size: A4	Date:
KiCad E.D.A. eeschema (5.0.0-rc3-dev-2-g101b68b61)	
Rev: Id: 2/2	