

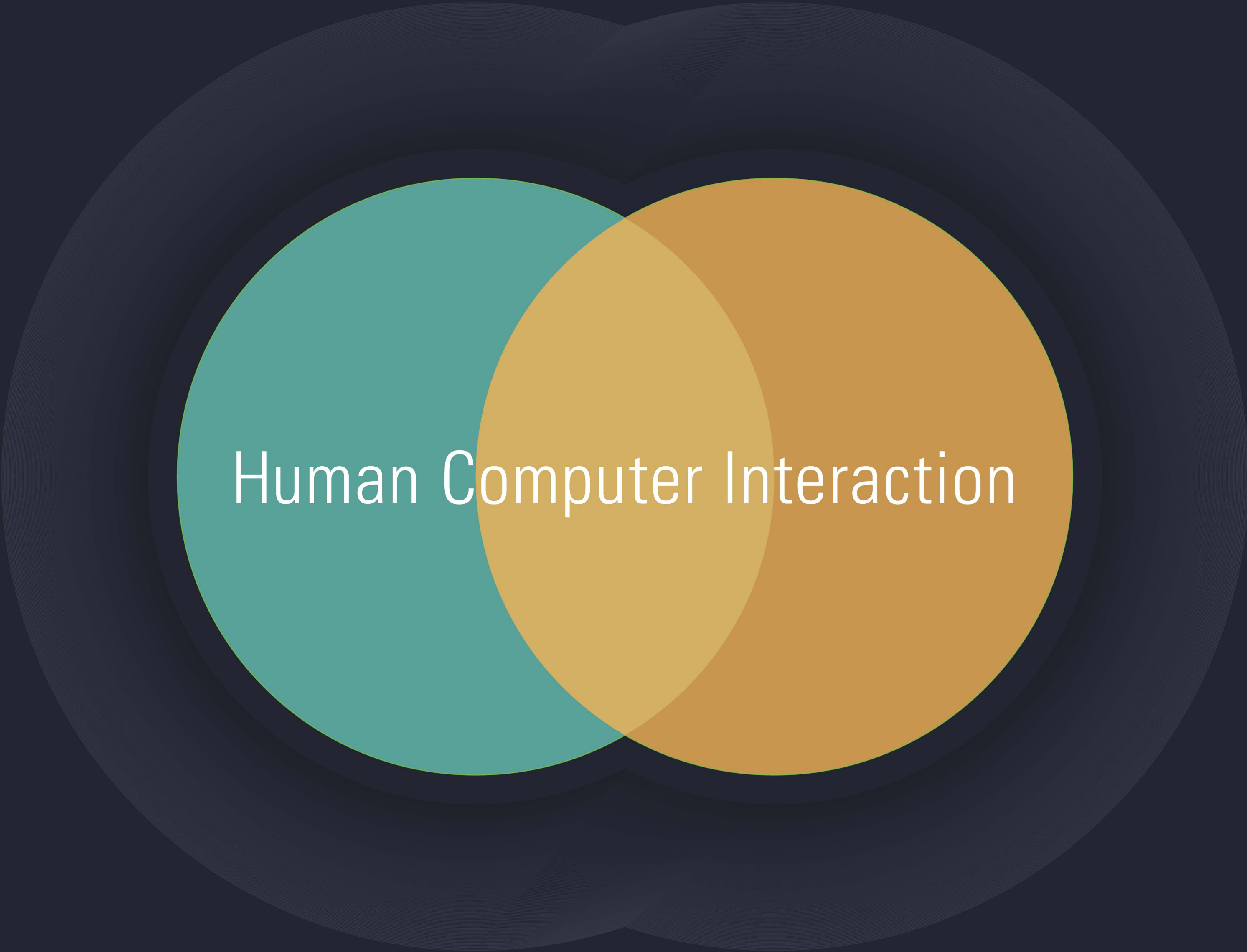

Human-Data Interfaces

A CASE FOR
HARDWARE-DRIVEN
INNOVATION

Aleksandar Bradic
Sketching in Hardware '19



Human Computer Interaction

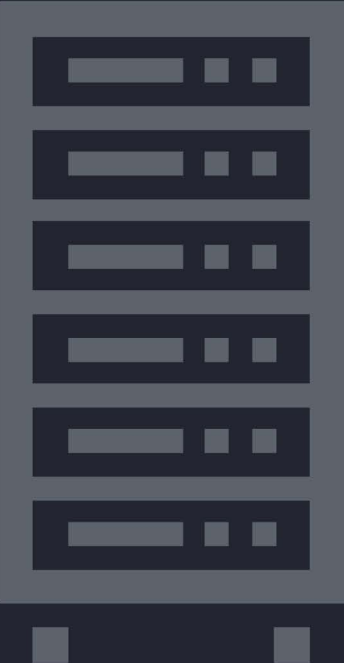

0.1 second *is the response time limit if you want users to feel like their actions are directly causing something to happen on the screen.*

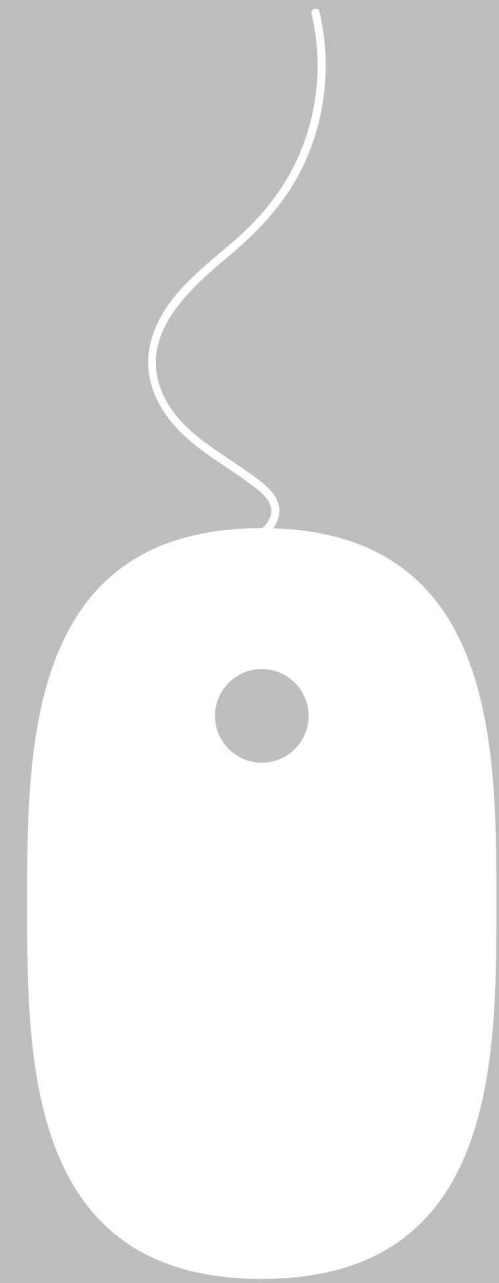
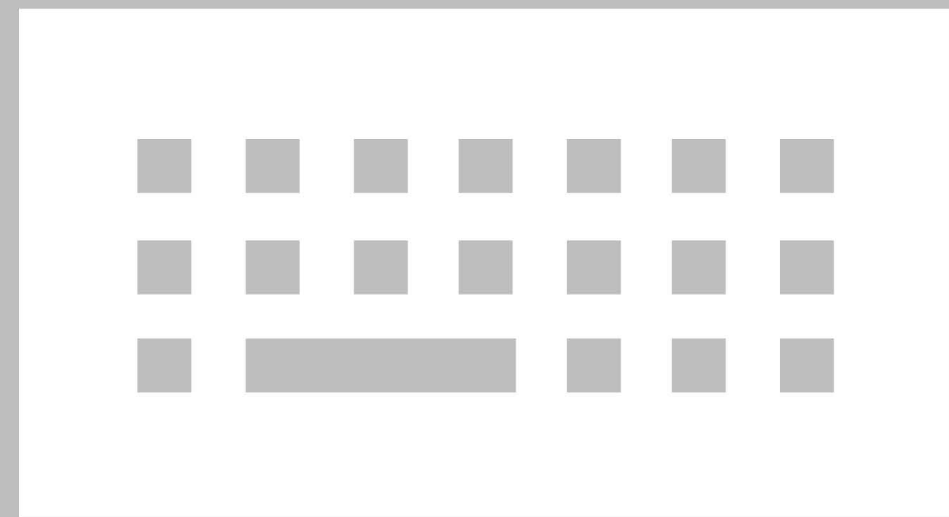

When the computer takes **more than 0.1 second but less than 1 second** *to respond to your input, it feels like the computer is causing the result to appear.*

Keystroke two-at-a-time

Historical legacy
of the “two-key rollover”

PS/2 provides no
rollover restrictions

USB boot keyboard
reintroduces 6-key rollover



Point & click

2D Continuous
Spatial Data Optimized

Alternating
control with a keyboard

Pointing to one screen
location at the time

Single-Threaded Control

HUMAN

15ms

Average Touch Stimulus
Reaction Time

17ms

Average Audio Stimulus
Reaction Time

25ms

Average Visual Stimulus
Reaction Time

CLOUD

50ms

Cloud Round Trip Latency
(USA)

250ms

Cloud Round Trip Latency
(Australia)

8.66sec

Average Web page
full page load



Human Computer Cloud
Interaction → Transaction



The Unknowable

Interactive

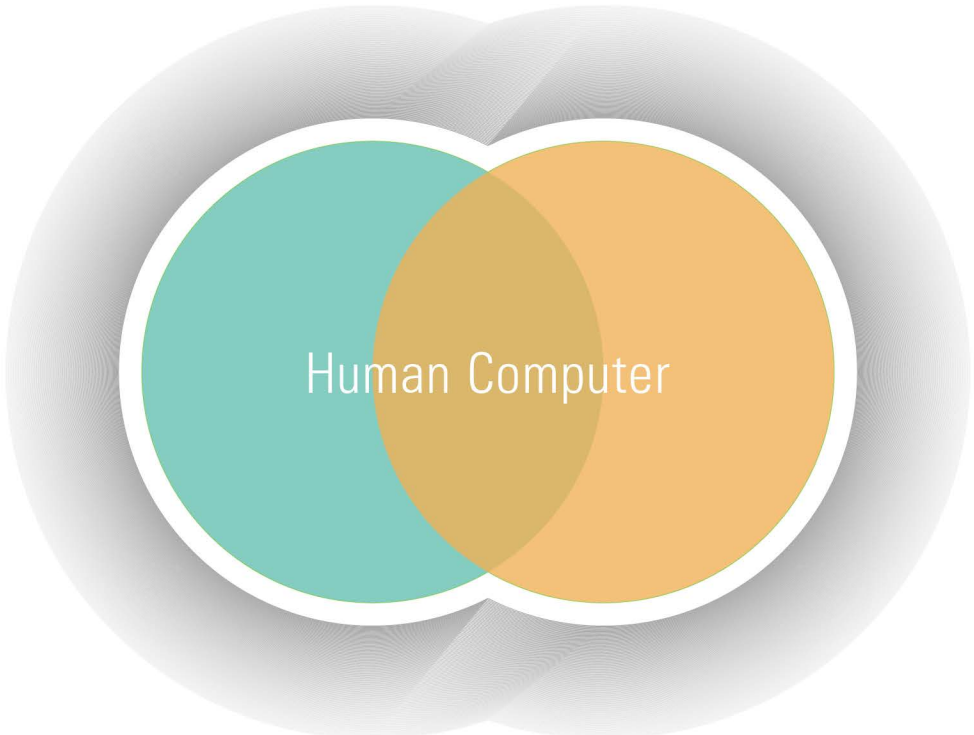

Human-data Interaction (HDI)

It arises from the need, both ethical and practical, to engage users to a much greater degree with the collection, analysis, and trade of their personal data, in addition to providing them with an intuitive feedback mechanism direct data access.

*Human-data Interaction, Hamed Haddadi, Richard Mortier, Derek McAuley, Jon Crowcroft
Technical Report, University of Cambridge, June 2013*

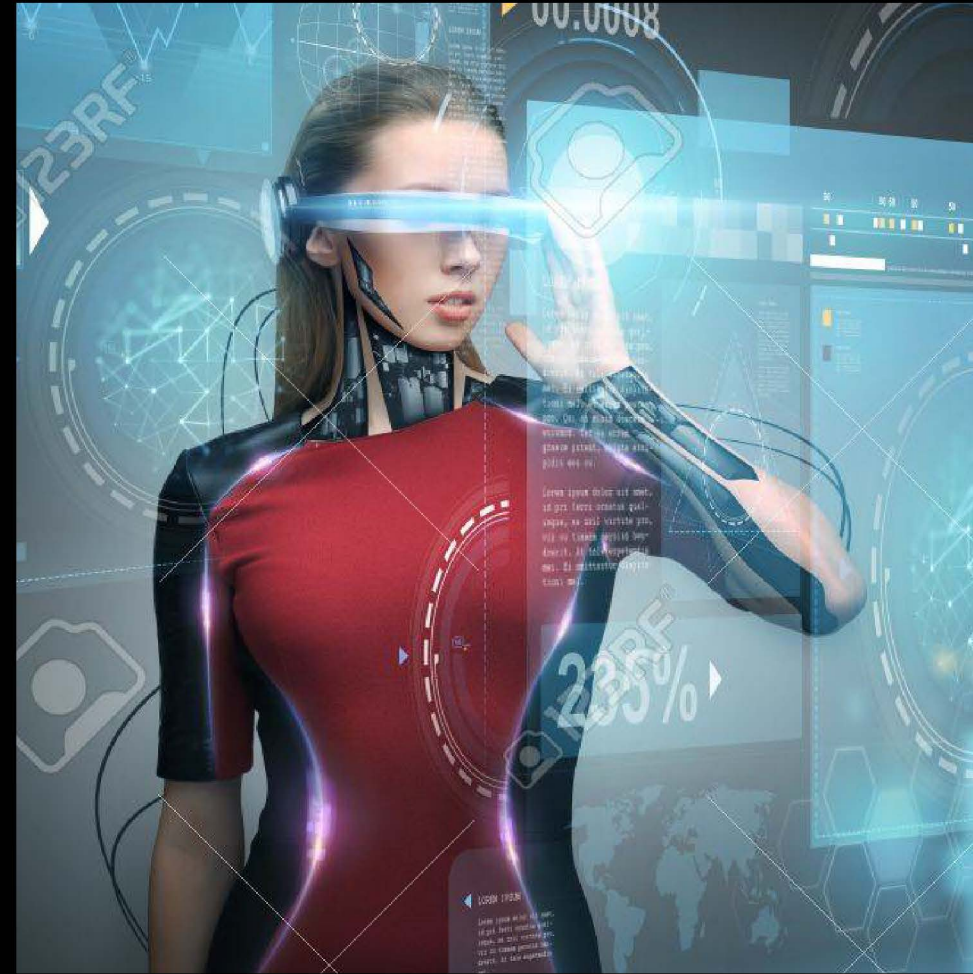
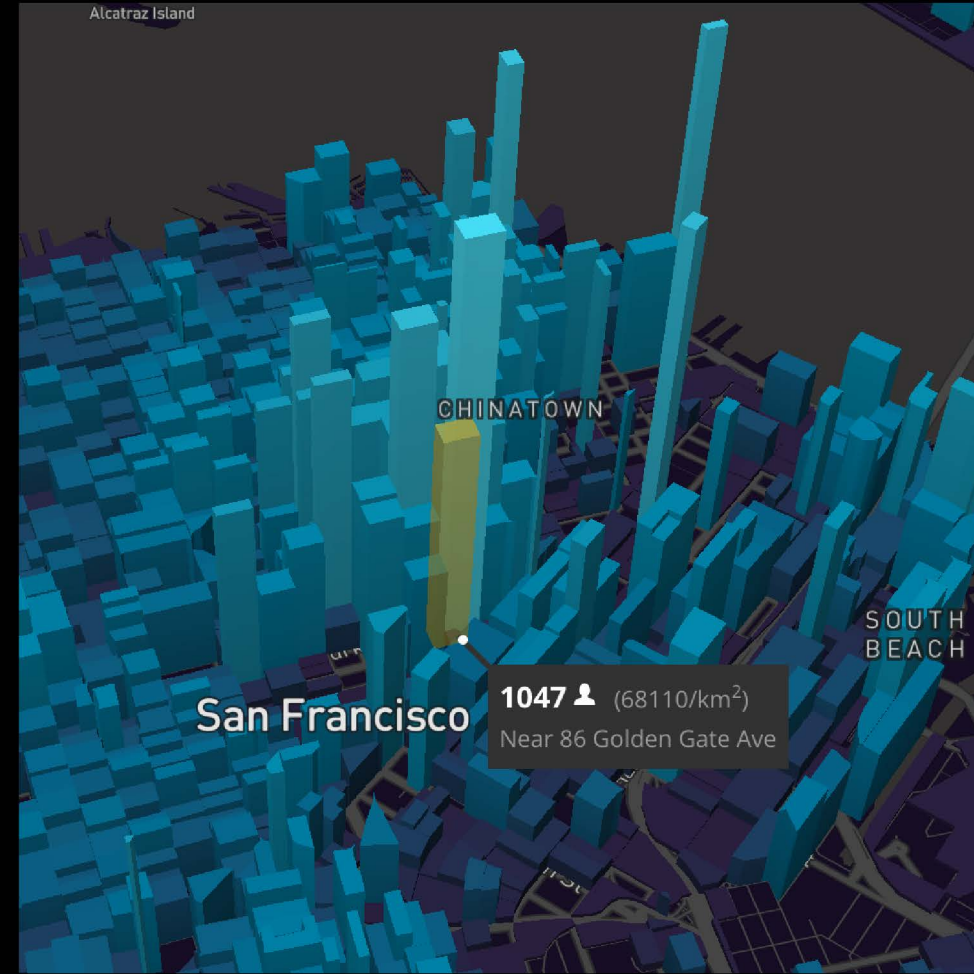
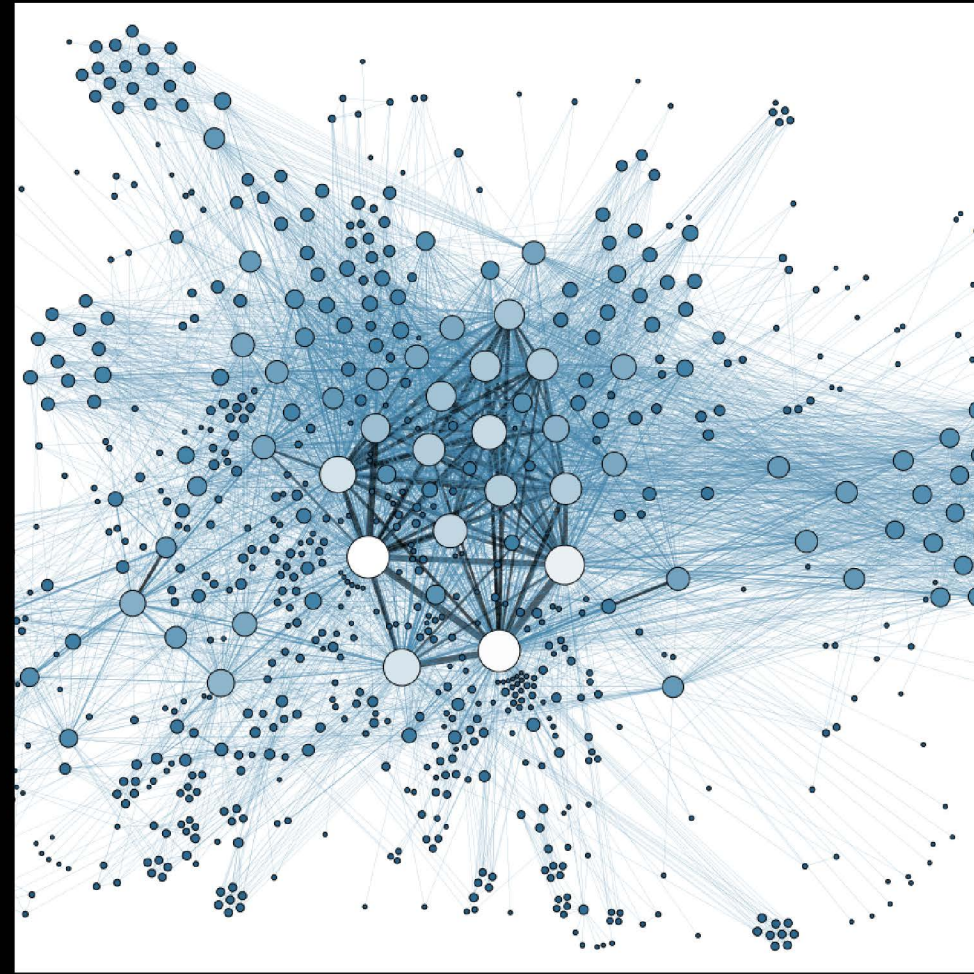

The Hollywood trap

REALITY CHECK

Contemporary datasets are
inherently high-dimensional

Our cognitive system is limited

Even 1,000 rows can feel like
"massive data"

HOWEVER

We tend to put more and more
trust into "black box" models

Lack of intuition makes the user
feel like they're not in control

RELAXING THE PROBLEM CONDITIONS

Interfaces for
developing intuition
for the observed
raw data

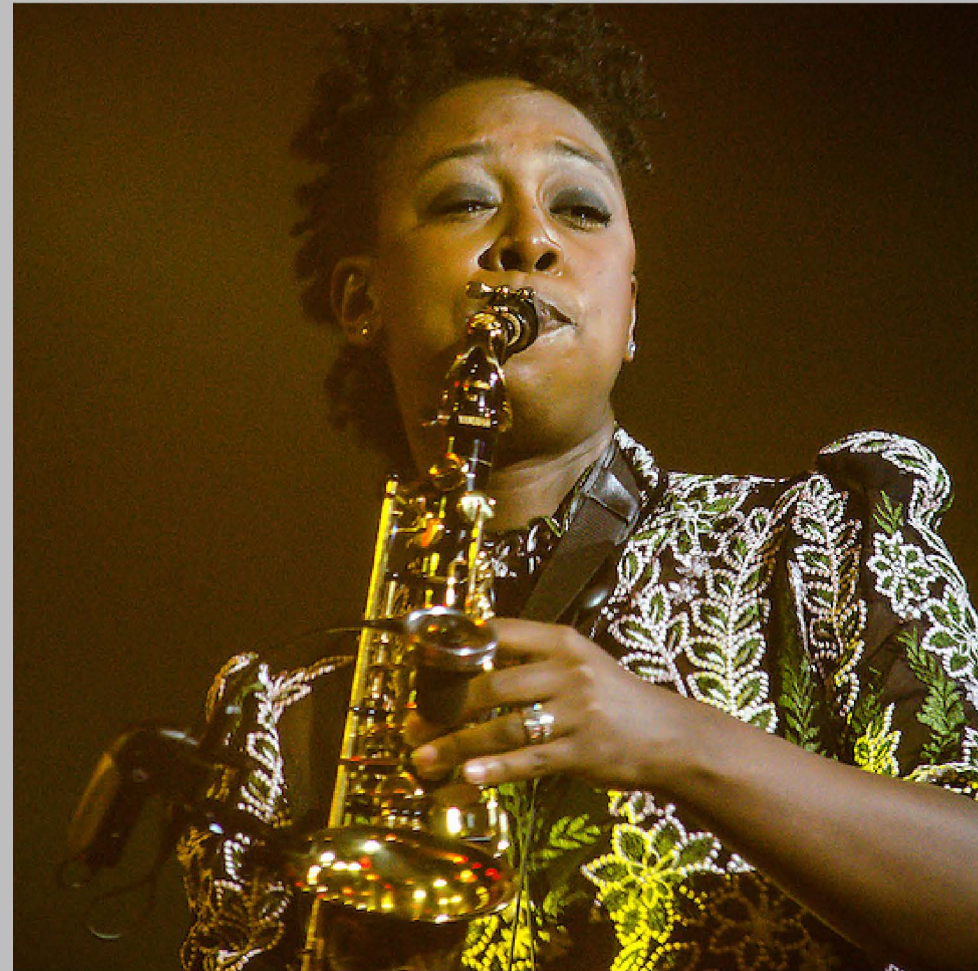

High-dimensional (sonic) space exploration

MIDI DOM Control

Document Object Model (DOM) as the backdrop of most contemporary Human-Data experiences.

MIDI (1982) standardized highly-parallel high-speed human-scale data interface

IDEA

*Mapping MIDI variables to
JavaScript variables
DOM Objects
SVG Elements*

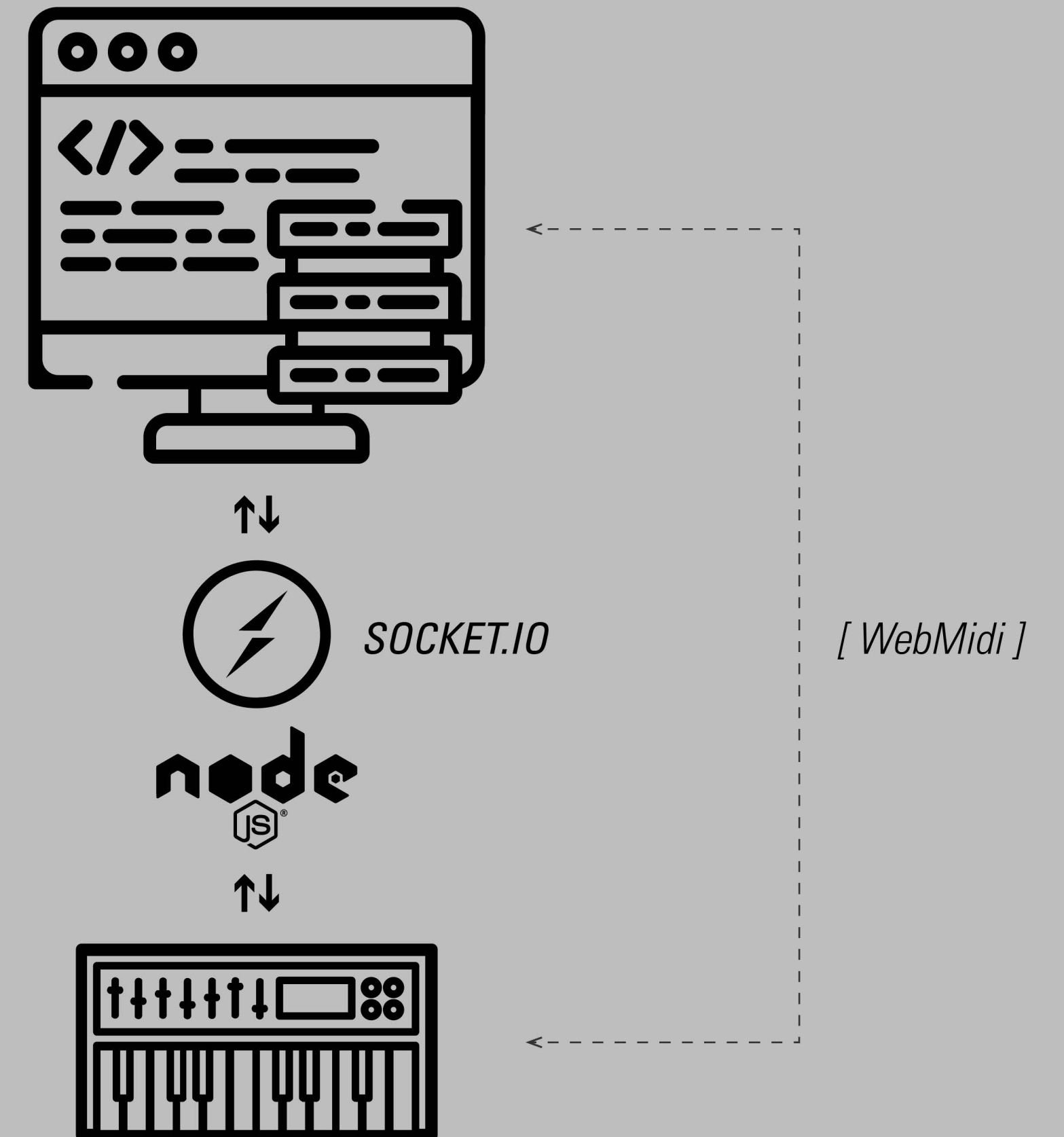

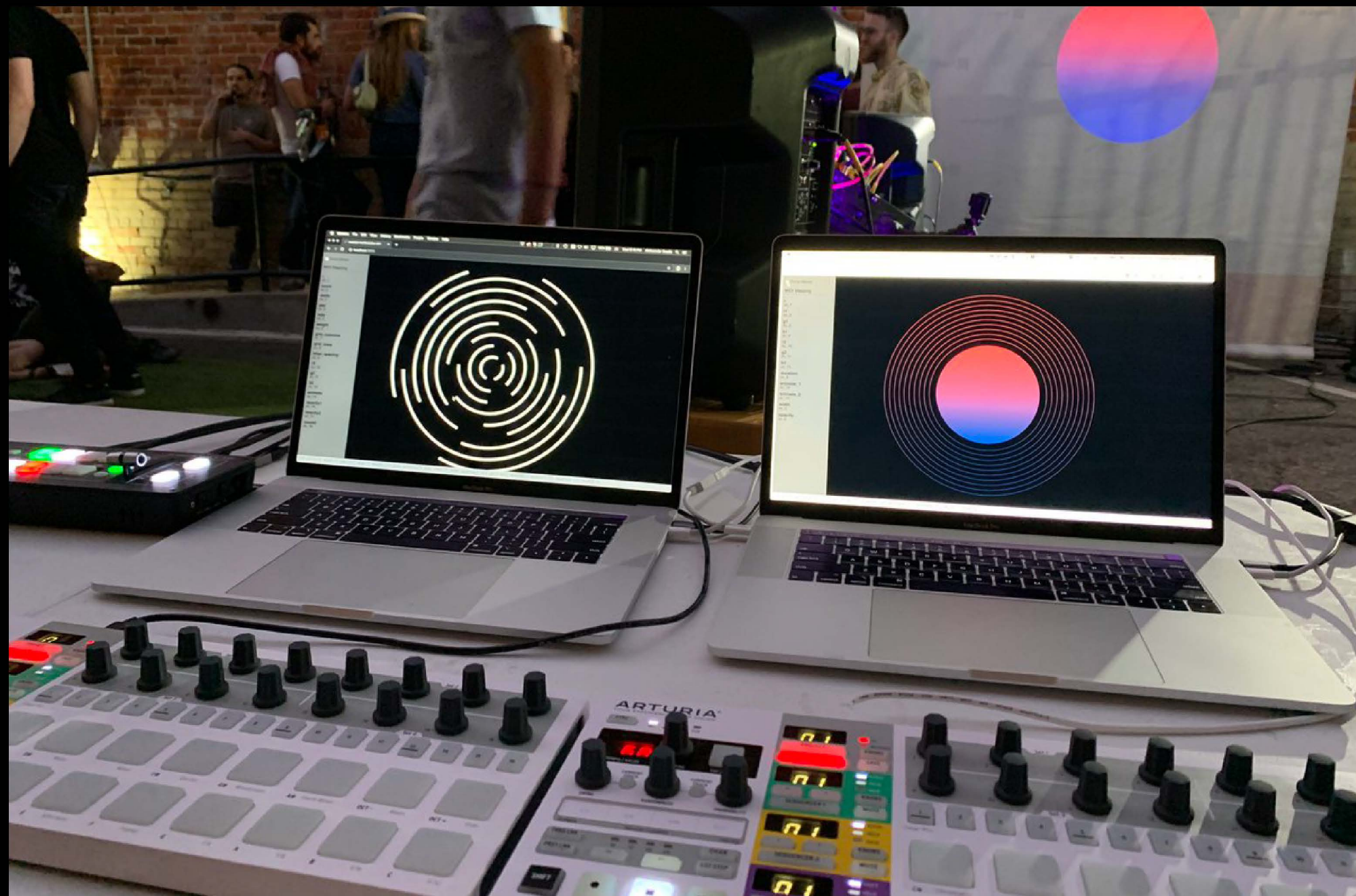
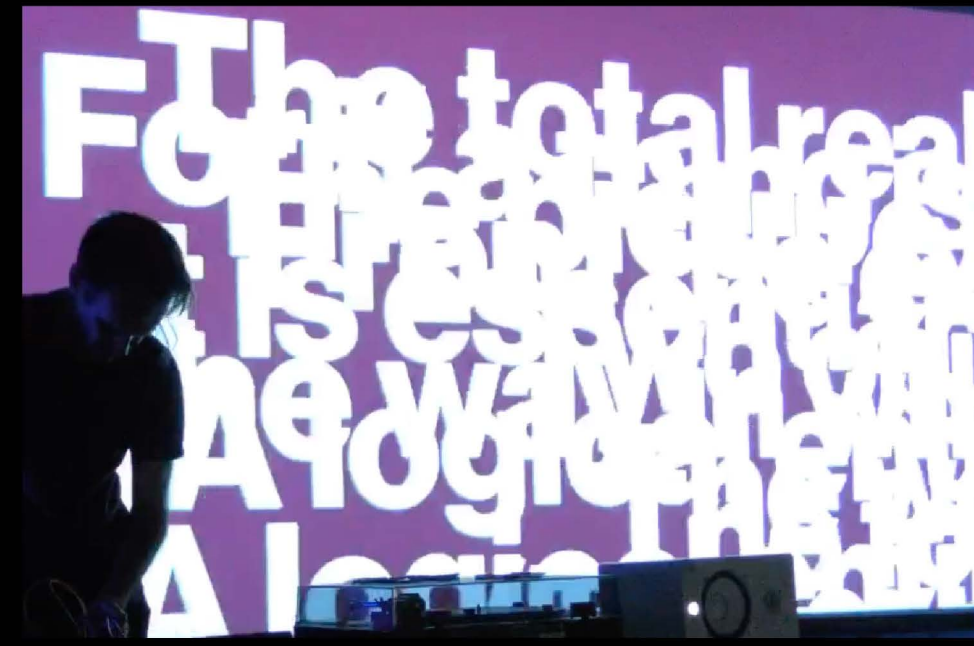
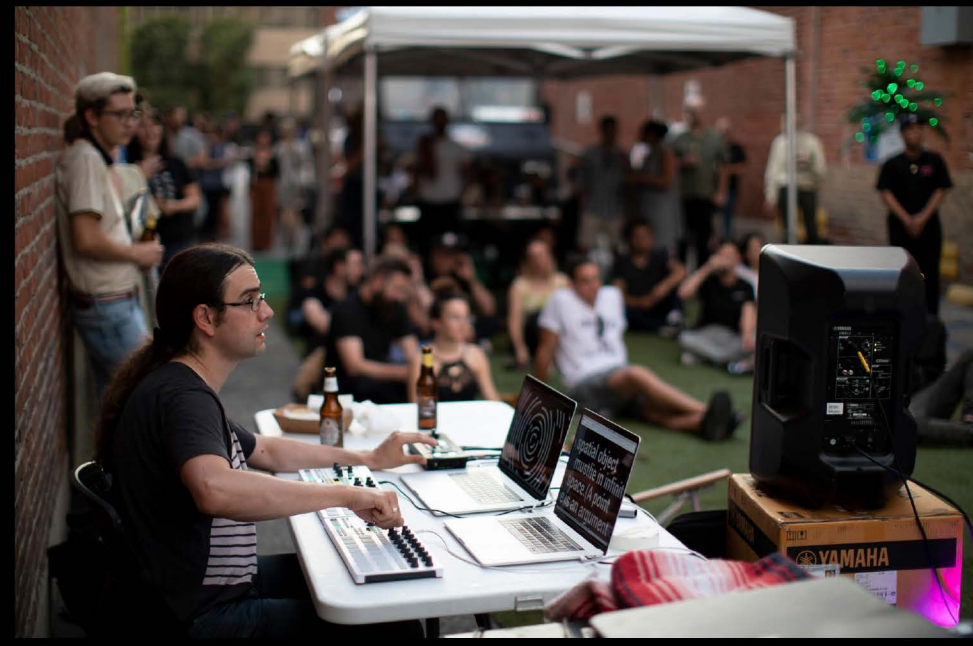
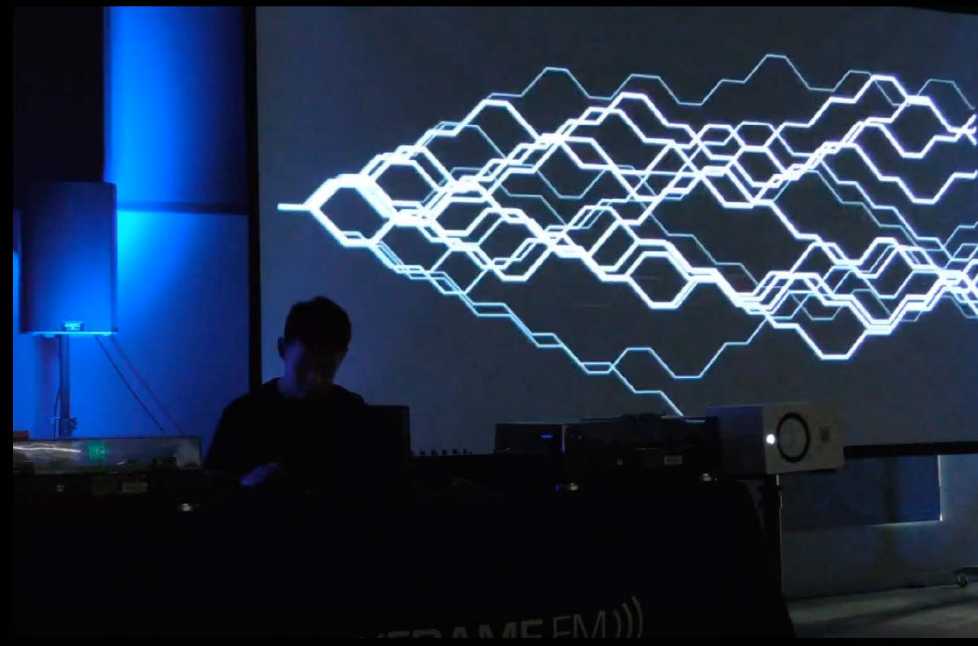

The "Creative Expression" Trap

<p>May v Corbyn on Brexit: the debate over the debate</p> <p>Politics</p> <p>2018-12-01</p>	<p>Foreign Office 'softly-softly' tactics feel heat after Hedges ordeal</p> <p>Politics</p> <p>2018-12-01</p>	<p>Sam Gyimah: second Brexit referendum best option for both sides</p> <p>Politics</p> <p>2018-12-01</p>	<p>Shinzo Abe warns Theresa May to avoid a no-deal Brexit</p> <p>Politics</p> <p>2018-12-01</p>	<p>David Lammy: 'I bounce out of bed to do the job'</p> <p>Politics</p> <p>2018-12-01</p>	<p>Watchdog slams IEA over pro-Brexit report backed by Jacob Rees-Mogg</p> <p>Politics</p> <p>2018-12-01</p>	<p>Kate Osamor: MP resigns amid row over son's drug conviction</p> <p>Politics</p> <p>2018-12-01</p>	<p>May puts on brave face at G20 as Brexit deal flounders back home</p> <p>Politics</p> <p>2018-12-01</p>
<p>Corbyn calls on May to go head to head against him in TV Brexit debate</p> <p>Politics</p> <p>2018-12-01</p>	<p>Key Labour figures urge party to prepare for a new Brexit poll</p> <p>Politics</p> <p>2018-12-01</p>	<p>Letters: 17 MPs call for a second Brexit referendum</p> <p>Politics</p> <p>2018-12-01</p>	<p>Theresa May insists she will be the leader to take UK out of the EU</p> <p>Politics</p> <p>2018-12-02</p>	<p>Even the infamous Tory whips won't try to stop this Brexit rebellion</p> <p>Politics</p> <p>2018-12-02</p>	<p>Bar on low-skilled immigrants will hurt UK, say bosses</p> <p>Politics</p> <p>2018-12-02</p>	<p>How likely is a second referendum?: the rocky, risky road to a people's vote</p> <p>Politics</p> <p>2018-12-02</p>	<p>From no confidence to no deal, the choice for MPs should May's plan fail</p> <p>Politics</p> <p>2018-12-02</p>
<p>Behind closed doors, Labour inches closer to a second referendum</p> <p>Politics</p> <p>2018-12-02</p>	<p>Labour poised to move May confidence motion if she loses Brexit vote</p> <p>Politics</p> <p>2018-12-02</p>	<p>A new vocabulary for Brexit fatigue I Brief letters</p> <p>Politics</p> <p>2018-12-02</p>	<p>Controversial Ukip leader Gerard Batten backed by national executive</p> <p>Politics</p> <p>2018-12-02</p>	<p>Labour questions DfE's £2.5m apprenticeship advertising spend</p> <p>Politics</p> <p>2018-12-02</p>	<p>Brexit TV debate: Tory Brexiters and Lib Dems cry foul over exclusion</p> <p>Politics</p> <p>2018-12-03</p>	<p>Sajid Javid defends noting the ethnicity of child grooming gang</p> <p>Politics</p> <p>2018-12-03</p>	<p>Brexit backstop would be 'practical barrier' to trade deal, leaked paper says</p> <p>Politics</p> <p>2018-12-03</p>
<p>Brexit legal advice and threat of contempt of parliament – explainer</p> <p>Politics</p> <p>2018-12-03</p>	<p>Disabled candidates grant scheme to return for 2019 local elections</p> <p>Politics</p> <p>2018-12-03</p>	<p>Brexit advice summary published amid warnings of backstop row</p> <p>Politics</p> <p>2018-12-03</p>	<p>Not a document to sink the deal – what the Brexit legal advice summary says</p> <p>Politics</p> <p>2018-12-03</p>	<p>Corbyn: May must back up 'warm words' on Saudi Arabia with action</p> <p>Politics</p> <p>2018-12-03</p>	<p>Irish Brexit backstop goes on indefinitely, says attorney general</p> <p>Politics</p> <p>2018-12-03</p>	<p>Opposition parties launch joint contempt proceedings against ministers over Brexit legal advice – as it happened</p> <p>Politics</p> <p>2018-12-03</p>	<p>Geoffrey Cox milks his moment in Commons spotlight I John Grace</p> <p>Politics</p> <p>2018-12-03</p>
<p>Can the UK get an extension on Brexit?</p> <p>Politics</p> <p>2018-12-04</p>	<p>Voter ID trials in England face legal challenge</p> <p>Politics</p> <p>2018-12-04</p>	<p>Brexit weekly briefing: Theresa May tries to sell her deal to the country</p> <p>Politics</p> <p>2018-12-04</p>	<p>Brexit: senior minister could be suspended over legal advice</p> <p>Politics</p> <p>2018-12-04</p>	<p>Rival Brexit debates planned as Corbyn and May can't agree on format</p> <p>Politics</p> <p>2018-12-04</p>	<p>Toyota: no-deal Brexit may cost up to £10m a day in lost production</p> <p>Politics</p> <p>2018-12-04</p>	<p>What happens next if Theresa May's Brexit deal is voted down?</p> <p>Politics</p> <p>2018-12-04</p>	<p>Norway option is worst of all Brexit outcomes for UK, say EU sources</p> <p>Politics</p> <p>2018-12-04</p>
<p>month 12</p> <p>year 2018</p> <p>section Politics</p>							



The Guardian MIDI/CC Browser

Yet Another Data Glove*

**A MIDI Data Glove Interface*

IDEA

From Scratch Built

V1: Computer Vision-based

V2: Gyroscope/Accelerometer based

V3: Good old variable resistors

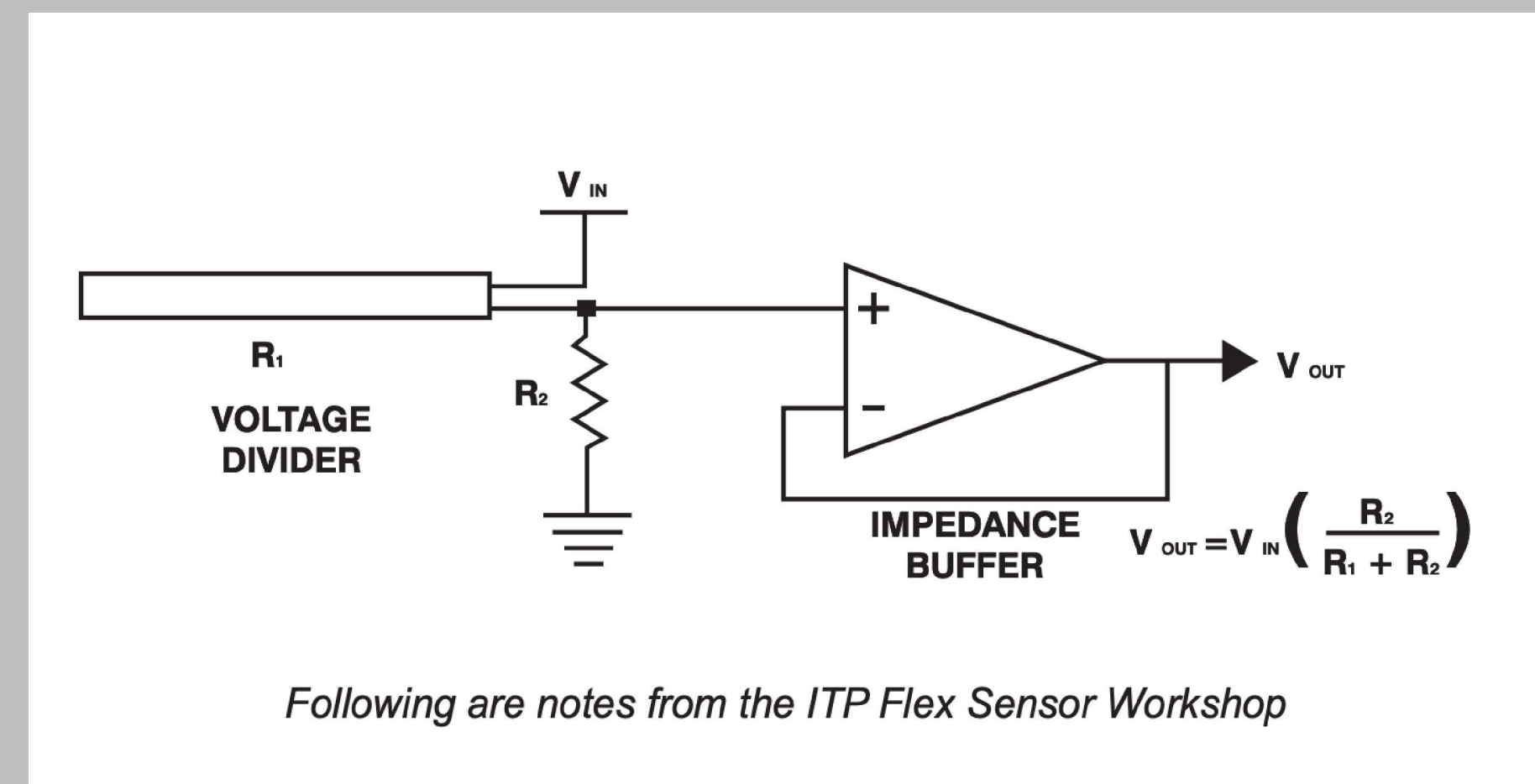
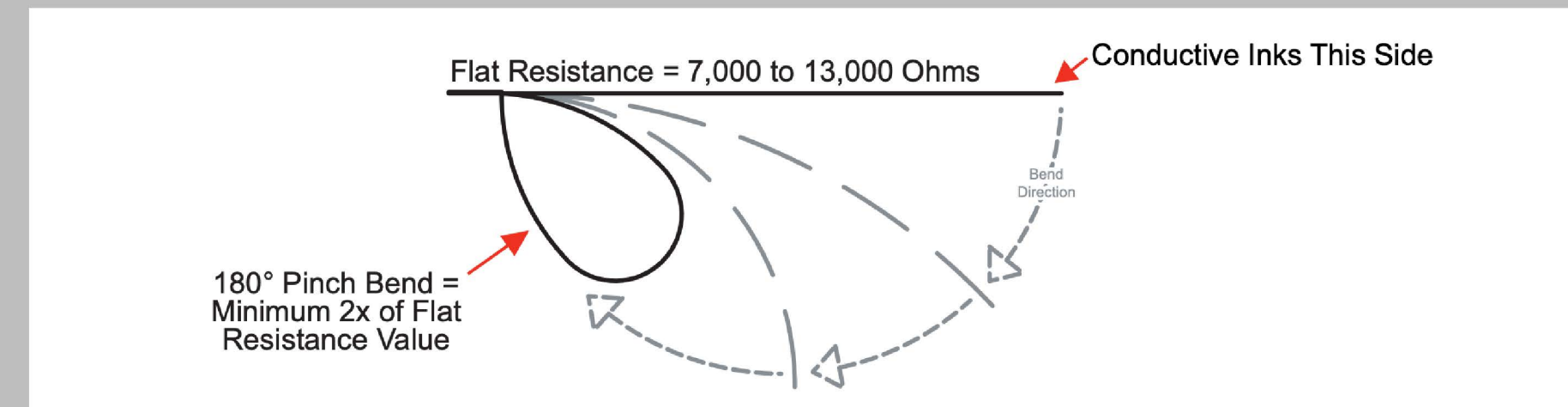

FS-L-095-103-ST Flex Sensor

\$21.00 - \$12.1/per

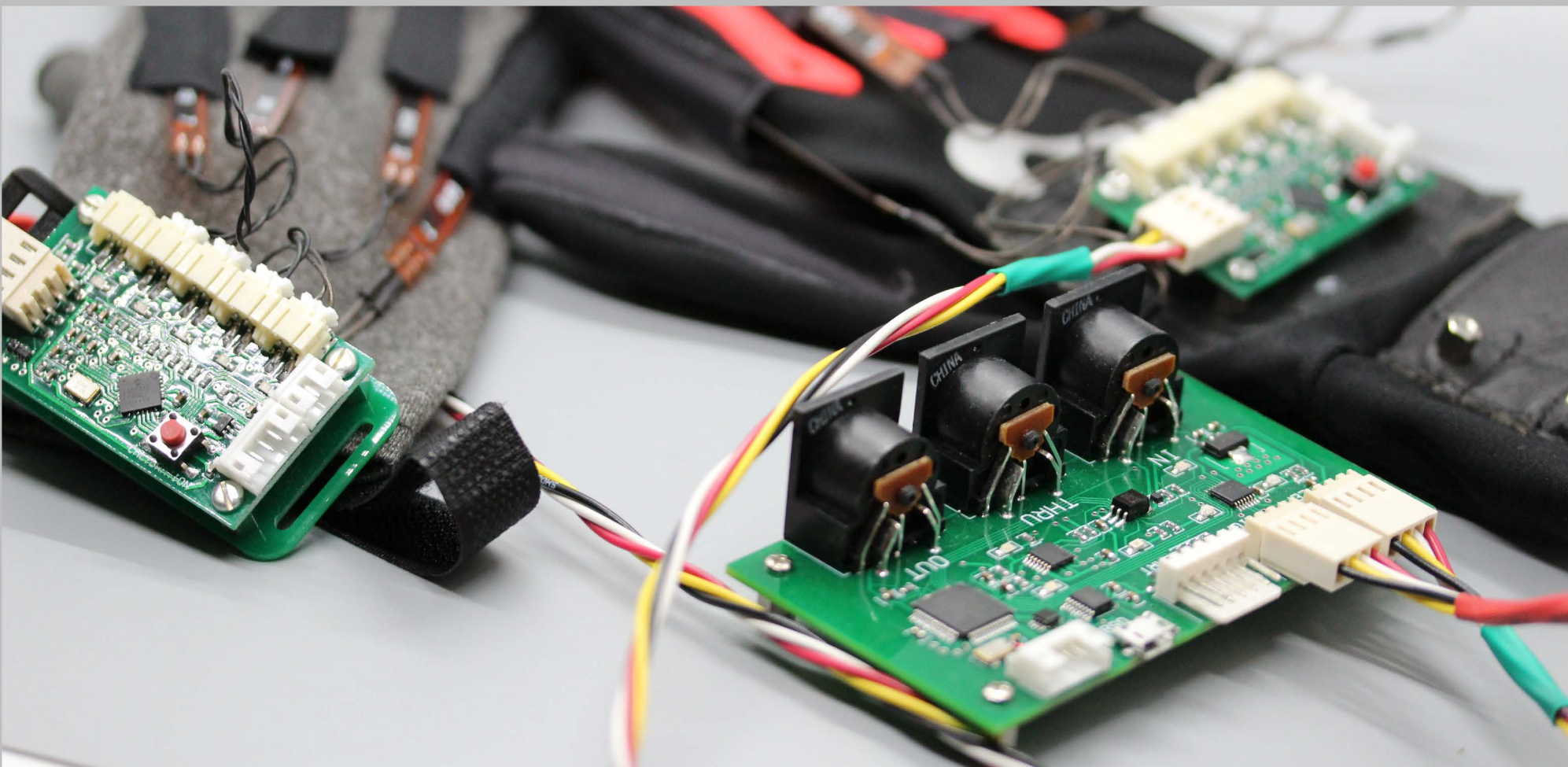
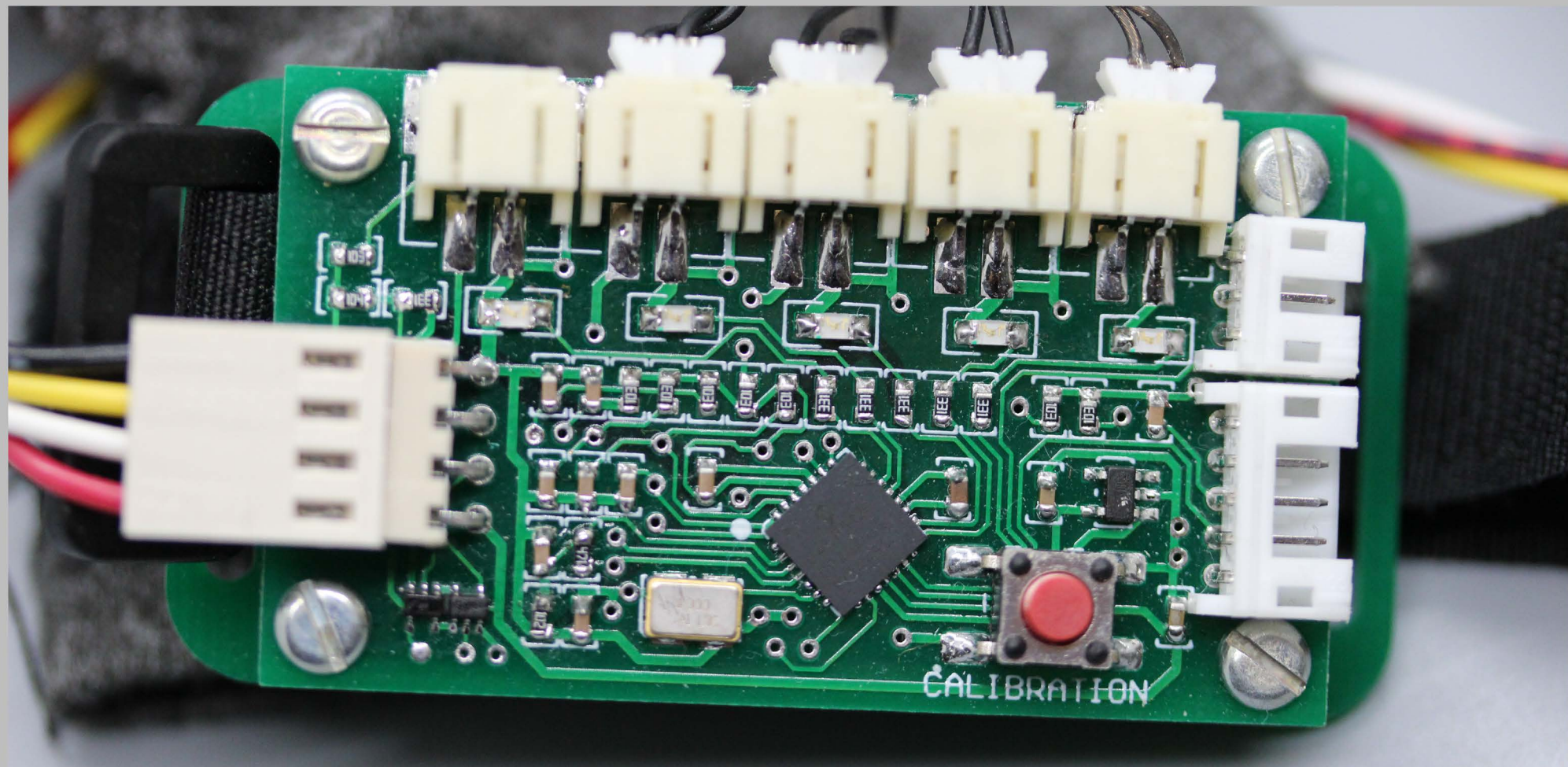
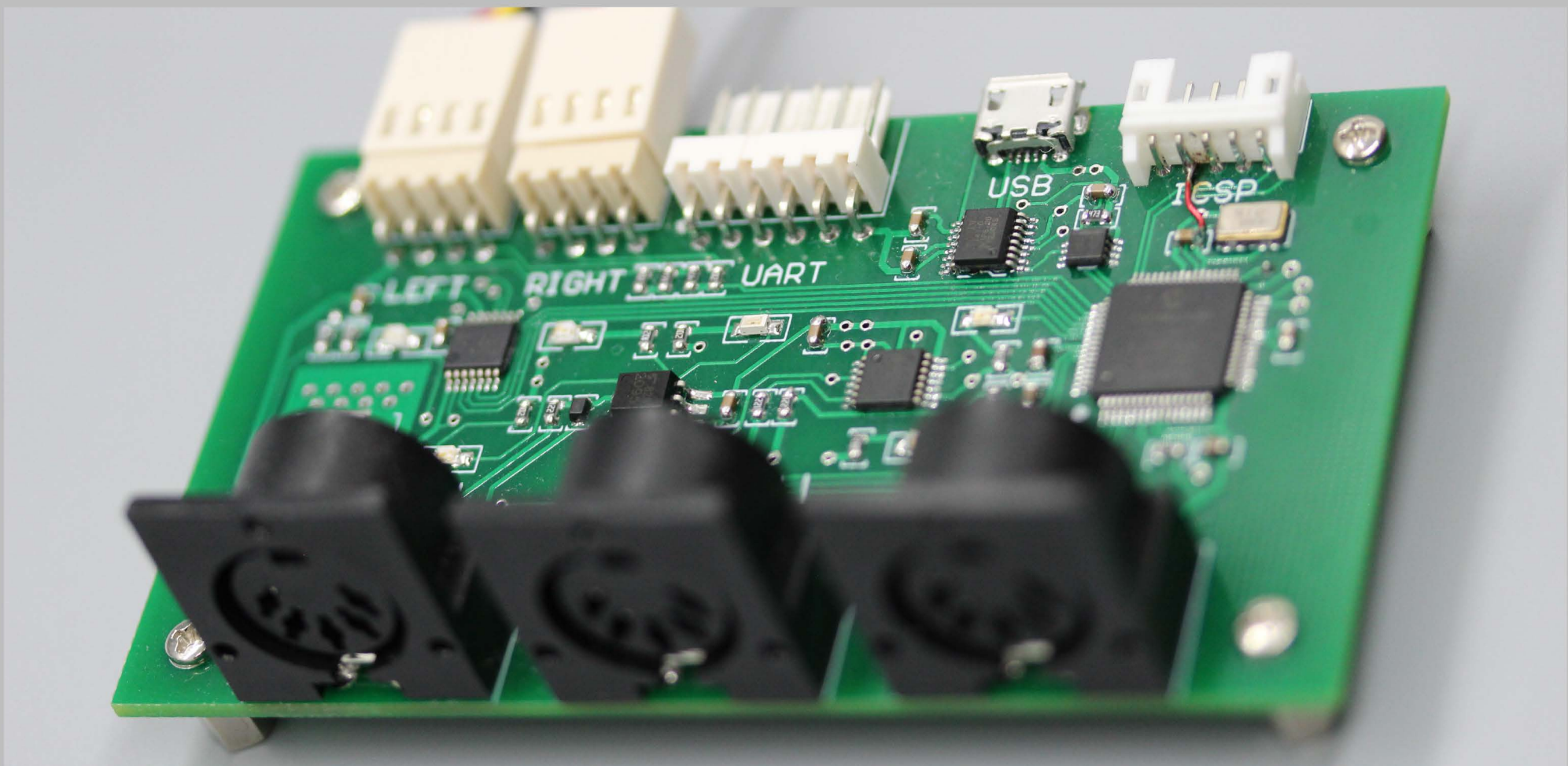
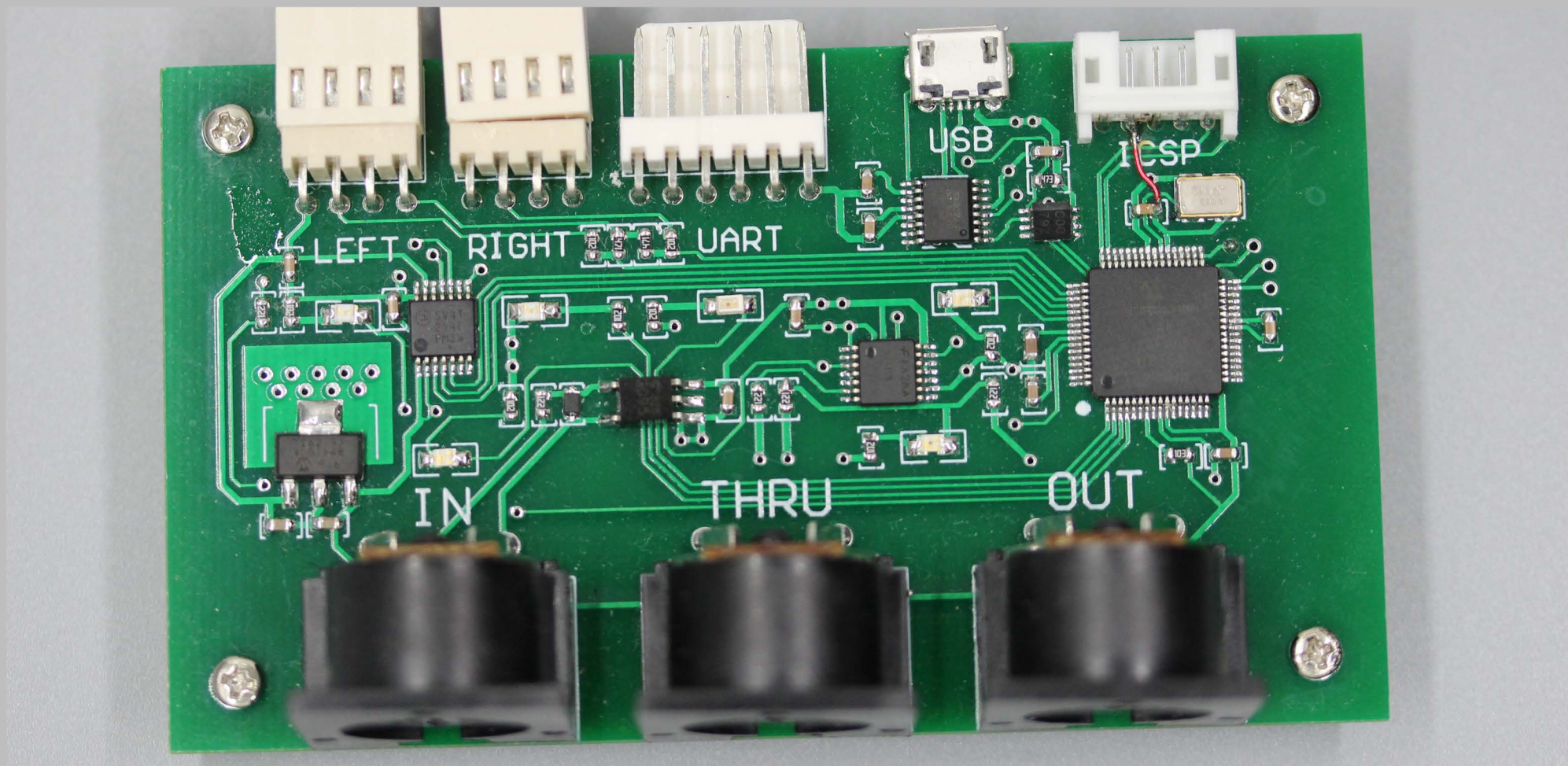

Board Design: Voja Antonic

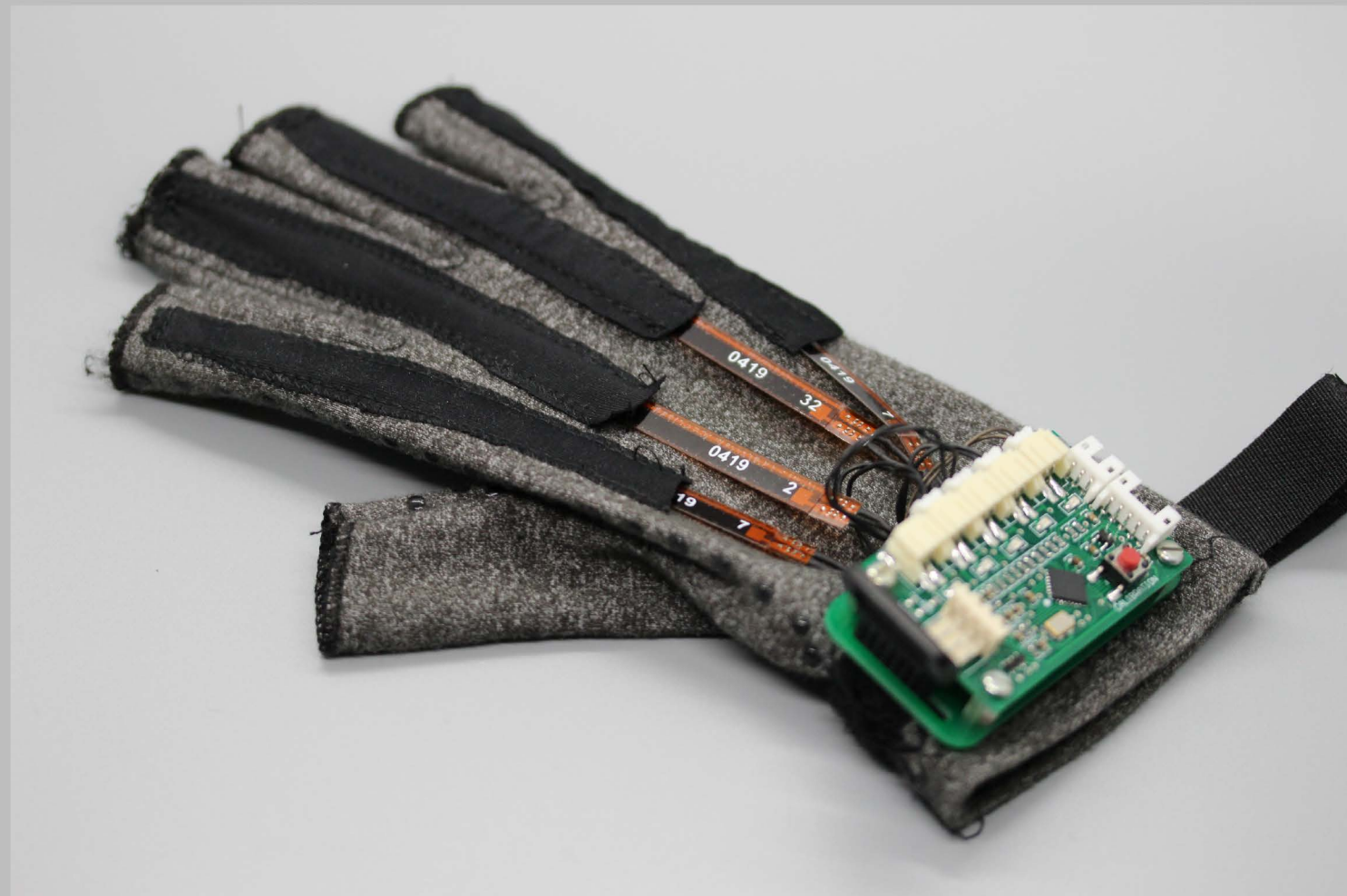

UTILITARIAN



TECHWEAR



WARM & FUZZY

Glove Design: Majenta Strongheart

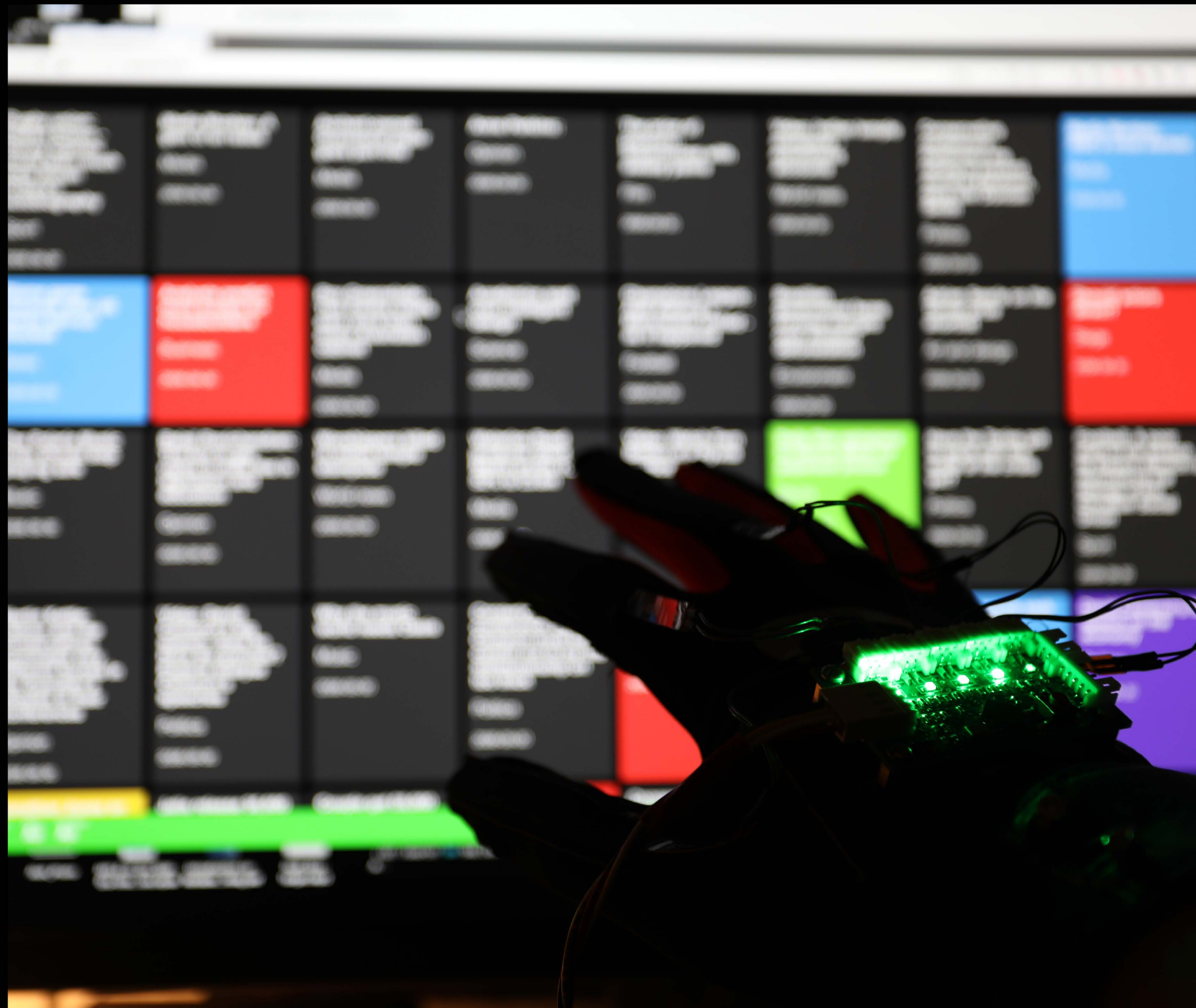

UX Breakdown

Control variables change continuously, causing the UX to "oscillate."

Adding a signal filter smooths out the changes, but the Lucene backend can't match the required < 20ms response time needed to "keep up."

Information is too "dense," with no clear visual hierarchy, making it hard to interpret the rapidly-changing scene in a meaningful way.

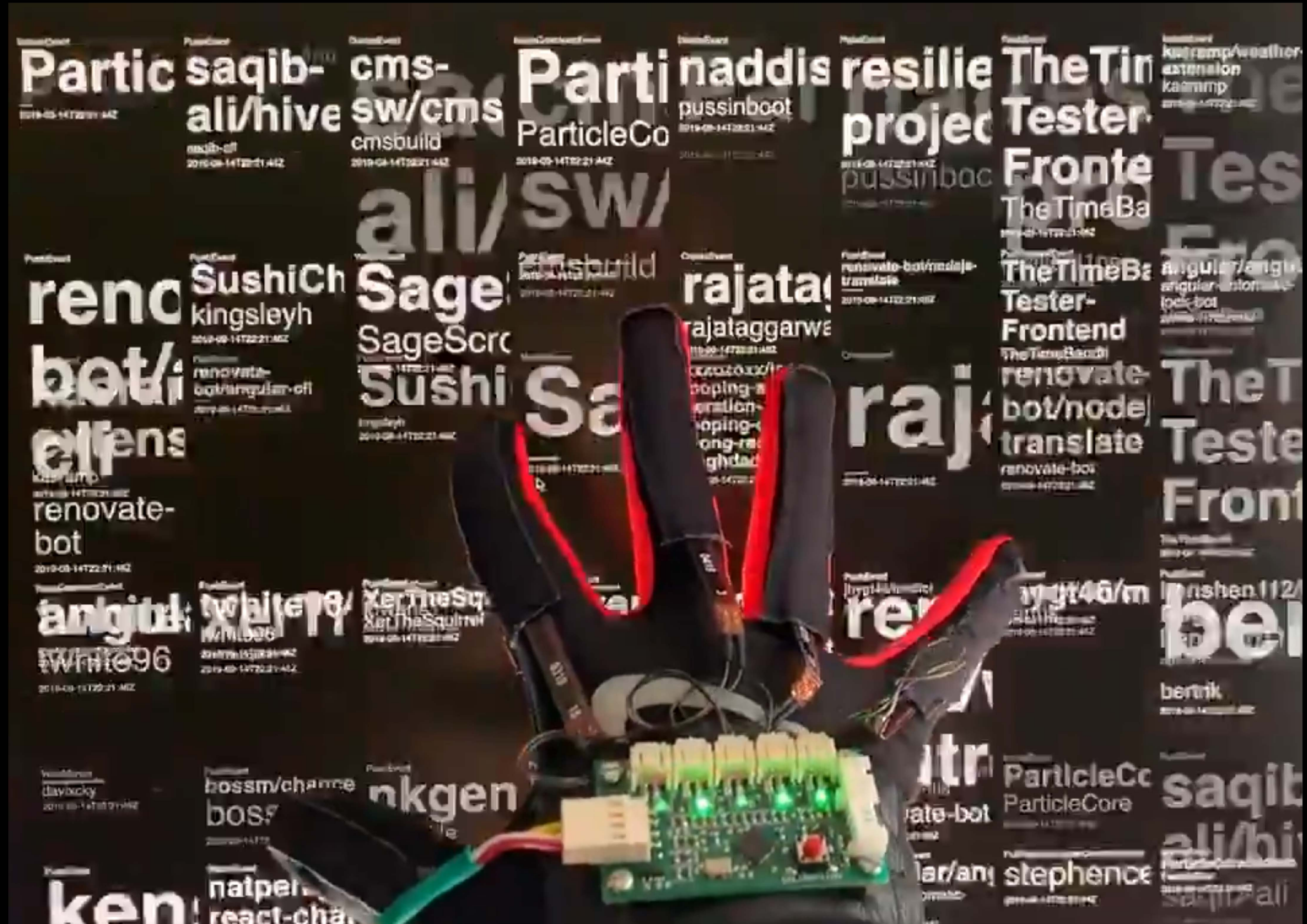
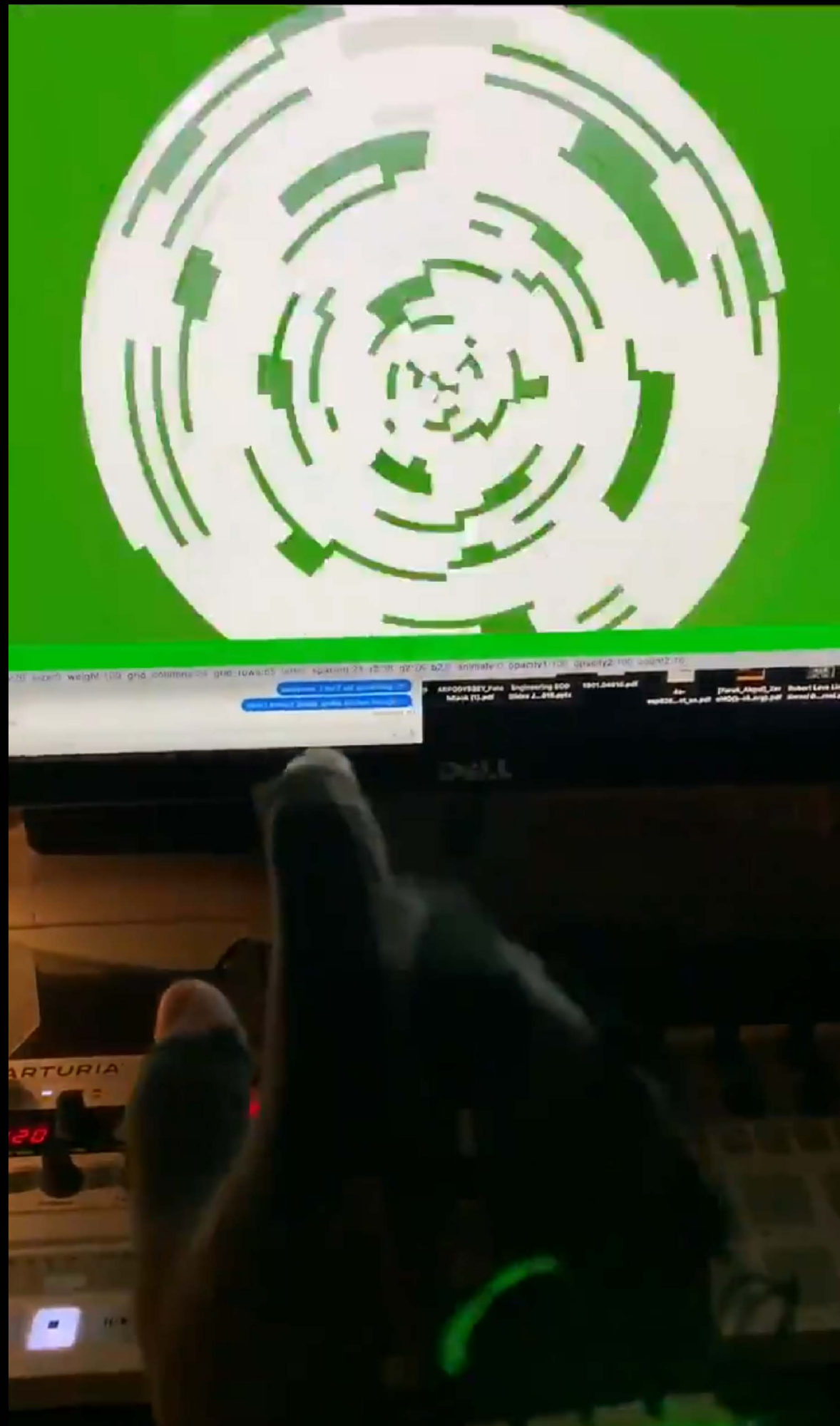

"Creative Expression" Trap Redux

Try Again.
Fail Again.
Fail Better.*

— *Samuel Beckett, Worstward Ho*

ASSUMPTIONS REDUX

Data Visualization might not be the answer.

Whitespace might not be the enemy.

Visual hierarchy matters for a reason.

FOLDERS

- twitter-data-export
 - direct_message_media
 - profile_media
 - tweet_media
 - /* account-creation-ip.js
 - /* account-suspension.js
 - /* account-timezone.js
 - /* account.js
 - /* ad-engagements.js
 - /* ad-impressions.js
 - /* ad-mobile-conversions-attributed.js
 - /* ad-mobile-conversions-unattributed.js
 - /* ad-online-conversions-attributed.js
 - /* ad-online-conversions-unattributed.js
 - /* ageinfo.js
 - /* block.js
 - /* connected-application.js
 - /* contact.js
 - /* device-token.js
 - /* direct-message-group-headers.js
 - /* direct-message-group.js
 - /* direct-message-headers.js
 - /* direct-message.js
 - /* email-address-change.js
 - /* follower.js
 - /* following.js
 - /* ip-audit.js
 - /* like.js
 - /* lists-created.js
 - /* lists-member.js
 - /* lists-subscribed.js
 - /* moment.js
 - /* mute.js
 - /* ni-devices.js
 - /* periscope-account-information.js
 - /* periscope-broadcast-metadata.js
 - /* periscope-comments-made-by-user.js
 - /* periscope-expired-broadcasts.js
 - /* periscope-followers.js
 - /* periscope-profile-description.js
 - /* personalization.js
 - /* phone-number.js
 - /* profile.js

```
ad-impressions.js
1 window.YTD.ad_impressions.part0 = [ {
2   "ad" : {
3     "adsUserData" : {
4       "adImpressions" : {
5         "impressions" : [ {
6           "deviceInfo" : {
7             "osType" : "Ios",
8             "deviceId" : "vRFgsz6n0fwiuxp0Gg62UJ0vRc+N0+uxc0Xxtjcz6h8=",
9             "deviceType" : "iPhone XS"
10          },
11          "displayLocation" : "TimelineHome",
12          "promotedTweetInfo" : {
13            "tweetId" : "1133465417618460673",
14            "tweetText" : "Grab a bag of kettle-cooked chips and turn on your mental out-of-office. #CapeCodStateOfMind https://t.co/hX3uEuN7AS",
15            "urls" : [ ],
16            "mediaUrls" : [ "https://t.co/hX3uEuN7AS" ]
17          },
18          "advertiserInfo" : {
19            "advertiserName" : "Cape Cod Chips",
20            "screenName" : "@CapeCodChips"
21          },
22          "matchedTargetingCriteria" : [ {
23            "targetingType" : "Behaviors",
24            "targetingValue" : "US - Salty snacks: Tostitos"
25          }, {
26            "targetingType" : "Age",
27            "targetingValue" : "25 to 54"
28          }, {
29            "targetingType" : "Locations",
30            "targetingValue" : "Monterey-Salinas CA, US"
31          } ],
32          "impressionTime" : "2019-06-24 15:02:40"
33        }, {
34          "deviceInfo" : {
35            "osType" : "Ios",
36            "deviceId" : "vRFgsz6n0fwiuxp0Gg62UJ0vRc+N0+uxc0Xxtjcz6h8=",
37            "deviceType" : "iPhone XS"
38          },
39          "displayLocation" : "TimelineHome",
40          "promotedTweetInfo" : {
41            "tweetId" : "1133405896699129856",
42            "tweetText" : "RT @HIExpress: Our Global Sale is here. Save at least 20%* at Holiday Inn Express-members save even more. *Terms Apply",
43            "urls" : [ ],
44            "mediaUrls" : [ ]
45          },
46          "advertiserInfo" : {
47            "advertiserName" : "IHG Hotels & Resorts",
48            "screenName" : "@IHG"
49          },
50          "matchedTargetingCriteria" : [ {
51            "targetingType" : "Conversation topics",
52            "targetingValue" : "Holiday Inn"
53          }, {
54            "targetingType" : "Tailored audiences (lists)",
55            "targetingValue" : "Spire_Member_1_14295239"
56          }, {
57            "targetingType" : "Tailored audiences (lists)",
58            "targetingValue" : "1PD: GoldMember_1_29379439"
59          }, {
60            "targetingType" : "Tailored audiences (lists)",
61            "targetingValue" : "1PD: ClubMember_1_29379369"
62          }, {
63            "targetingType" : "Tailored audiences (lists)",
```

Match between system and the real world

Visibility of system status

User control and freedom

EVENT QUEUE
Entries processed: 14 | Entries remaining: 5,298

TARGETING CRITERIA
Behaviors: US - Salty snacks: Tostitos
Age: 25 to 54
Locations: Monterey-Salinas CA, US

2019-06-24 16:19:02
iPhone XS

Cape Cod Chips
Grab a bag of kettle-cooked chips and turn on your mental out-of-office.
#CapeCodStateOfMind
<https://t.co/hX3uEuN7AS>

EVENT HISTORY

- 2019-06-24 16:34:11
iPhone XS
Postmates
When your human Postmates your favorites.
- 2019-06-24 16:19:02
iPhone XS
Cape Cod Chips
Grab a bag of kettle-cooked chips and turn on your mental out-of-office.
#CapeCodStateOfMind
<https://t.co/hX3uEuN7AS>
- 2019-06-24 16:19:04
iPhone XS
natural bliss®
natural bliss is made with only simple, real ingredients you love. Like farm fresh milk and cream, pure cane sugar, and Madagascar vanilla. <https://t.co/zDb2mOfbyC>

TWITTER AD IMPRESSION HISTORY BROWSER

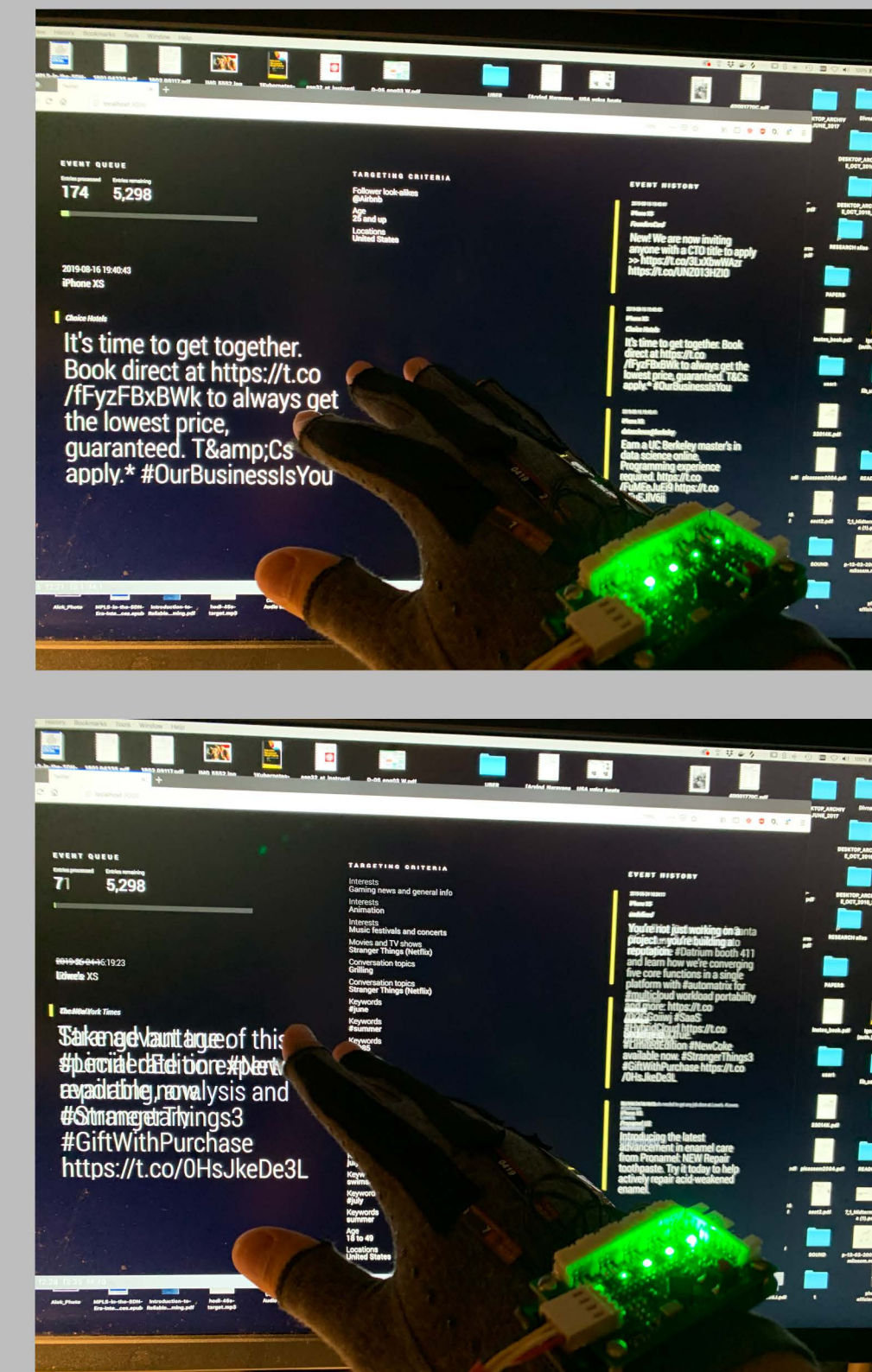

Takeaways*

Fast iteration of low information density scenes, with clear visual hierarchy, might be superior to "information visualization."

Muscular control of the information flow strengthens the sense of agency and might help stitch together visual stimuli into a **consistent narrative**.

Direct engagement with individual "data points" can create a sense of **empathy** in a way that can't be matched by data aggregates and statistics.

Exploring hardware "data interfaces" can help explore gaps in existing software stacks, generate **new requirements**, and drive product innovation in critical fields of Cloud Computing, Big Data, and AI.

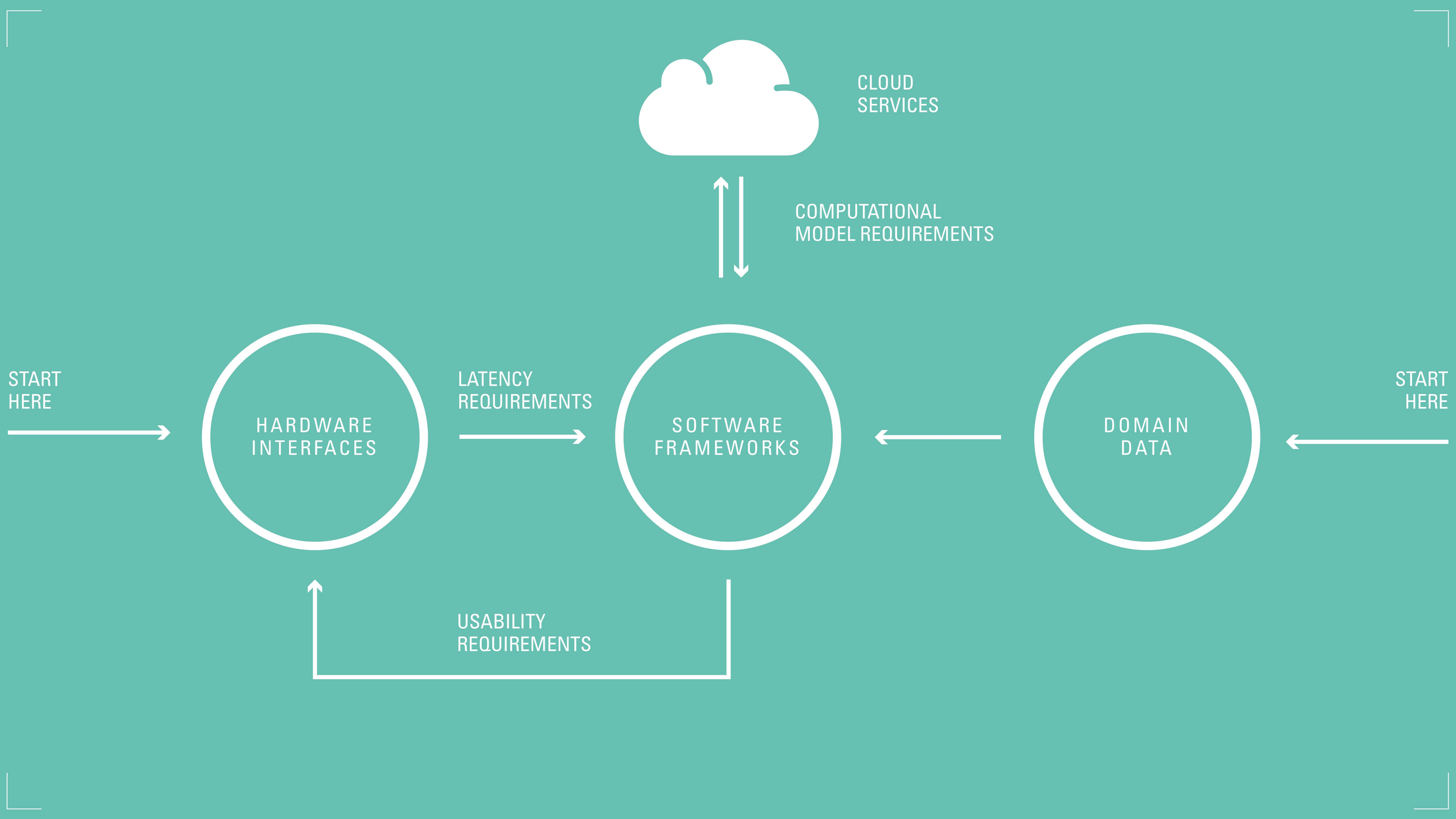

START
HERE

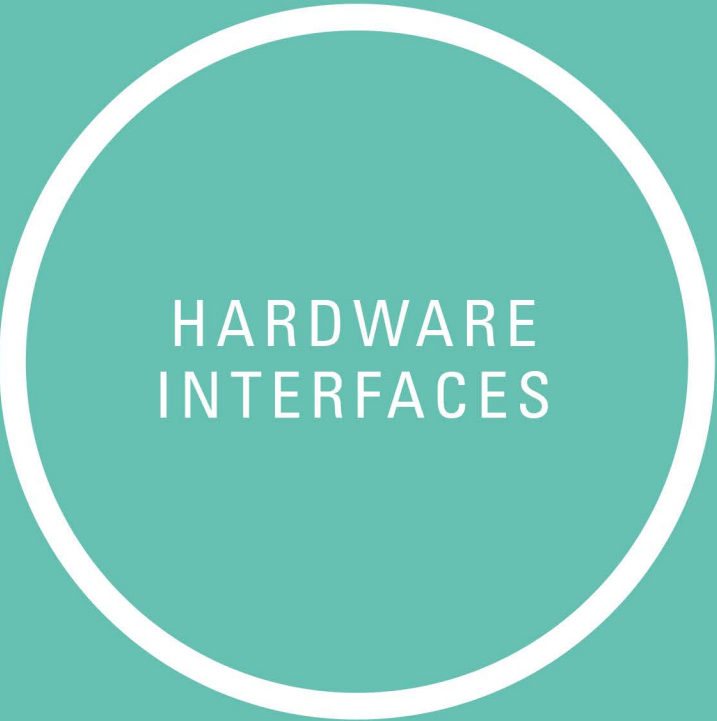

LATENCY
REQUIREMENTS



START
HERE

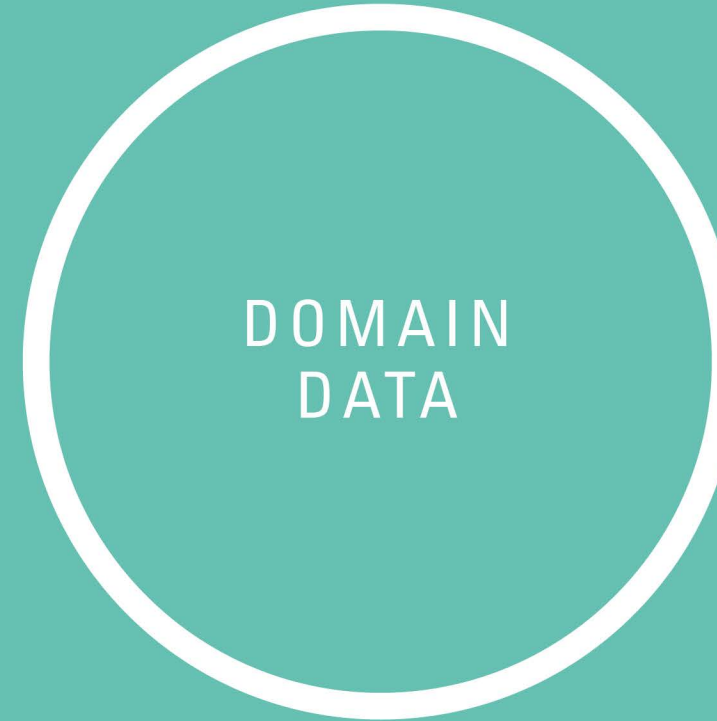

START
HERE



CLOUD
SERVICES



COMPUTATIONAL
MODEL REQUIREMENTS



USABILITY
REQUIREMENTS

Links

TOP LEVEL PROJECT

hackaday.io/project/167793-dom-glove

DOM MIDI CONTROL FRAMEWORK

github.com/alek/bleep

#DATAINTERFACES RANTS

twitter.com/randomwalks

