

Title		
Size	Number	Revision
A4		
Date:	10.11.2019	Sheet of
File:	D:\Buck\...\hex2.SchDoc	Drawn By:

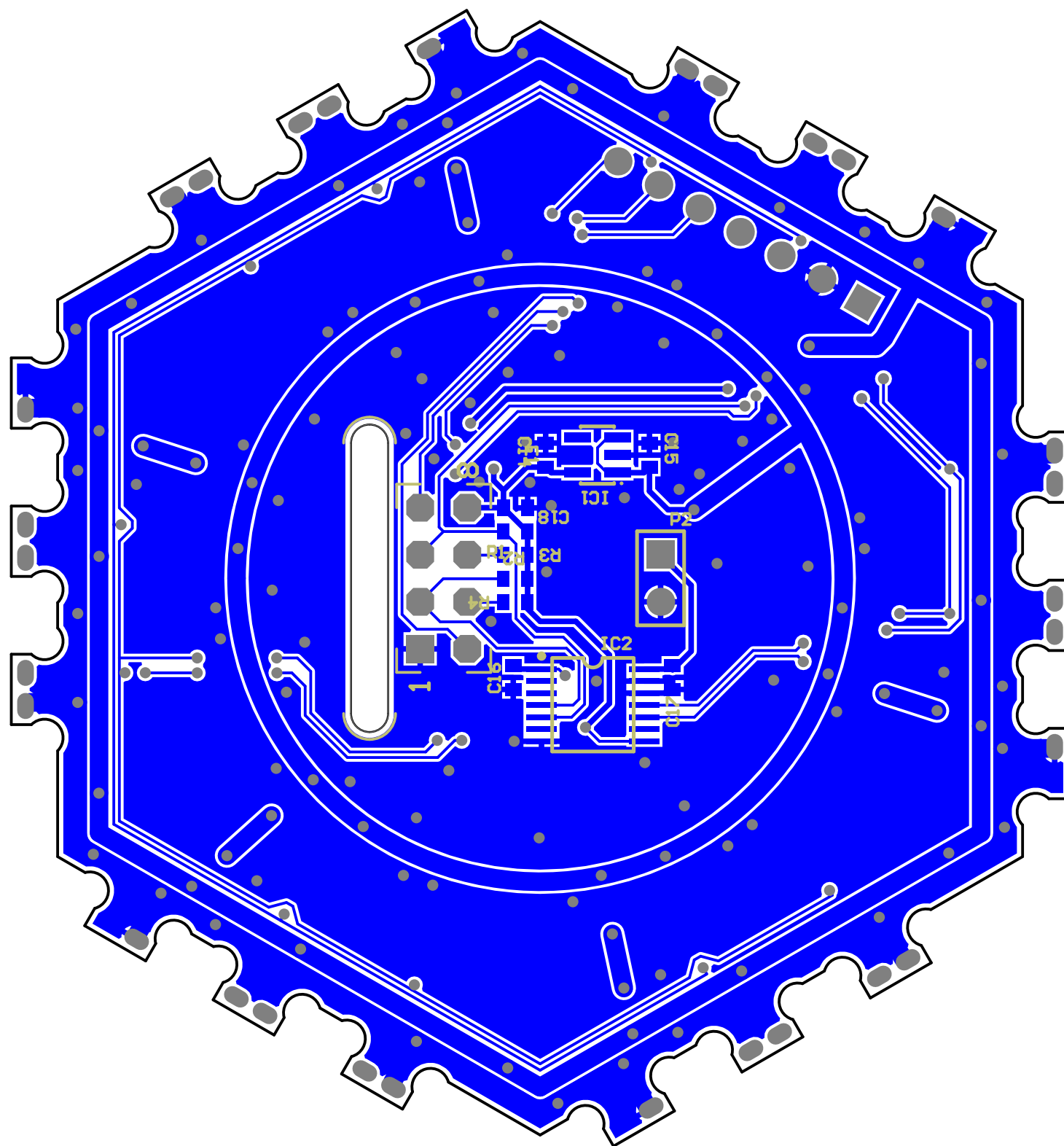

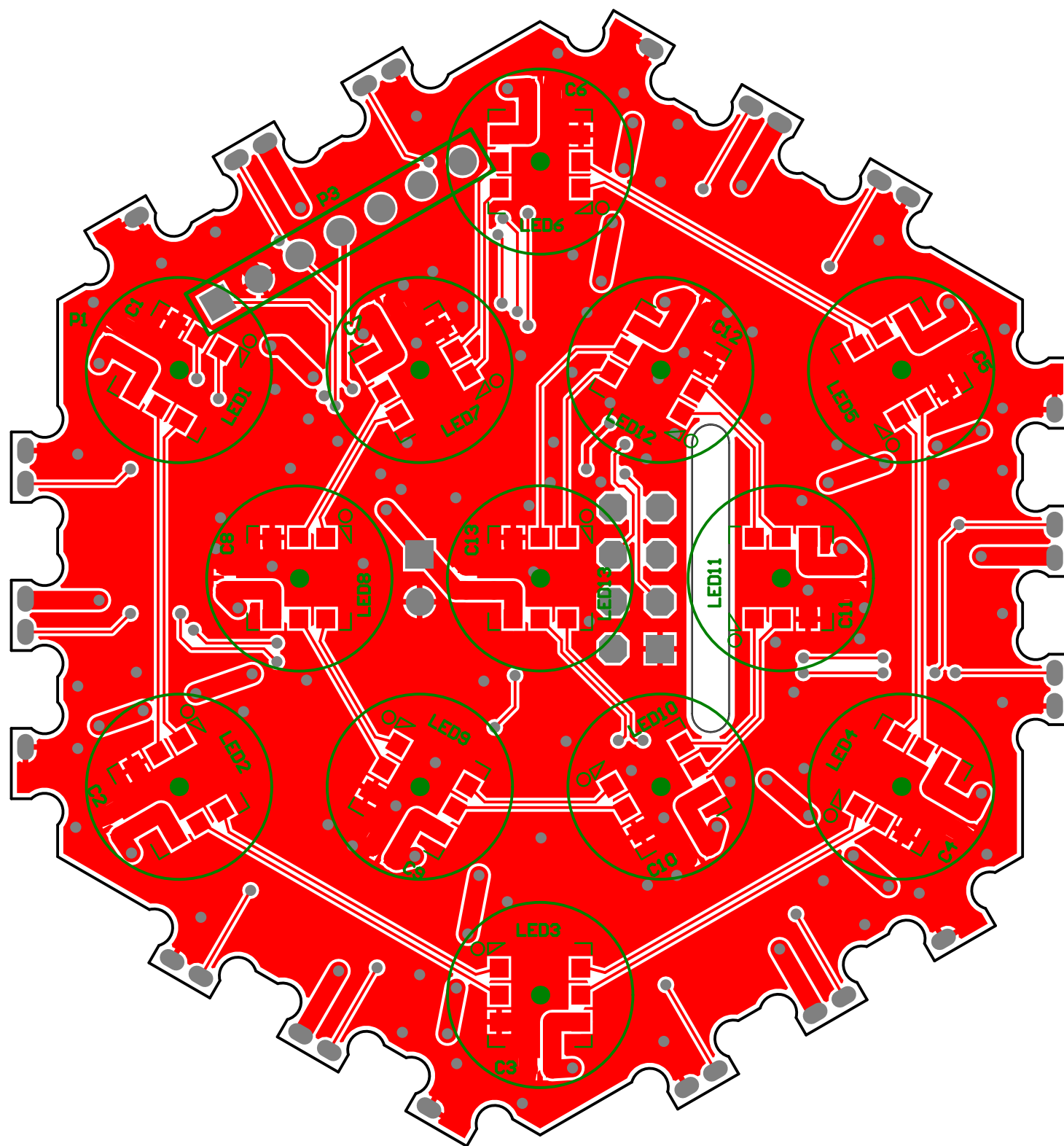

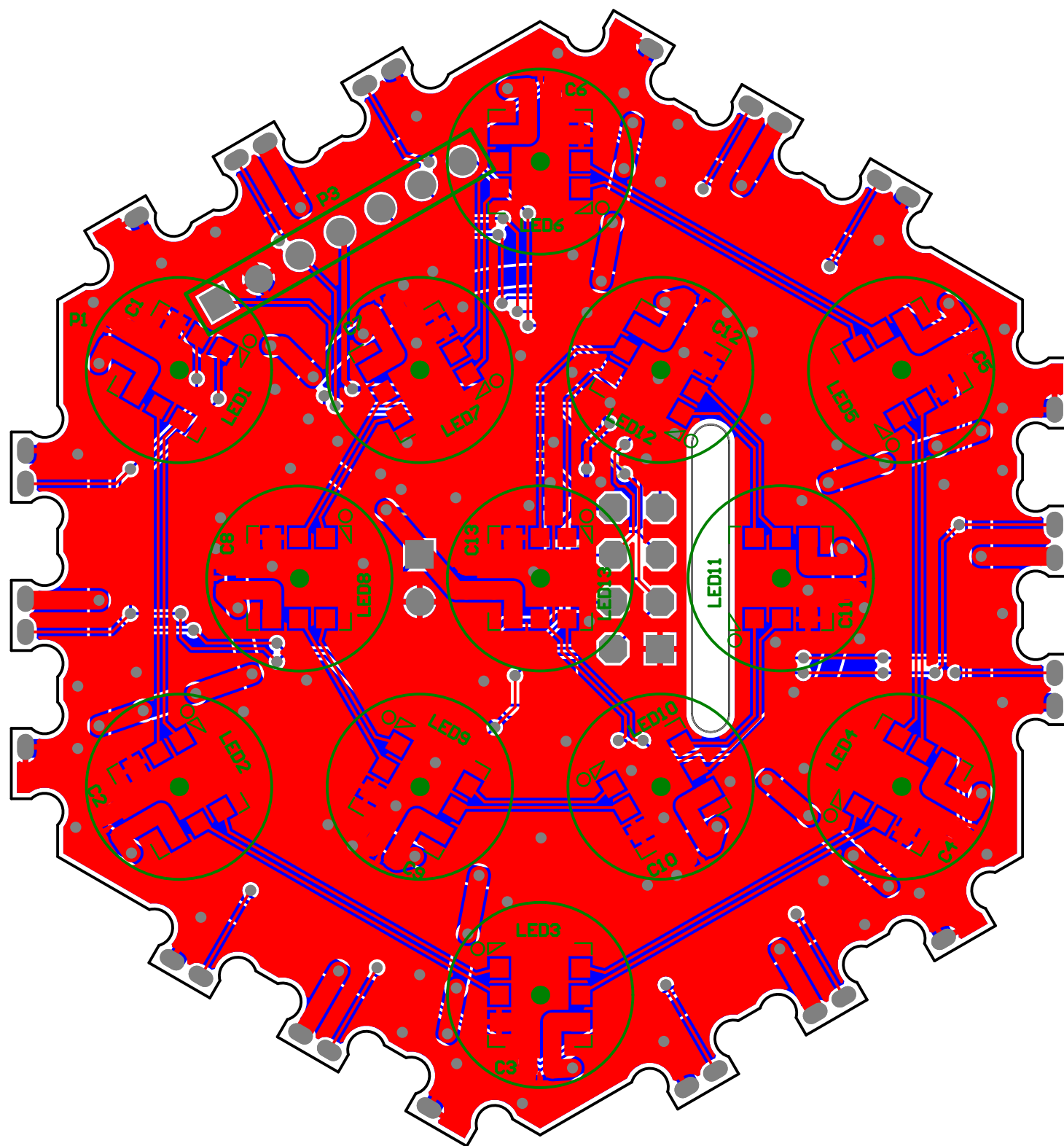

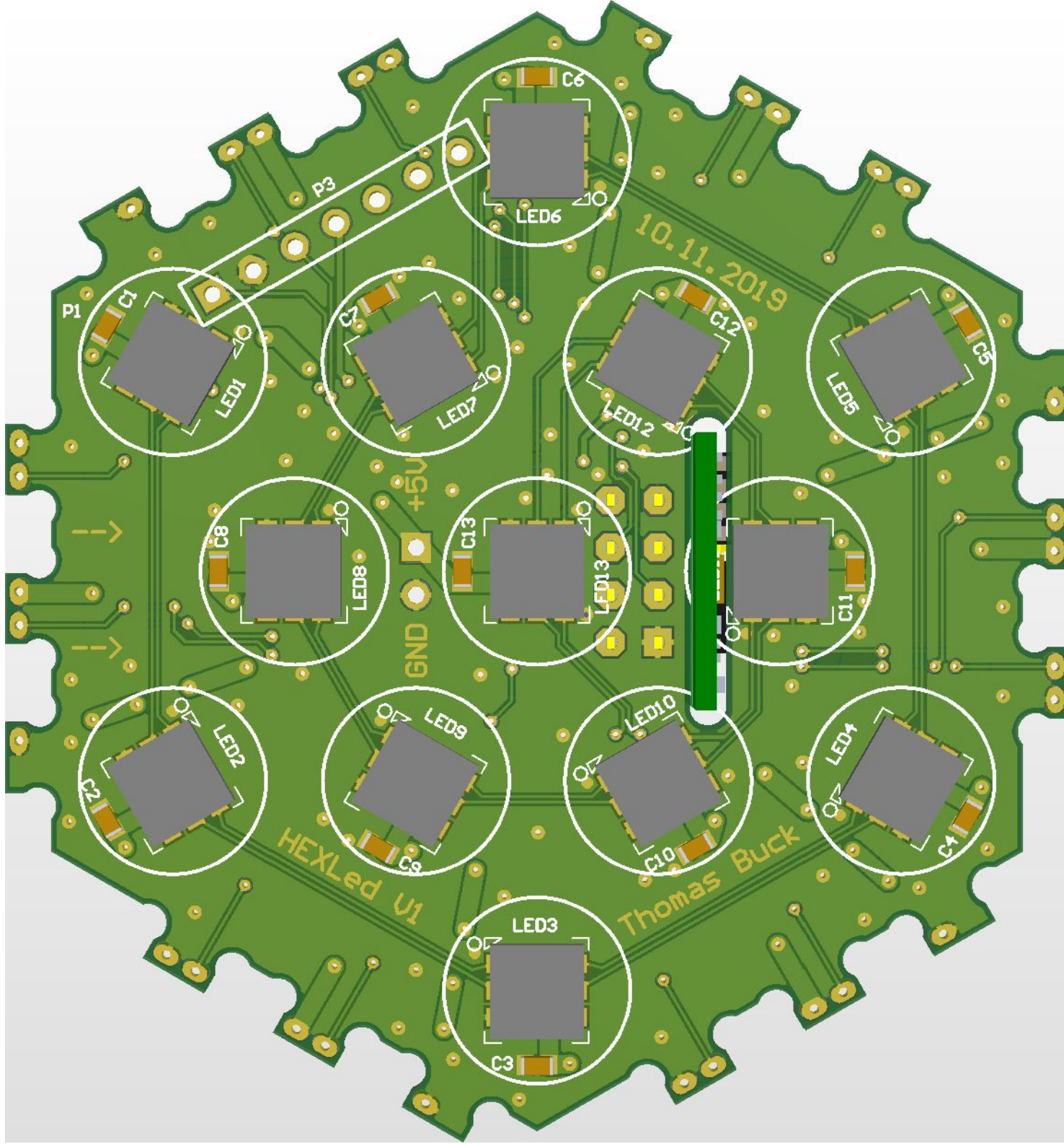

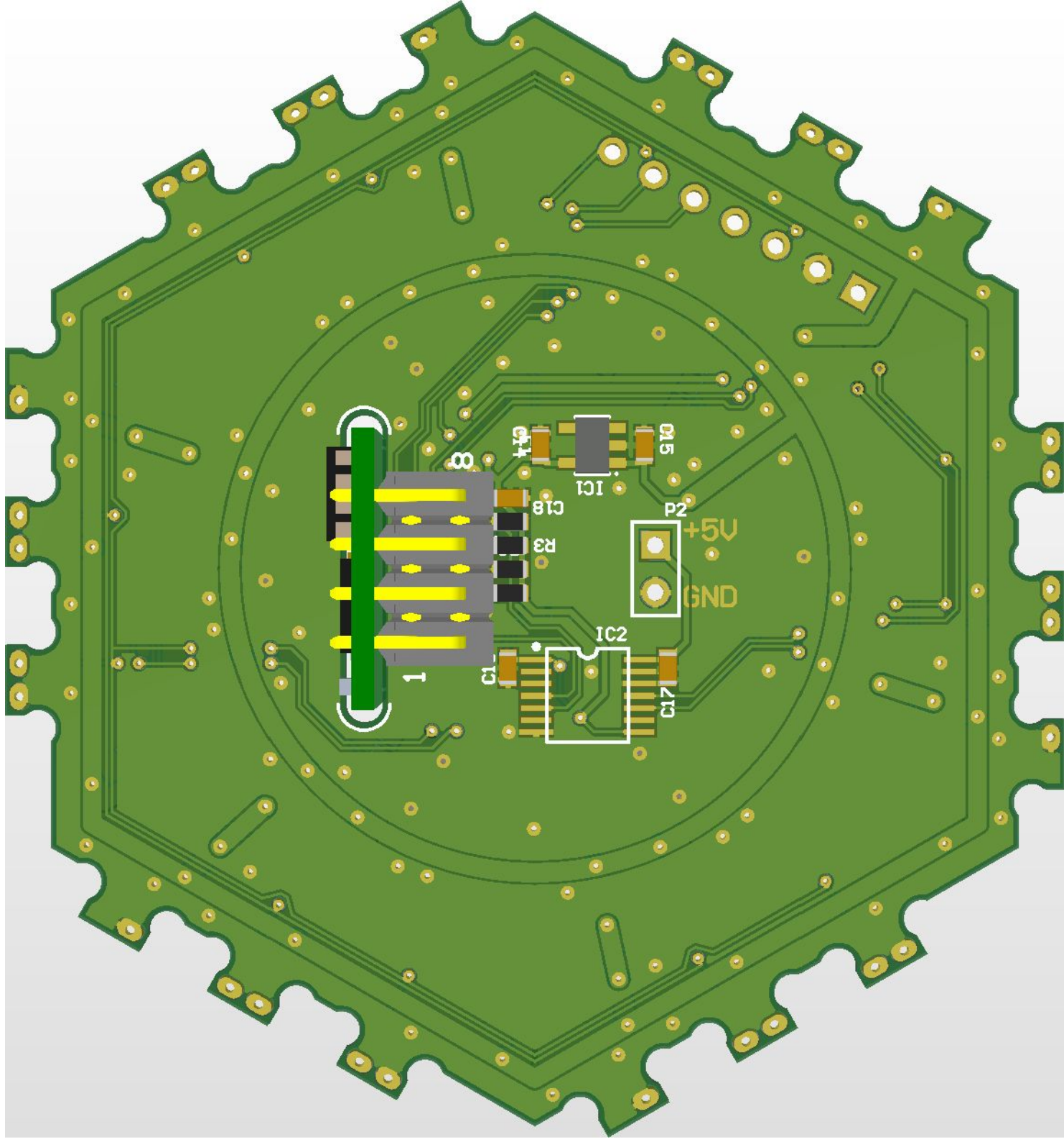

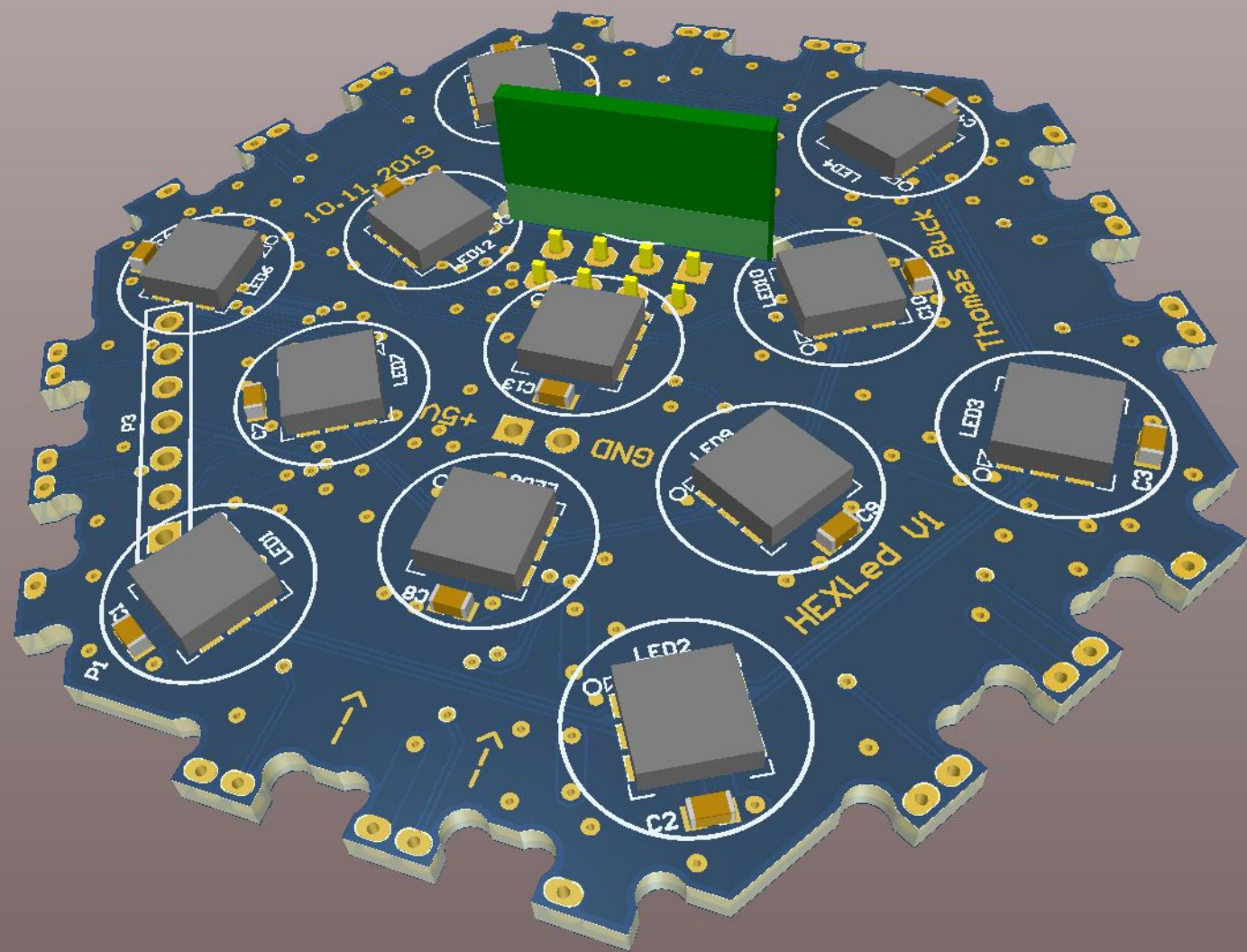

View from Back side (Scale 1:1)

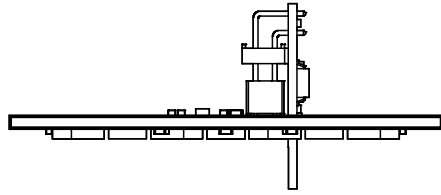

View from Left side (Scale 1:1)

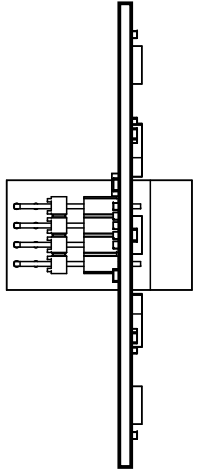

View from Top side (Scale 1:1)

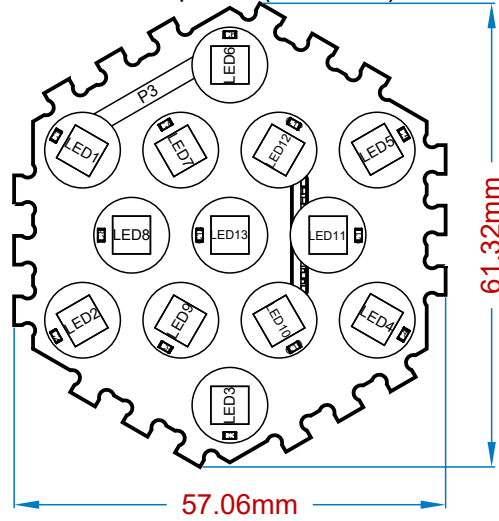

View from Right side (Scale 1:1) View from Bottom side (Scale 1:1)

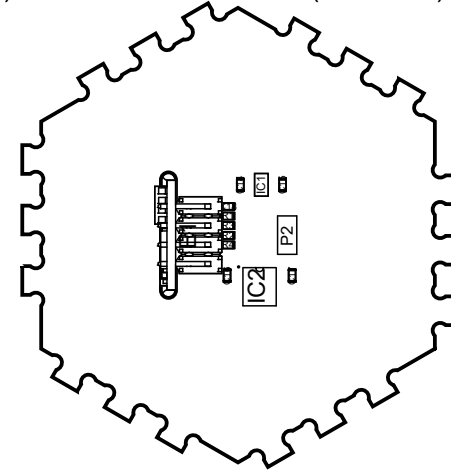
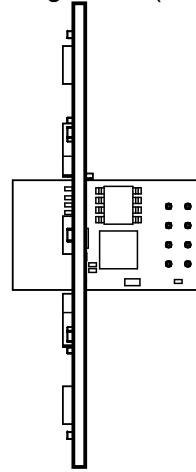

View from Front side (Scale 1:1)

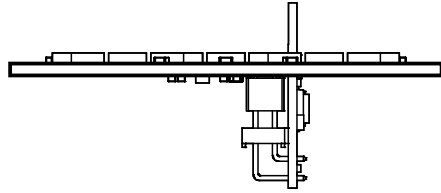

View from Front side (Scale 1:1)

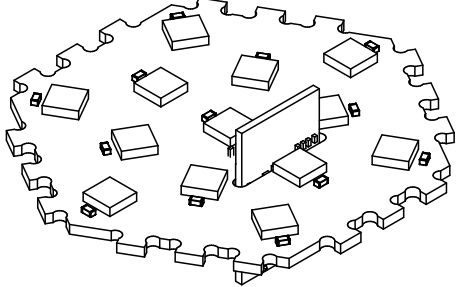

Drill Drawing View (Scale 1:1)

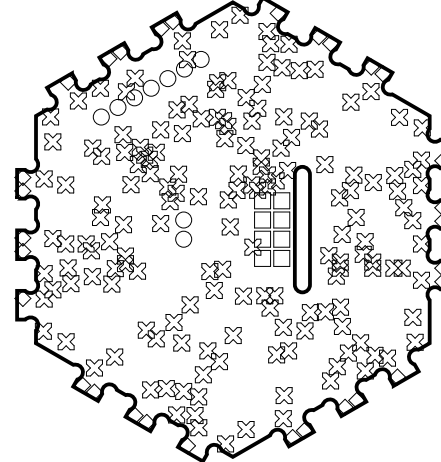

Drill Table

Symbol	Count	Hole Size	Plated	Hole Tolerance
⊗	168	0.30mm	Plated	None
◇	30	0.50mm	Plated	None
□	8	0.80mm	Plated	None
○	9	0.90mm	Plated	None
	215 Total			