

1 2 3 4 5 6 7 8 9

A

B

C

D

E

F

A

B

C

D

E

F

Boost

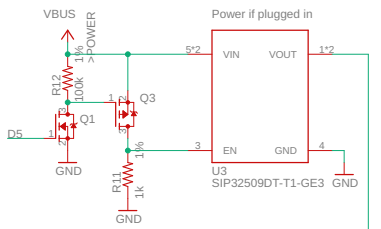

Headers

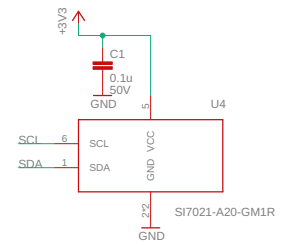
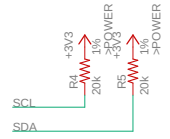
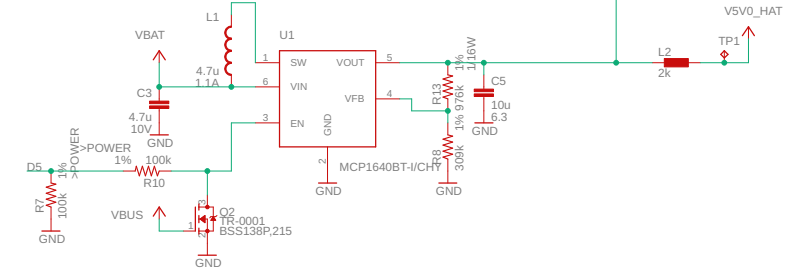
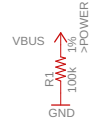
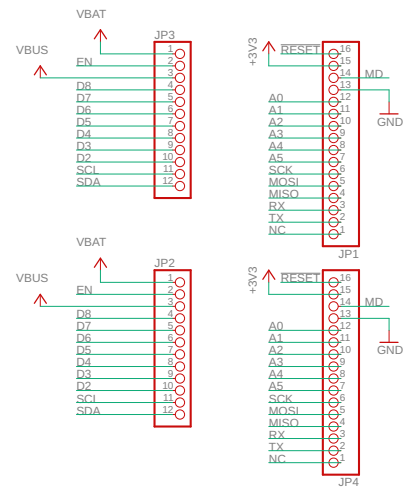

Si7021

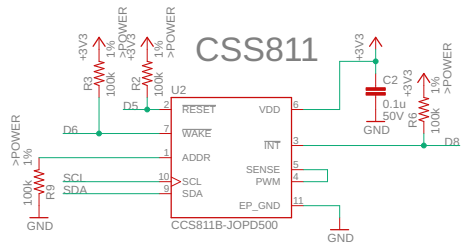

CSS811

HPMA115 Connection

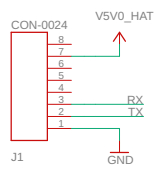

PCB1

Company: Circuit Dojo		Author: Jared Wolff	
Title: Particle^2 Sensor			
Document Number: SCH-0010			REV: 3
Board Number: BRD-0010			3
Date: 11/7/19 9:32 AM			Sheet: 1/1