

5min/条记录, 288条/天, 一条记录占用100B, 2MB可记录54天

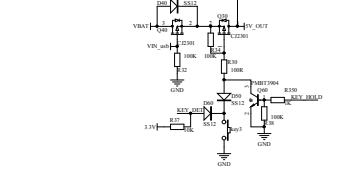

各电源模块开关控制

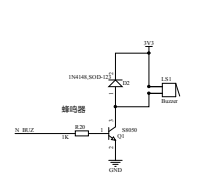
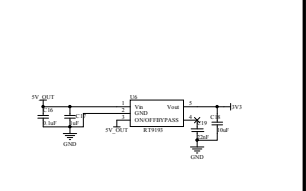
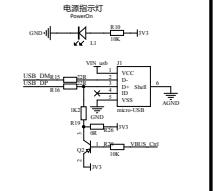
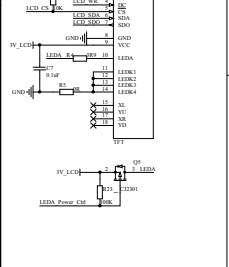
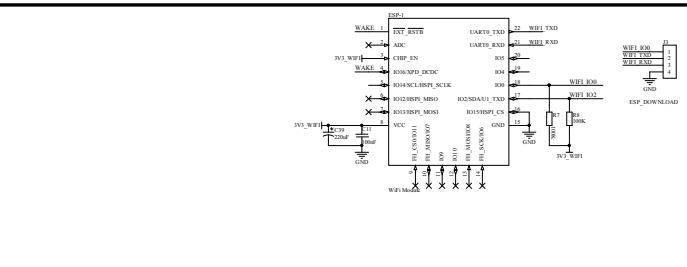
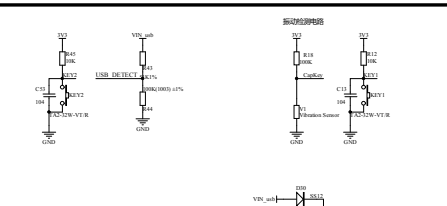
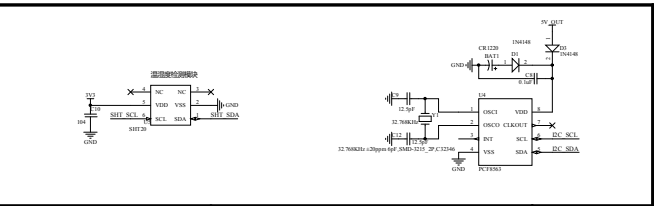
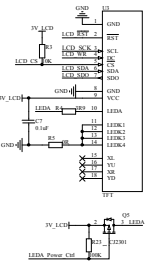
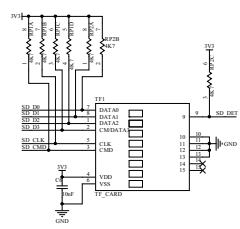
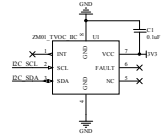
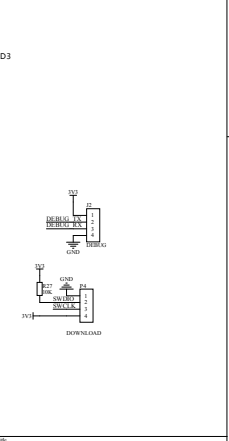
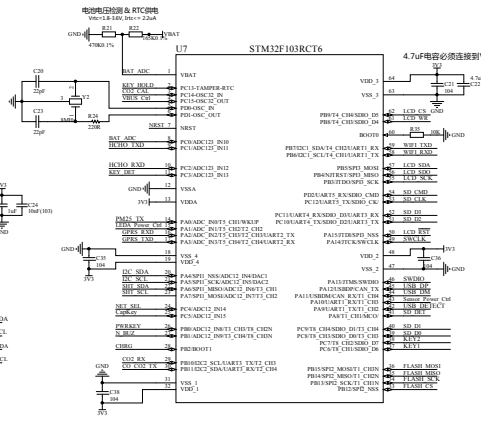
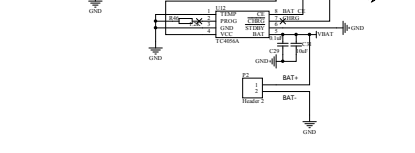
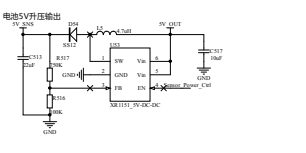
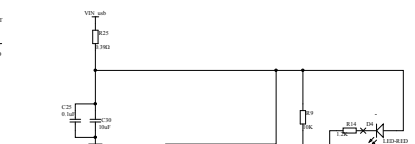
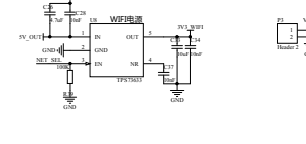
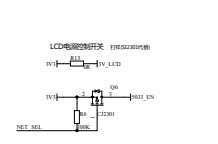

Item	Number	Quantity
A1		
PCB	100000	100000