

U_NFC
NFC.SchDoc

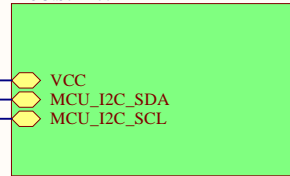

U_MCU
MCU.SchDoc



Title		
Module Diagram		
Size	Number	Revision
A4		A
Date:	2020-01-05	Sheet of
File:	C:\Users\...\Card.SchDoc	Drawn By: Michael Segev

Energy Harvest Filter

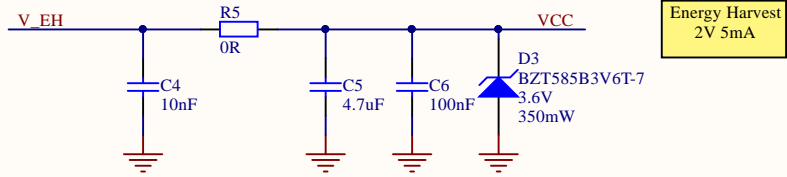

Ports



NFC

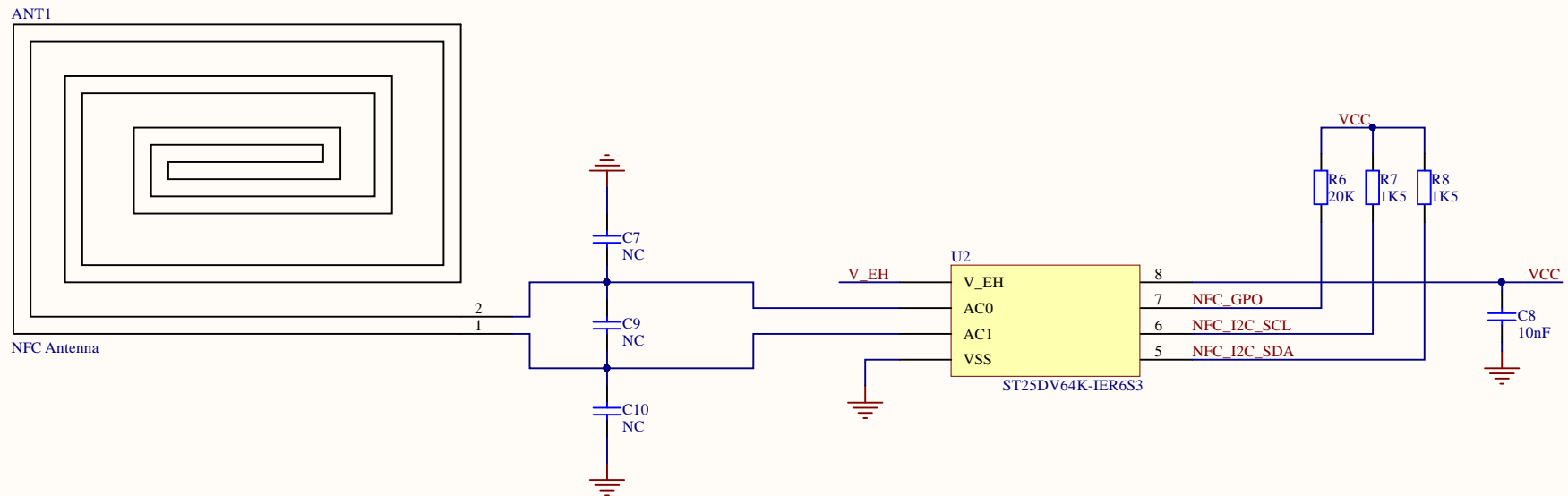

Title		NFC	
Size	Number	Revision	
A4	1	A	
Date:	2020-01-05	Sheet of	2
File:	C:\Users\...\NFC.SchDoc	Drawn By:	Michael Segev

MCU

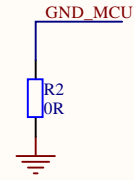
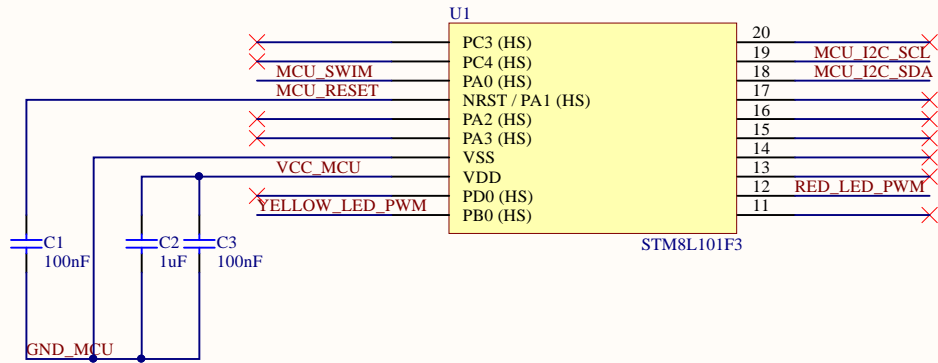

Ports

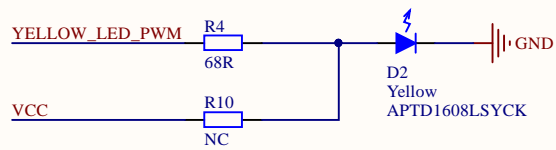
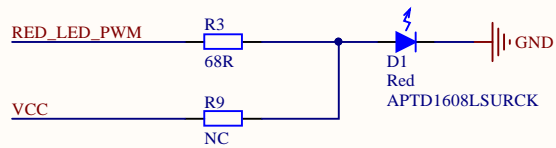
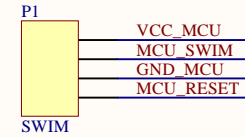
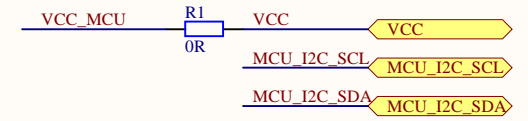

Title			MCU
Size	Number	Revision	
A4	2	A	
Date:	2020-01-05	Sheet of	2
File:	C:\Users\...\MCU.SchDoc	Drawn By:	Michael Segev