

# The Pandemic Ventilator

by [panvent](#) on December 24, 2007

## Table of Contents

The Pandemic Ventilator .....	1
Intro: The Pandemic Ventilator .....	2
Step 1: What It Looks Like .....	2
Step 2: Valves and Pipes .....	3
Step 3: Making The Bellows .....	4
Step 4: Adding The Bag .....	5
Step 5: PLC, Program, and Wiring .....	6
Step 6: Ventilator Running .....	7
Related Instructables .....	7
Comments .....	8

## Intro: The Pandemic Ventilator

Assembly instructions for a DIY Ventilator prototype.  
This could be useful in an Avian Flu pandemic.  
Constructed with commonly available components.

Many of us modify, hack, re-purpose, and DIY to save money, build something unique, create art, or show the world that there is a better way to use some device. And sometimes, just because it's cool. This is something different. It is a ventilator, and ventilators are meant to save lives. This project is called the Pandemic Ventilator, because it is meant to be used as a ventilator of last resort during a possible avian (bird) flu pandemic.

Many health authorities are preparing for the possibility of a flu pandemic in the next few years.

If a pandemic occurs that is related to the type of virus that is currently spreading in birds, they fear that it may be as bad or possibly worse than the 1918 Spanish flu pandemic. It is expected that the number of people that require treatment with ventilators may be much greater than the current number of ventilators in existence. If a pandemic were to strike, the hospitals could not just go out and buy all the ventilators they need, because there would not be enough parts or manufacturing capability. Many governments already have plans for triage and rationing programs that will determine who gets access to the limited number of ventilators and who will be left to die. When I first heard about this, I thought, "This is not good enough, if someone I know or love needs a ventilator, I would get one, I would build one myself if I had to". Thus the idea was born.

The earliest ventilators of the 1950s were primitive devices with even more primitive control and sensor systems, but they worked, and they saved many lives. Some of the early ones were built in workshops. This ventilator has a very primitive and basic design, but then it does benefit from a modern electronic control system. This is a basic ventilator design using materials that would still be readily available (or re-purposed) if a pandemic were to occur. It uses wood, tape, plastic bags, threaded pipe, solenoid valves, security system magnetic switches, and a PLC (Programmable Logic Controller). The prototype shown does not yet incorporate all of the proposed design features and the control program still needs some work to make it more stable and failsafe but it does function, as you can see from the video.

The Pandemic Ventilator Project is an open source hardware project. If you build your own development unit, please share your ideas, and experience at [www.panvent.blogspot.com](http://www.panvent.blogspot.com).

The information in this instructable is presented as *is* for development and investigative purposes only. The prototypes presented are not fully functional devices and have had no safety testing done. A ventilator is a potentially hazardous device and should only be operated by a trained and certified respiratory therapist. Any usage guidelines will be published for emergency use only, and only when a fully functional and validated unit has been completed. Anyone using this information to build or use a device agrees to waive any and all liability.

### The Pandemic Ventilator Project



#### Image Notes

1. Power supply in this box
2. These switches are connected to the sensors, so that the unit could be tested before it ran with air supply attached
3. The manometer pressure sensor will be attached here in the future.

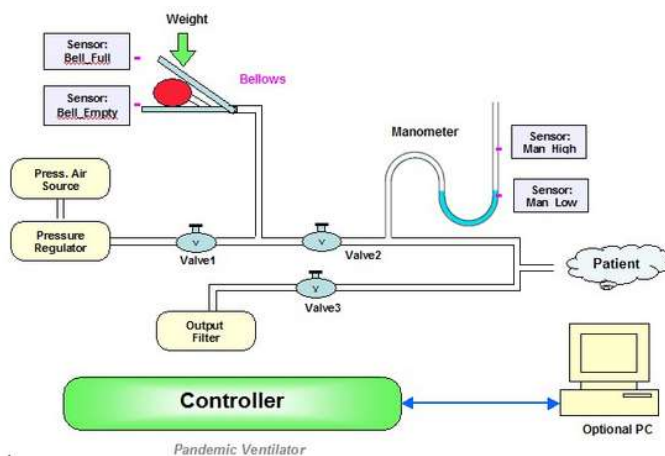

## Step 1: What It Looks Like

The Pandemic Ventilator Project

It basically consists of the bellows unit, which is made of wood, valves and piping, a PLC controller, some wires and switches and a power supply unit. The whole unit is mounted on a piece of 1/2 inch thick plywood that is 18 inches by 21 inches.

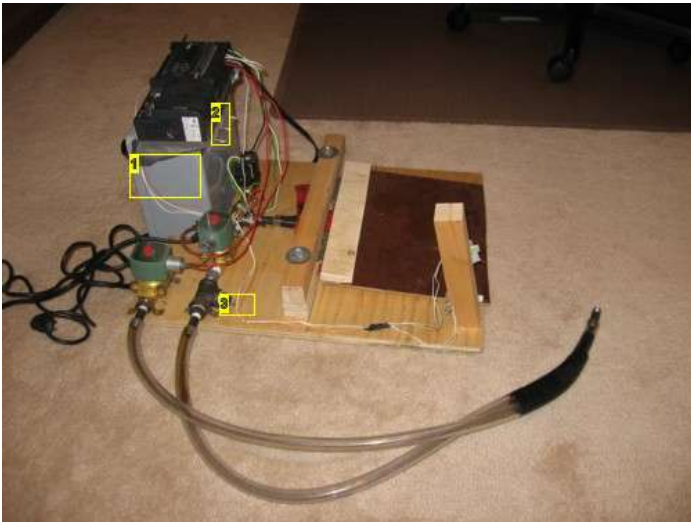

**Image Notes**

1. Power supply in this box
2. These switches are connected to the sensors, so that the unit could be tested before it ran with air supply attached
3. The manometer pressure sensor will be attached here in the future.

**Step 2: Valves and Pipes**

The Pandemic Ventilator Project

To get started you will need the valves. You may be able to find some used ones somewhere. New valves are expensive, over \$100 each. The inlet valve can be 1/4 inch normally open valve, the other two should be a minimum 1/2 inch diameter, one normally open (NO) and the other normally closed (NC). They must be of a direct acting solenoid type.

Direct acting solenoid types are required to operate with air. Pilot operated types will only operate with liquids. Pressure ratings do not matter for the 1/2 inch valves, but the 1/4 inch valve should have at least a 50 psi rating. If you can only get either NO or NC 1/2 inch valves you can still make it work by adjusting the PLC program. The inlet 1/4inch valve must be a NC valve or you will end up blowing up a lot of bags in the testing phase.

The valves are connected with pipe and mounted in such a way that the T to the Bellows lines up with the center of the bellows unit.

I used threaded pipe fittings. with teflon tape on the fittings.

I also used:

- Two 1/2 inch NPT Ts, One 1/4 inch airline fitting (to connect to an air supply)
- Four 1/4 inch pipe nipples (short pipe sections threaded at both ends)
- Three 1/4 inch to 1/2 inch adapters
- Two 1/2 inch pipe nipples
- One 1/2 inch plug (this plugs the line that will go to the manometer planned for later)

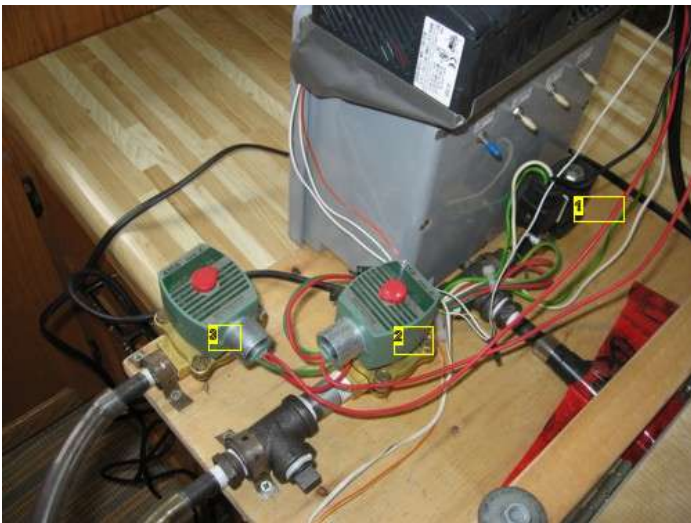

**Image Notes**

1. Valve 1 (fills bellows)
2. Valve 2 (controls air flow to patient)
3. Valve 3 (controls air flow from patient)



**Image Notes**

1. 1/2 inch to 1/4 inch bushing with 1/4 inch nipple allows patient tubing line to be attached

### Step 3: Making The Bellows

The Pandemic Ventilator Project

The bellows unit has a hinged section of quarter inch plywood that is 10 1/2 inches by 12 1/2 inches.

There is a one and a 1/2 and a 1/2 inch by 9 inch sensor pole attached beside the bellows that is used to position the magnetic switches. These are magnetically activated reed switches that are usually used for security systems. The sensor pole should be angled at the bottom so that the top leans back about 1 1/2 inches from the bottom.

The bellows hinge is constructed of 4 pieces of 1 1/2 by 7 inch 5/8 inch plywood pieces and a 1 1/2 by 1 1/2 inch by 17 inch piece of wood, two 3 inch hinges and a 2 inch by 12 1/2 reinforcement.

The bellows is made by screwing down the bottom 2 plywood pieces to the backing board.

Arrange the other 2 plywood pieces directly over the first two, cover with the 17 inch piece of wood and and clamp together.

Drill holes centered 2 and 3/4 inches from each end to accept 1/4 inch carriage bolts inserted from the bottom.  
Un-clamp and remove the top 17 inch piece of wood.

Insert carriage bolts from the bottom to line up the middle layer plywood pieces and clamp again.

Screw hinges to middle layer plywood. Ensure the screws do not protrude through the plywood to the bottom layer.

Screw the other side of the hinges to the bellows lid between the lid and the reinforcing strip.

The bag is clamped between the two plywood sections during operation using the nuts and washers on the carriage bolts.

The magnet is attached to the end of the bellows near the sensor pole, and the sensors are attached to the sensor pole. I just used duct tape to attach them so that they can be easily adjusted during the testing phase.

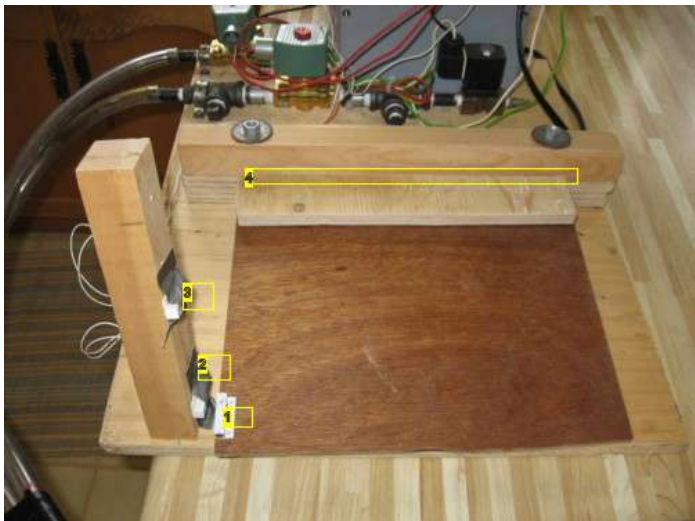

#### Image Notes

1. Magnet
2. Lower sensor switch
3. Upper sensor switch
4. Hinged here

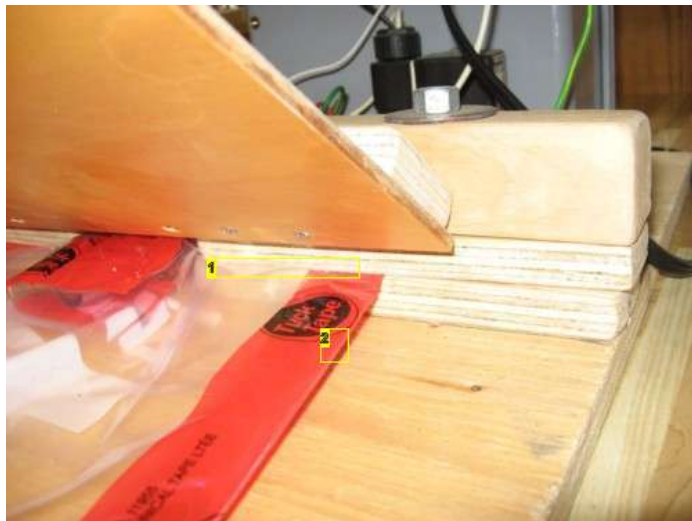

#### Image Notes

1. The bag is clamped between the pieces of wood to seal the end
2. Tuck Tape along the edges of the bag reinforce it and prevent leaks

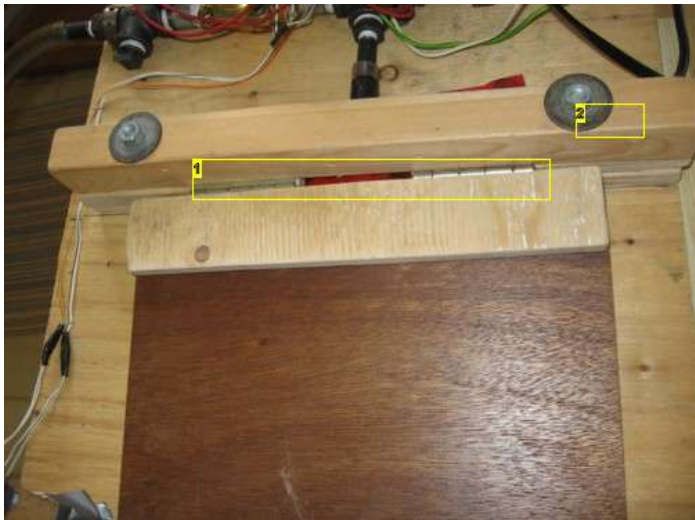

#### Image Notes

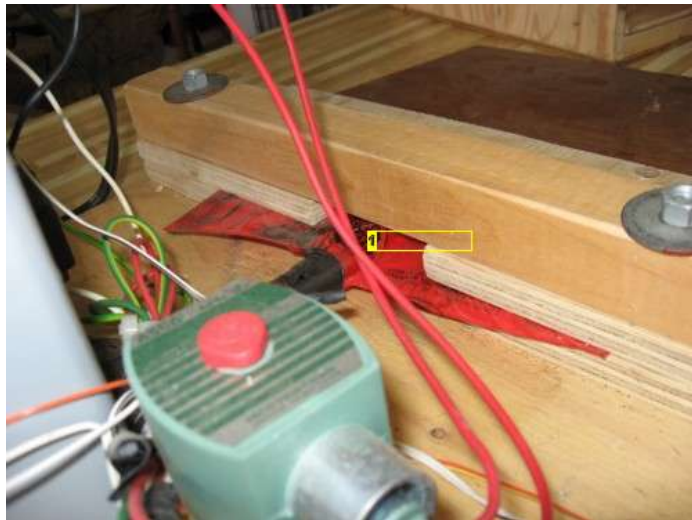

#### Image Notes

1. 2 door hinges
2. Bolts up from bottom clamp down the top rail to hold the bag in place.

1. A short piece of tubing is taped in the center of the bag and then taped to the pipe

### Step 4: Adding The Bag

The Pandemic Ventilator Project

To make the bag for the bellows, I used a large size Ziplock freezer bag.

Cut off the ziplock part.

Inert 1/2 inch plastic tubing into the center and use Tuck tape to seal and reinforce the edges.

The tubing should stick out of the bag far enough to be able to be slipped over the end of the 1/4 inch nipple section of piping.

The taped seam of the bellows bag should be in on the bottom plywood section.

Install the hinged cover and then the top 17 inch section.

Clamp together with the 4inch long 1/4 inch carriage bolts, two nuts and 2 washers.

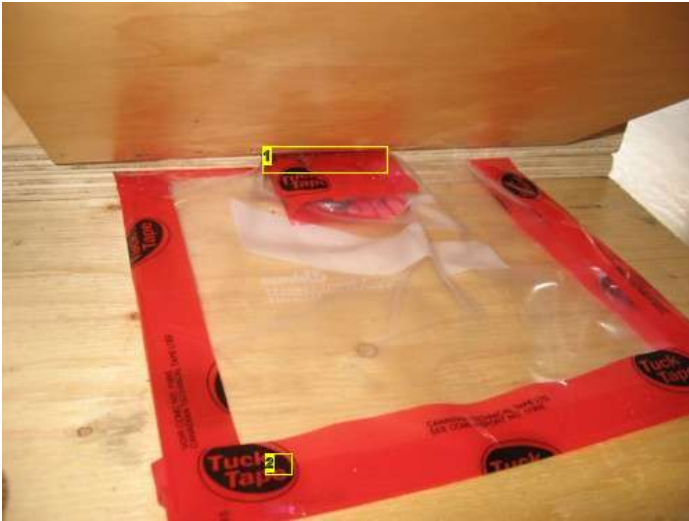

#### Image Notes

1. There is a gap here where the tubing to fill the bag can go through
2. That Tuck tape really sticks well to plastic bags. It is meant for sealing vapor barriers and such in construction. You can get it or an equivalent tape at a building supply store.

#### Image Notes

1. You have to use the freezer bags rather than the general purpose ones. The freezer bags are much thicker and should last longer.

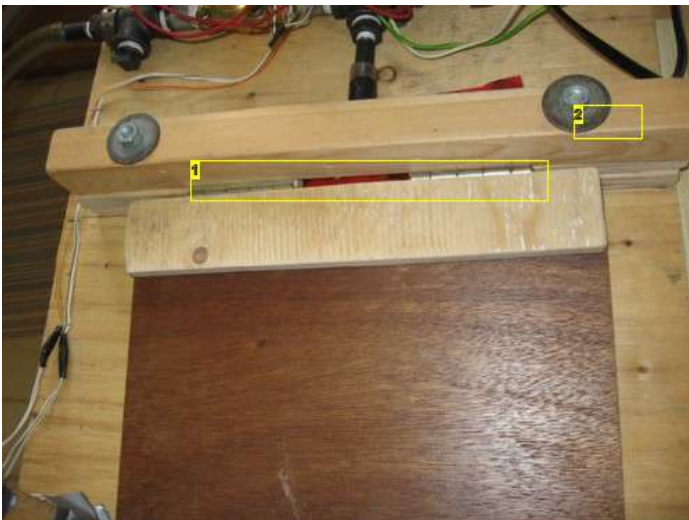

#### Image Notes

1. 2 door hinges
2. Bolts up from bottom clamp down the top rail to hold the bag in place.

## Step 5: PLC, Program, and Wiring

The Pandemic Ventilator Project

The PLC unit is a Direct Logic 06 DO-06DR from Automation Direct. Automation Direct  
Their units are low cost, flexible enough and they have a lot of free software to program with.

You could use other PLC units and write your own control program. If you do, please share your work at The Pandemic Ventilator Project so that others can use your program and insights as well.

Besides the PLC you will also need a 24V power supply, and an on off switch to start the system.

### Program

Also below is the ladder logic program that runs the unit. (My son does the programming) As I said it is still very rudimentary. It will require some improvement to make it more stable. The program will also have to be extended to accept the inputs from the future manometer, and also incorporate safety systems and alarms.

Basically what it does is:

It opens valve 1 and closes valve 2 until the bellows is full which is indicated when the top magnetic switch closes.

It then closes valve 1, opens valve 2 and closes valve 3 so that the bellows can deflate and pump the air to the patient.

When the bellows drops to the lower limit, the lower magnetic switch closes and then valve 2 closes and valve 1 opens again to refill the bellows.

A timer lets the patients lungs deflate with valve 3 open. When the timer expires, valve 2 opens and valve 3 closes to start the next respiration cycle.

In the future I hope to get the manometer to be able to control the respiration cycles as well as the timer.

### Wiring

Everything is wired back to the PLC connectors and power supplies..

My unit has all NC valves so the program should be slightly different if you use a NO valve for valve 3 as I recommended. Also I used all 120V valves. If you use 24V valves, then the output CO will be connected to 24V instead of 120V and the output returns would be connected to the 24V ground. Here is the wiring chart.

#### INPUTS

X0 Top bellows mag switch  
X1 Bottom bellows mag switch  
X2 on off switch  
C0 24V  
All returns to Ground

#### Outputs

Y0 Unused  
Y1 Inhale valve (V2)  
Y2 Exhale valve (V3)  
Y3 Bellows fill valve (V1)  
C0 120VAC line  
All returns to line Neutral

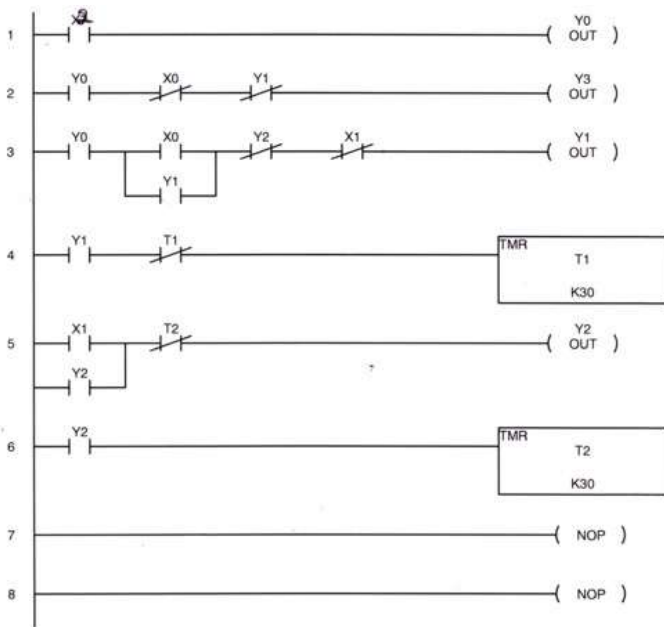

#### Image Notes

1. This is the output or control side where the valves connect to.
2. The sensors connect here

## Step 6: Ventilator Running

The Pandemic Ventilator Project

Here is a video of the Pandemic Ventilator running.



I am using an earlier bellows design for my patient simulator. If you wish to test run your own unit you can build a second bellows unit for a lung simulator. No not try it on yourself or anyone else. The patient airline that runs to the simulator is 1/2 inch ID plastic tubing that has been Y ed together at the patient end. You need a regulated compressed air source to run it. It is best if you can get the pressure down to about 10 psi. The higher the inlet pressure, the greater the chance that the bellows will inflate too fast for the upper level switch to detect. If this happens, you blow up your bellows bag. When I initially test ran my unit, I used switches to simulate the bellows mag switches to confirm that the program would function as intended.

I put some wrenches for weights on the bellows and simulator. The weight on the bellows provides the pressure to inflate the patients lungs. The weight on the patient simulator bellows simulated the lung expelling the air. The bellows weight has to be greater than the simulator weight to make it work.

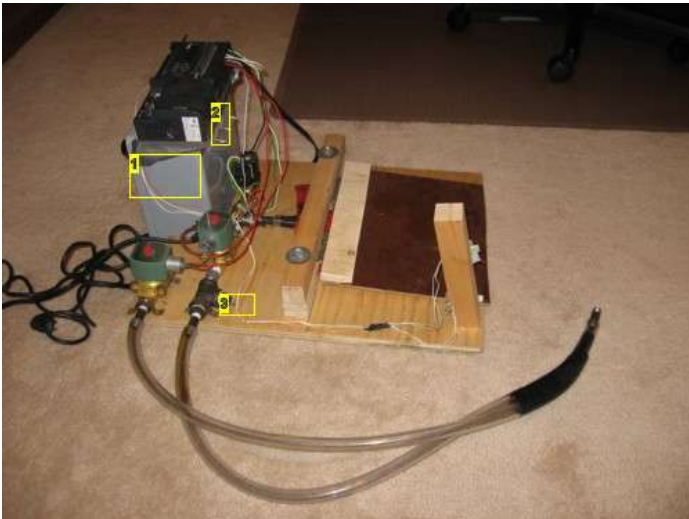

### Image Notes

1. Power supply in this box
2. These switches are connected to the sensors, so that the unit could be tested before it ran with air supply attached
3. The manometer pressure sensor will be attached here in the future.

## Related Instructables



Thanks for watching!  
Rate, Comment, Subscribe!  
**Episode 8: The Portable Face Mask Dispenser** (video) by StupidInventions



**make ppc better than ipod** by goldbar2975



**Nikon Coolpix L15 battery door fix** (Photos) by lendif



**Knex Music Stand** by knexman2001



**TUBE SCREAMER FX PEDAL** by underground



**dash led mod** by slideways

## Comments

14 comments [Add Comment](#)



**agussutopo** says:  
I cannot see the video. Please inform that another one have same problem?

Sep 29, 2010. 12:16 AM [REPLY](#)



**dombeef** says:  
Swine flu? lol

May 1, 2009. 6:18 PM [REPLY](#)



**gormly** says:  
>>"Most authorities believe that a flu pandemic will strike the world within the next few years. " No offense meant but I do not believe Instructables is here to spread falsehoods or to scare people. "Most" implies the majority and the majority would include the US, UK and other World Health Organizations. Since none have officially come out and said they "believe that a flu pandemic will strike the world within the next few years" then by definition you are spreading unproven and unfounded falsehoods. In my eyes, thats not cool. Not here anyway. You can go somewhere else to spread that.. say like the ATS forums. FYI: The amount of people who died last year from falls from a 3 foot ladder far outweigh the number dead from any "bird" flu. I like your instructable, it's creative, but its premise is .. seriously flawed.

Dec 27, 2007. 5:27 PM [REPLY](#)



**tornadoboy** says:  
April 27 2009 Care to repeat that statement for everyone?

Apr 28, 2009. 6:07 AM [REPLY](#)



**gormly** says:  
My comment is 2 years old in case you didn't notice. Nice trolling.... I stand by my original statement AT THE TIME and ON THE SUBJECT at hand. Hindsight is a wonderful thing, and even right now 04/30/09 by no means are we anywhere near the point of the need for homemade ventilators. if you build this and stake your life on it in case of any infection, your chances go DOWN rather than UP. So.. tornadoboy.. tell me, what was wrong with what I said back in 2007?

Apr 30, 2009. 4:06 PM [REPLY](#)



**xACIDITYx** says:  
xD

Apr 30, 2009. 11:50 AM [REPLY](#)



**panvent** says:  
You are right in your criticism of my statement. Pandemics are in fact extremely difficult to predict ahead of time as to timing and severity. I changed the statement to: "Many health authorities are preparing for the possibility of a flu pandemic in the next few years." I also softened the statement following that line. This, I believe is more accurate and reflects the actions and policies such as the World health Organization. WHO|[http://www.who.int/csr/disease/avian\\_influenza/phase/en/index.html](http://www.who.int/csr/disease/avian_influenza/phase/en/index.html)

Dec 28, 2007. 6:44 AM [REPLY](#)

WHO states on their website, "Experts at WHO and elsewhere believe that the world is now closer to another influenza pandemic than at any time since 1968, when the last of the previous century's three pandemics occurred." They also state, "The world is presently in phase 3: a new influenza virus subtype is causing disease in humans, but is not yet spreading efficiently and sustainably among humans."

The US Department of Health and Human Services is a little more restrained in their statements on their website. [PandemicFlu.gov](http://PandemicFlu.gov)

It is important to remember that the risk right now is fairly low, and may in fact stay low for a long period of time, but the best time to prepare for potential problems is before they happen.



**panvent** says:  
The link to WHO did not seem to attach properly. Here it is again. WHO

Dec 28, 2007. 6:53 AM [REPLY](#)



**nate121** says:  
go to ohio-pandemicflu.gov its the only one i could find about the flu and it will happen again 20??

Aug 30, 2008. 7:49 AM [REPLY](#)



**dan** says:  
this is interesting, can you explain more about how it works / how it is used, you've covered how to make it well. what i was able to figure out is it seems like this is for use by an already sick patient, not for pro-active use? and it will feed the patient clean air and filter their exhale? then working through the component diagram i'm a bit confused about the timing of the air flows through the different valves, and also what is the purpose of the bellows? i've used scuba gear, it does not use bellows - although it is also not the most comfortable thing since it requires a little bit of inhale force. also how do you hydrate the inhaled air?

Dec 25, 2007. 1:30 AM [REPLY](#)



**panvent** says:  
This is a basic prototype to show that a ventilator could be constructed from basic readily available components during a flu pandemic after all of the existing ventilators are being used. A lot of commercial ventilators use air valves and regulators to control the airflow, and this works very well, but these are highly engineered devices that would probably not be available in high enough quantities during a pandemic. The bellows is used instead to control the rate, volume and pressure of air delivered to the patient. The rate can be controlled by the cycle time, the volume by adjusting the fill and empty set points and the pressure by adjusting the weight on the bellows. The bellows design is also more efficient in it's use of air, in that no air is wasted for control purposes. It would still require trained persons to operate it, so it would have to be used in a hospital. The hospital would have filtered air

Dec 25, 2007. 6:25 AM [REPLY](#)



available and they could use an existing unit to add moisture to the inhaled air. Another feature that is still required is a method to add more oxygen to the air. This will need another valve on the intake side.

---



**jimmyb0nz** says:

I like it! Hope I never have to build one.....

Dec 24, 2007. 7:21 PM [REPLY](#)

---



**Weissensteinburg** says:

Way to think ahead! I just hope you never get to use is =[

Dec 24, 2007. 4:53 PM [REPLY](#)

---



**GorillazMiko** says:

awesome, looks like you put a lot of work/ thought into this great instructable.

Dec 24, 2007. 4:29 PM [REPLY](#)

---