

1

2

3

4

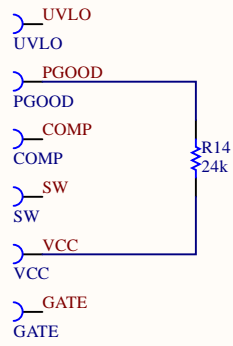
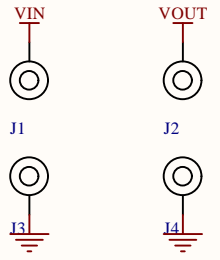

1

2

3

4

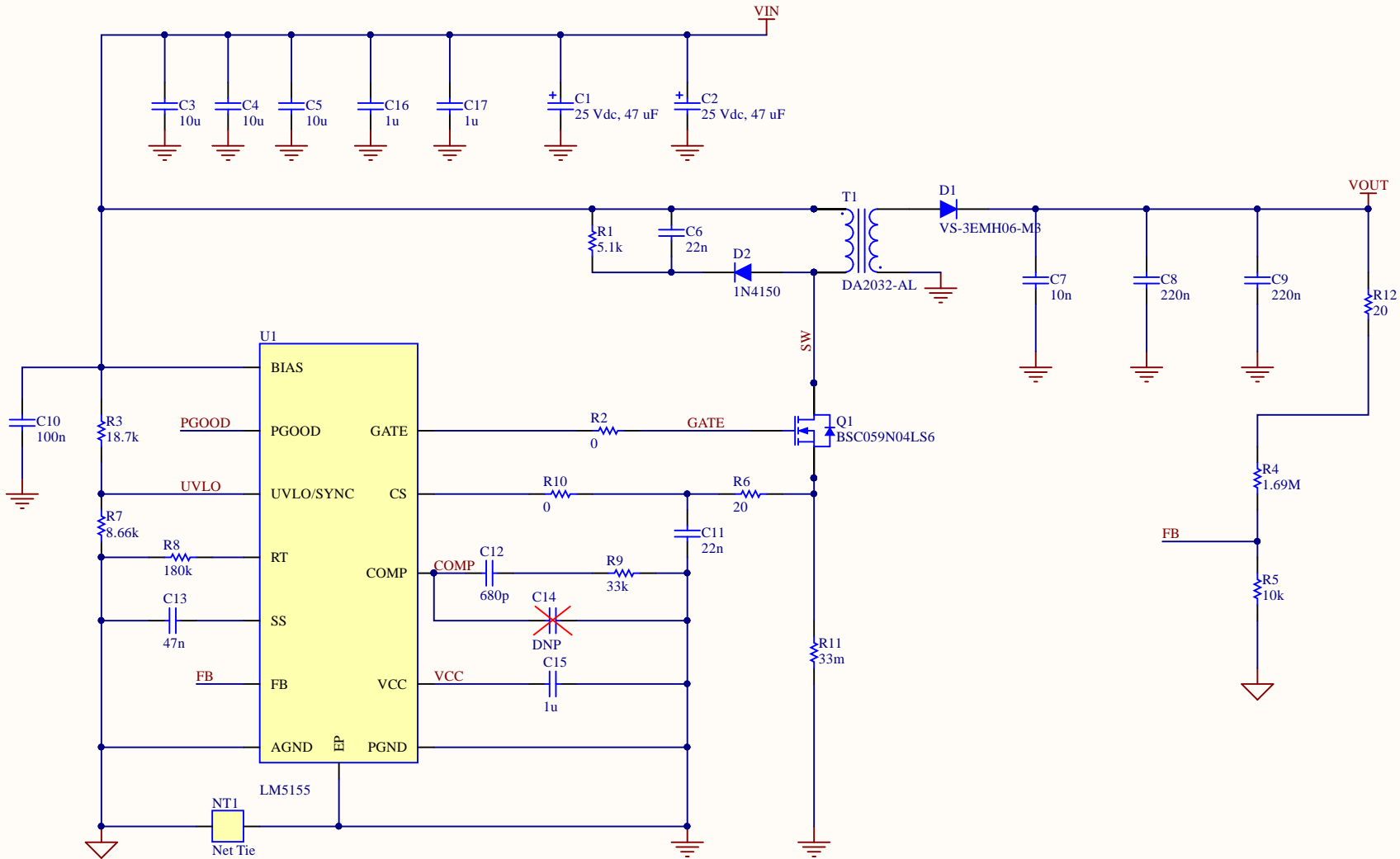

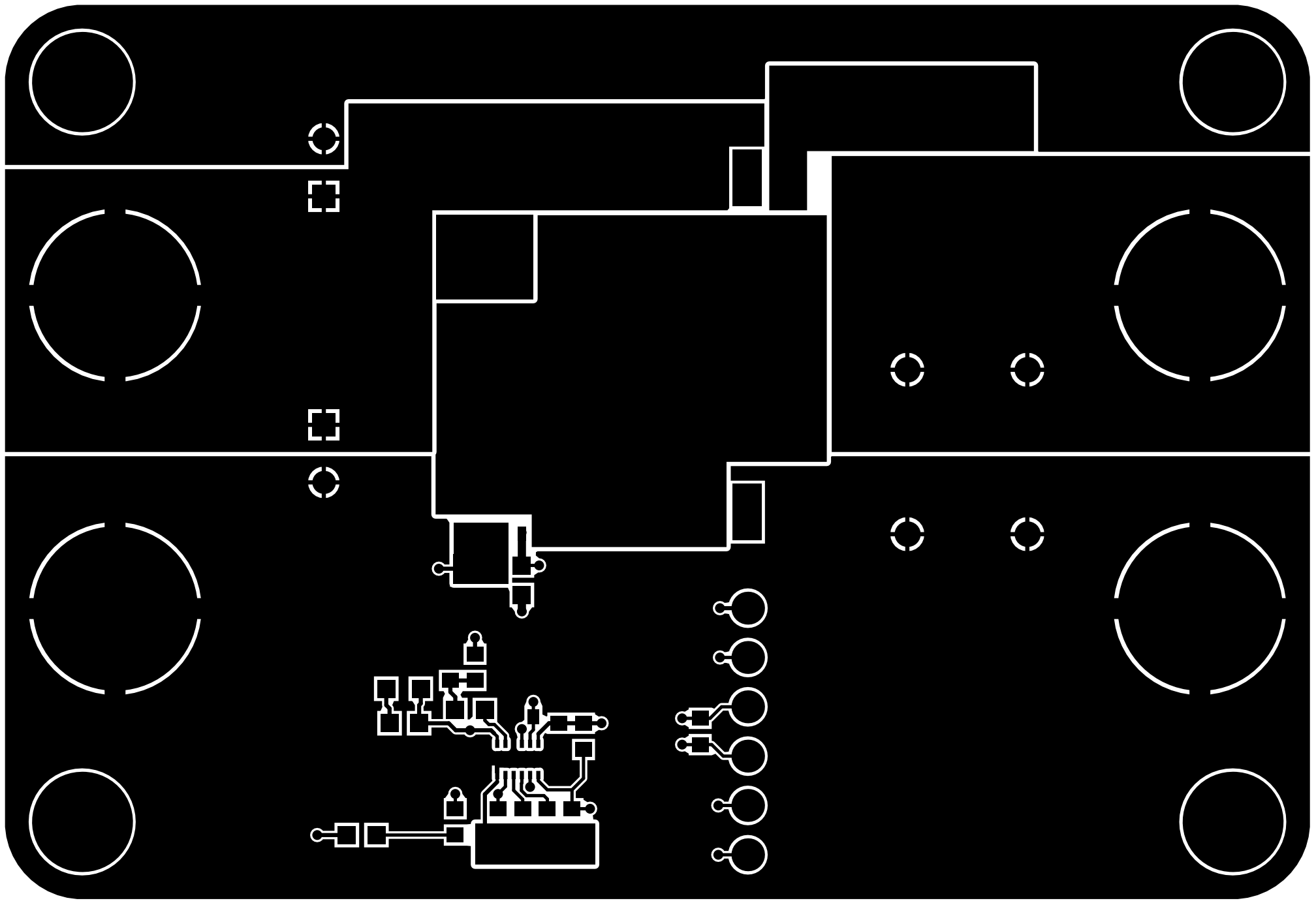

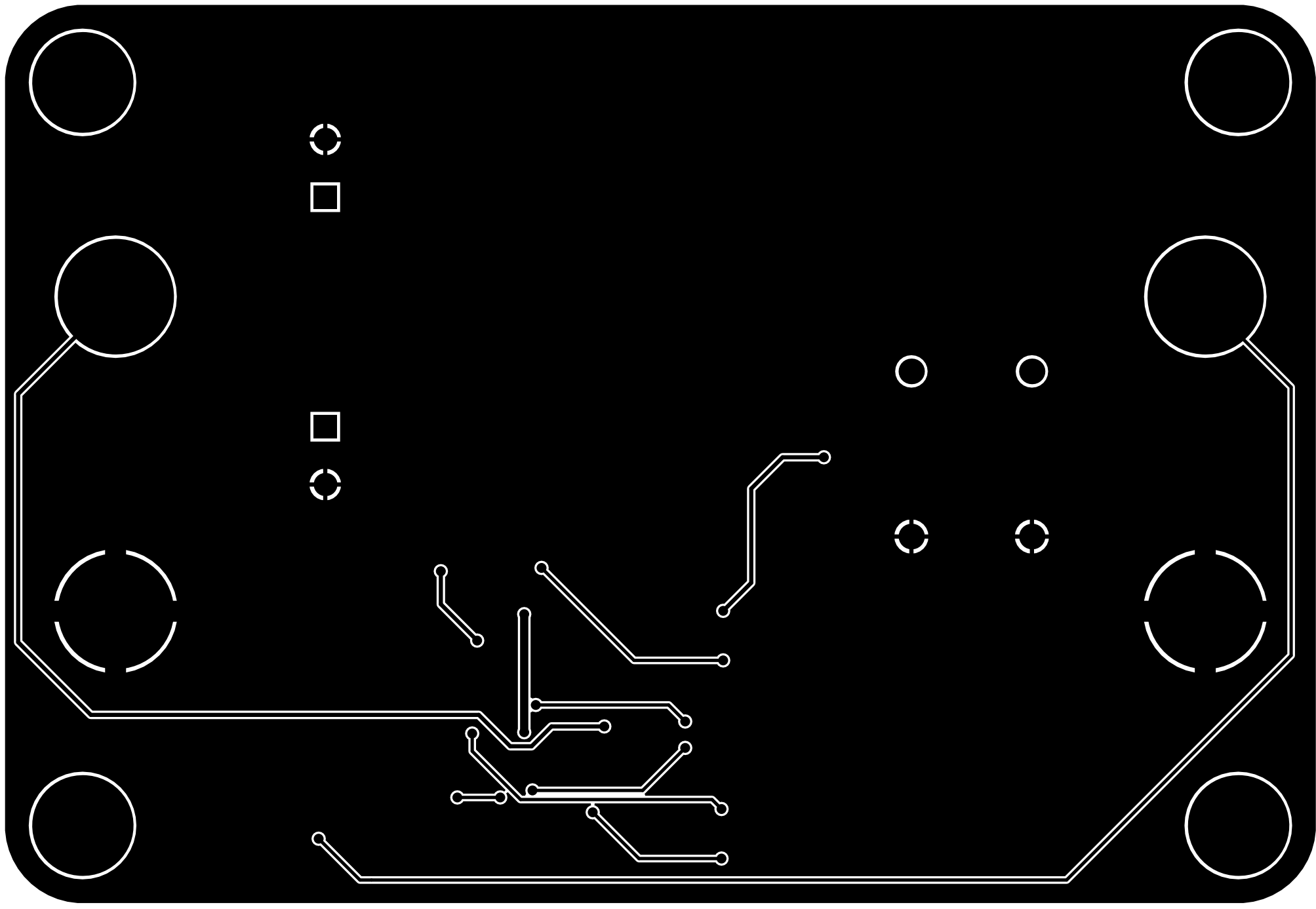



CAUTION: C3C4C5  
HOT SURFACE

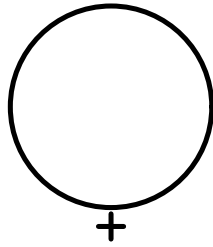

C2

R1

C6

D2

T1

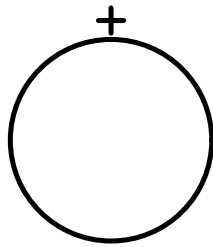

C1

Q1

R11

R2

C12  
C14  
C15

R12

R4  
R10

R5  
C13

C11  
R6  
C15  
U1  
R8  
R7  
R3  
R14

C16  
C17

D1

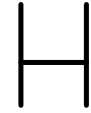

WARNING:  
HIGH  
VOLTAGE



C8

C9

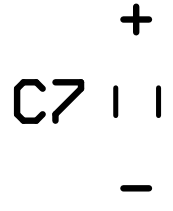

C7

170 VDC

+  
5-12 VDC  
-

SW  
GATE  
VCC  
PGOOD  
COMP  
UVLO

Rev. B

NOTES:

