

Video buffer

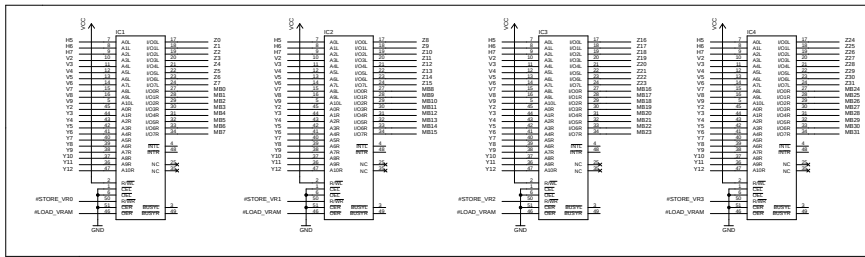

Special Registers selection

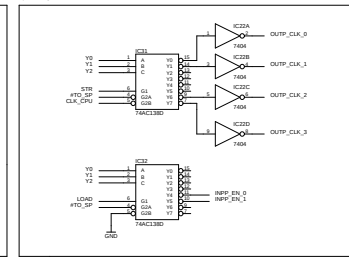

Horizontal counter

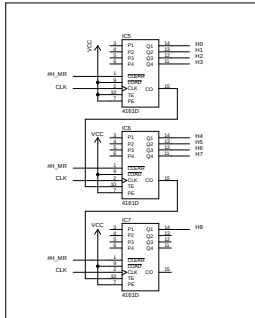

Vertical counter

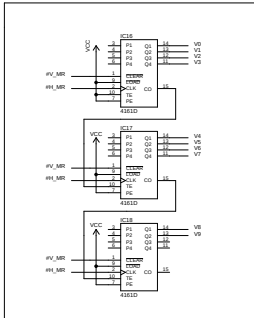

Color decoder

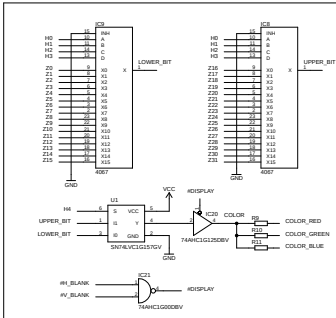

Output registers

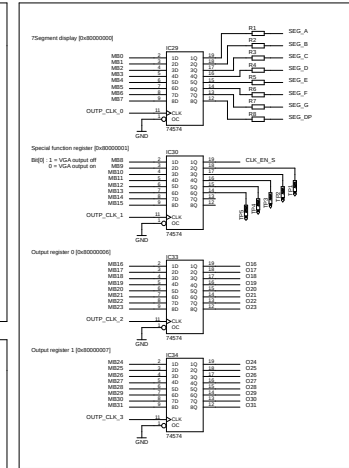

Horizontal logic

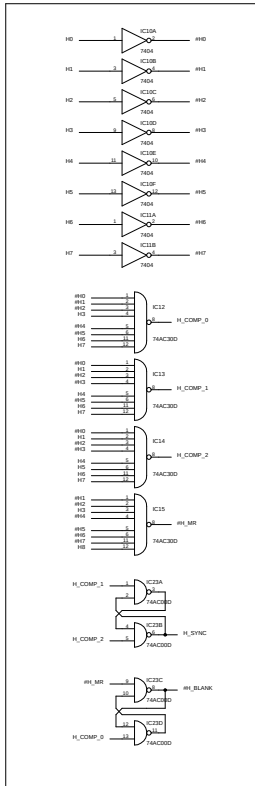

Vertical logic

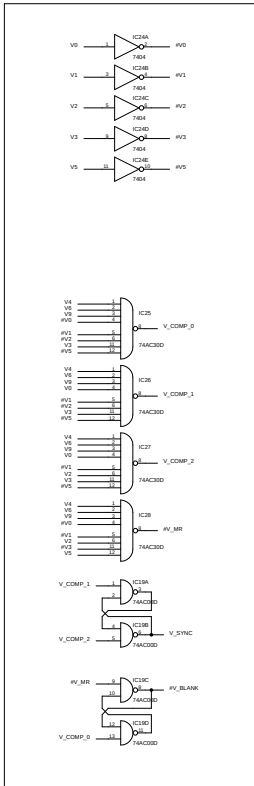

10MHz generator

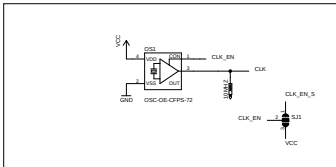

Connectors

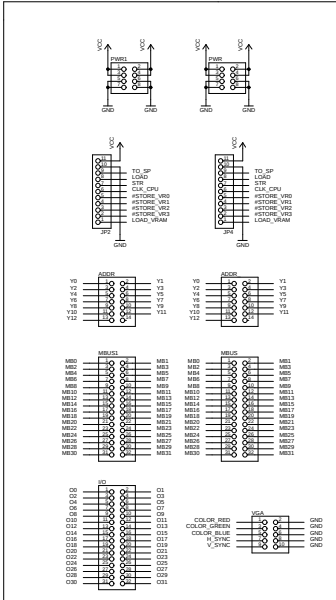

Input circuit

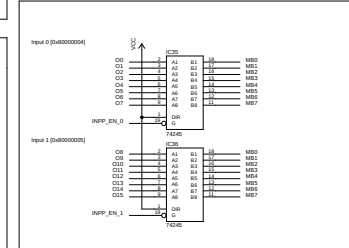

Test points

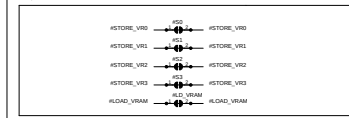

7 segment display

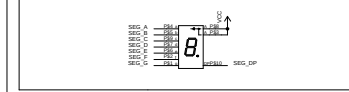

Power

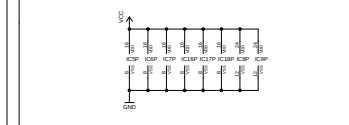

Decoupling capacitors

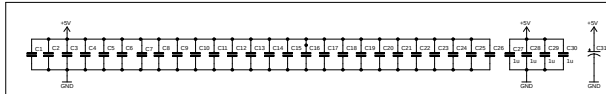

Inverters

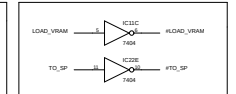

Unwanted gates

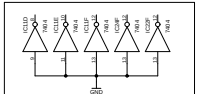

VGA CARD  
29/10/2020