

robotistan

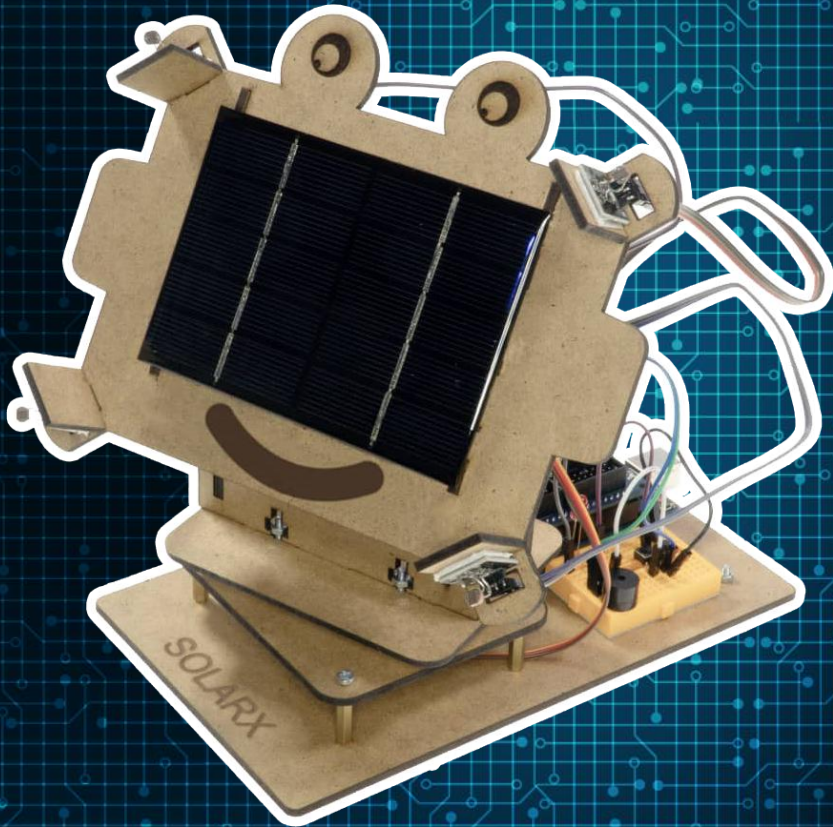

Robotistan Solar Tracking Kit with Arduino



Why Solar Panel?

Solar panels are inexpensive and easily accessible everywhere. In addition, advanced electrical knowledge is not required to make a solar panel system, because there are frequent descriptions on Youtube or DIY sites.

You have probably seen solar panels on the roofs of some houses. Solar panels, which were not very common in the past, started to become very popular thanks to the government subsidy. Installing a solar panel system in a home or building is quite logical as it requires very little maintenance and repairs.

The project is basically based on the movement of sunlight according to the angle of incidence. For this purpose, it is aimed to benefit from sunlight with maximum efficiency throughout the day.

Thanks to the 2 Servo Motors in your project, the axes will be able to move according to the sun angles.

If you've installed solar panels to support your electricity needs, on a camping trip or in a caravan to provide electricity, with this project you can be sure the panels are properly aligned. The project has a number of different mechanisms that work on a series of principles to align your panel directly to the sun.

There are two basic types of trackers: single and dual axis trackers. Single-axis trackers are adjusted every month so that seasonal changes in sun position are taken into account, then the single axis is used to track the daily movement of the sun across the sky. Dual axis trackers eliminate the need for monthly adjustments by using one axis to track the daily movement of the suns and another axis to track seasonal movement. The single-axis solar tracker increases solar energy efficiency by about 25%, and the dual-axis tracker by about 40%.

This project assumes that you know the basics of Arduino programming.

All of the materials you need to complete the project are available in the set. You do not need to outsource material.

Introducing Set Contents



Solar Panel

Solar panel is an energy source that contains many solar cells that are used to absorb solar energy. A system of 3000 watts with 6-30 panels can satisfy all the electricity needs of a house or even a building.



Wooden Parts

Introducing Set Contents



Arduino Uno

With Arduino, students or professionals can make hobby, educational or professional projects with basic knowledge without having very detailed programming and electronic knowledge. Arduino Uno is the most widely used and best known model. It was launched in 2010.

Let me try to answer the question of what does Arduino Uno do? Arduino Uno can get physical information from various sensors, and you can do various experiments with this information. You can also get an output from stimuli such as motor, LED, buzzer.



IO Expanding Shield for Arduino

Arduino IO Expanding Shield is a very useful product designed for you to install many input and output units on the board that you can use with Arduino boards.

All input and output pins of Arduino on the board are transformed into 3-pins in the order of DATA, VCC and GND and distributed on the board. In this way, all kinds of sensors, servos, relays, etc. It can be used comfortably attached to the card.



Servo Motor

Servo is defined as a motion system that accurately controls angular-linear position, speed and acceleration in mechanisms. In other words, it is a movement controlled mechanism. Servo motors are the most used motor type in robot technologies, but they are also used in RC (Radio Control) applications. RC Servo Motors were first used in remote controlled model vehicles.

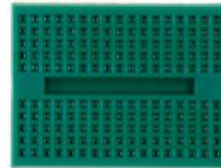

Mini Breadboard

The mini breadboard has 170 holes and has an adhesive bottom so you can stick it on a variety of surfaces. You can quickly prototype and run your circuits in your small circuit work and by pasting them on the circuit boards.



Jumper Cable

In short, we can call it a kind of connection cables. It is very useful for connecting between breadboard and Arduino. There are 3 types of jumper cables according to the presence of male and female inputs at the ends.

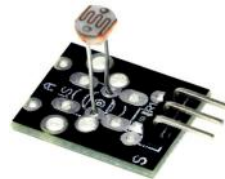

LDR Module

Photo resistor (LDR-Light Dependet Resistance) LDR light sensor card is a circuit element whose resistance changes depending on the light intensity falling on it. Like calcium sulfate in photo resistors, they contain components whose free electron number changes as light falls on them.

Introducing Set Contents



Metal Spacers

Metal spacers are materials that can be used to upgrade various circuit boards and mechanical materials. In Solarx you will use it to upgrade the servo motor.



Nuts - Bolts

Connecting elements that are used to connect parts to each other in a detachable manner, with a screw thread on the body part, hexagonal, rectangular or different shapes are called bolts. Bolts are usually used in conjunction with the nut.

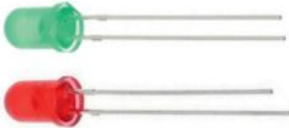

LED

LEDs appear everywhere in our daily lives - in our phones, in our cars and even in our homes. If an electronic device emits light, it is very likely that there is an LED behind it. Diode LEDs are like small bulbs. Low energy consumption, small size, fast connection and long lifetime are ideal for mobile devices and other low power applications.



Push Button

Push buttons are circuit elements that are only on when pressed and off when released. A push button can do the job of two switches alone. Short circuit of the pin faces only depends on pressing the button. When the button is pressed, pins 1 and 3 are connected to each other, that is, the circuit is completed. Similarly, pins 2 and 4 are connected to each other and the circuit is completed.



Resistor

Resistors are used to keep the current at a certain value by limiting the current in electrical circuits. Apart from this, they prevent high current flowing over sensitive circuit elements, they are also used to divide the supply voltage and current. Some resistors of different types (such as LDR, NTC, PTC) can control the physical changes in the external environment by acting as passive sensors. In addition, as the current value falling on the resistors increases, it is also benefited from their heating.



Buzzer

Buzzer is a small vibrator that can operate with voltage between 2 and 4 volts. It provides instantaneous current changes in a coil, resulting in weak vibrations.

Mechanical Installation Operations

Part Number List

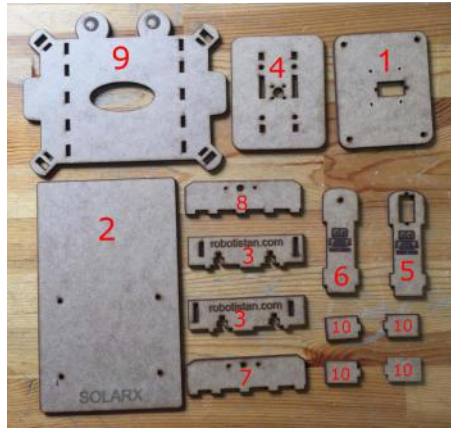

Assemble the Lower Body

First of all, we will install the servo motor in the number 1 part. Mount it using the two long screws that come out of the servo motor package.

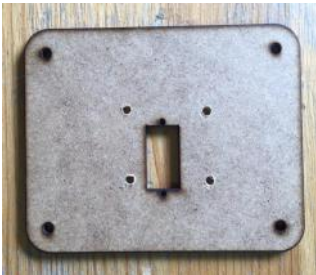

Mount the servo motor with 4 10 MM spacers and 4 nuts to the part number 1 where we mount it. These spacers will help the upper body to rotate more stable.



Mechanical Installation Operations

To raise the part number 1 from the bottom plate, mount 4 20 MM spacers using 4 nuts.



Next step is to assemble part number 1 on part number 2. Mount the part number 1 to the 20 mm spacers on the part number 2 by using 4 6 MM bolts. After this step, the assembly of the solarx lower body will be finished.

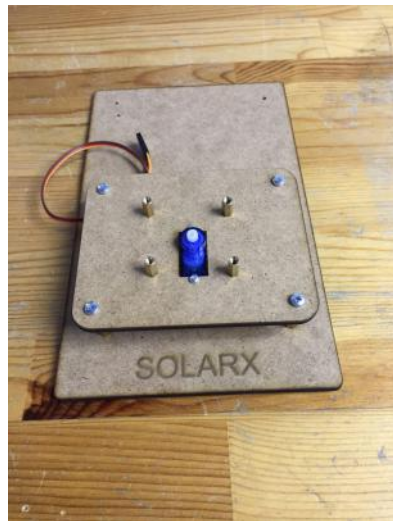

Mechanical Installation Operations

Upper Body Assembly

We can divide the upper body into two compartments. The first part is the part that moves the solar panel left and right. The second part can be thought of as the part that moves the solar panel up and down. In this step, I will explain the assembly of the first part.

The parts required in the assembly of the first part are the parts numbered 3, 4, 5, 6 and 4 10MM bolts, respectively.

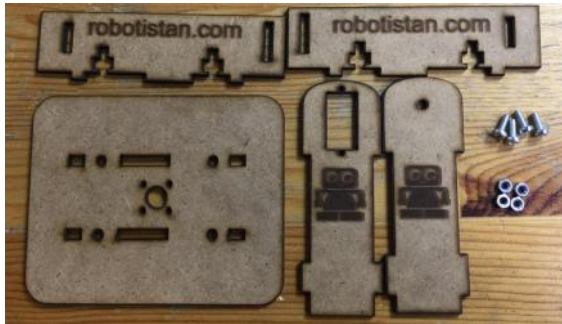

First of all, we fasten the pieces 3, 5 and 6 together as shown in the image. It is normal for the parts to fit together hard. You can apply some force. Then, assemble the assembled parts to the part number 4 using 10 MM bolts and nuts.



Mechanical Installation Operations

After the assembly of the first part is finished. Mount the servo head that comes out of the servo motor package to the part number 4 with the M2 bolt in the set as shown in the picture.



Then fix it to the part number 5, with the gear part of the servo motor upwards, with the screws that come next.



Mechanical Installation Operations

The first part of the upper part. Screw the servo motor, which you screwed into the part number 1, with the small screw that comes out of the servo package as shown in the picture.

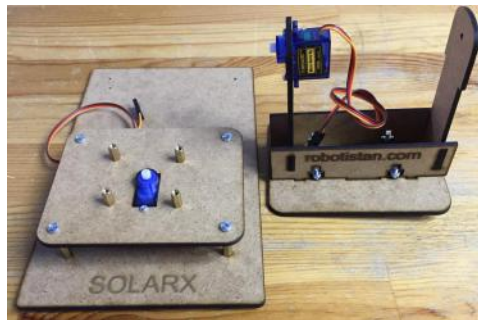
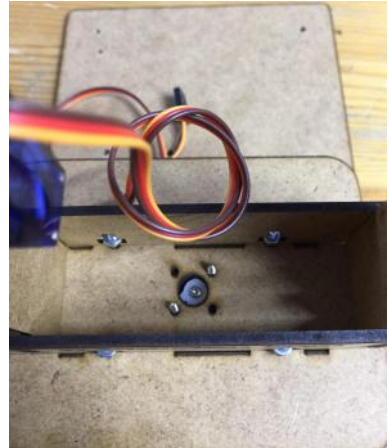
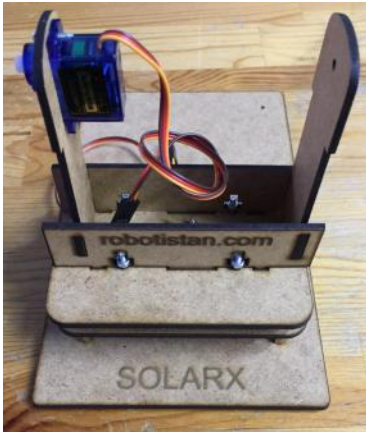

If you have completed all the steps so far, you can proceed to the assembly of the second part of the upper part. 7, 8, 9 and 10 for the assembly of the second section. M2 bolt in the set is required to screw the numbered parts, servo cap and servo cap.



Mechanical Installation Operations

In the first step, fix the pieces 7 and 8 by passing them through the holes on the unshaped side of the piece 9. The pieces can cross each other a little hard, so don't worry.

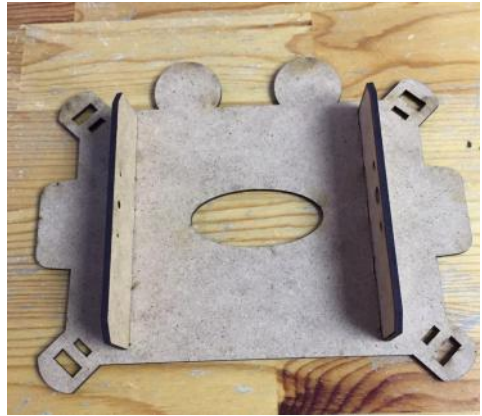

After fixing parts 7 and 8. Mount the servo head to the part number 8 with the M2 bolt in the set as shown in the image.



Fix the 15 mm bolt, which helps the part number 9 to move up and down, to the part number 7 with 1 nut as shown in the image. After this step, the assembly of the second part will be finished.



Mechanical Installation Operations

In this step you will merge the first and second part. We pass the 15 mm bolt you attached to the part number 7 through the hole on the 6 part as shown in the image and fix it with a nut. Please do not tighten this nut too much. Because if you squeeze it too much, it will not be able to move up and down comfortably. Then we attach the servo head in part 8 to the servo motor at number 5 and screw it with the tiny screw in the package.



As the last step of the mechanical installation, fix 2 6 mm bolts with 2 nuts to the part number 2 as shown in the picture. The reason we do this is because solarx stays still on flat surfaces without wobbling. After this step, the assembly of the mechanical parts will be finished.

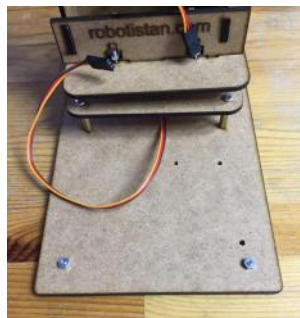

Mechanical Installation Operations

You can install and run all components modularly without the need for soldering on the electronics part. Arduino Uno model is used in SolarX. In addition, there is a breadboard that you can use while developing projects with the energy you get from the solar panel.

We do not use bolts while mounting the breadboard, it will be enough to stick it to the specified place with the double-sided tape on the back.

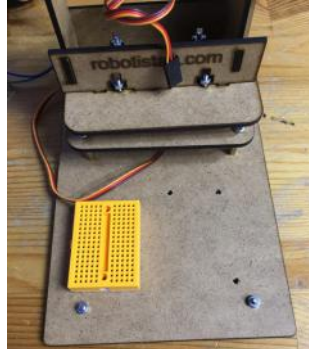
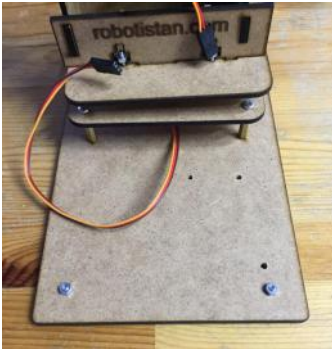

When fixing the Arduino, 4 6 mm spacers, 4 nuts and 4 6mm bolts are used. First of all, mount the 4 spacers to the solarx chassis with the nut. Then, screw the Arduino onto the spacers with 4 6 mm bolts. After assembling the Arduino, attach the shield to the Arduino.

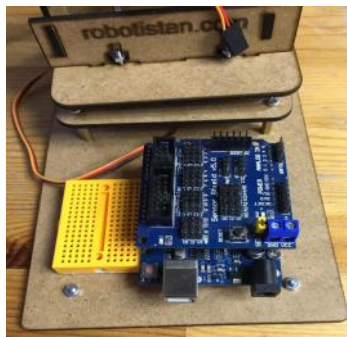
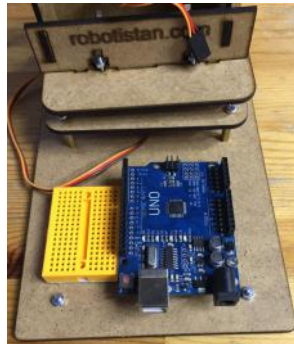
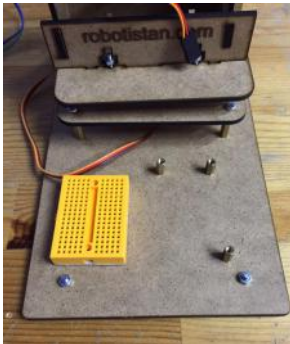

Circuit Diagram

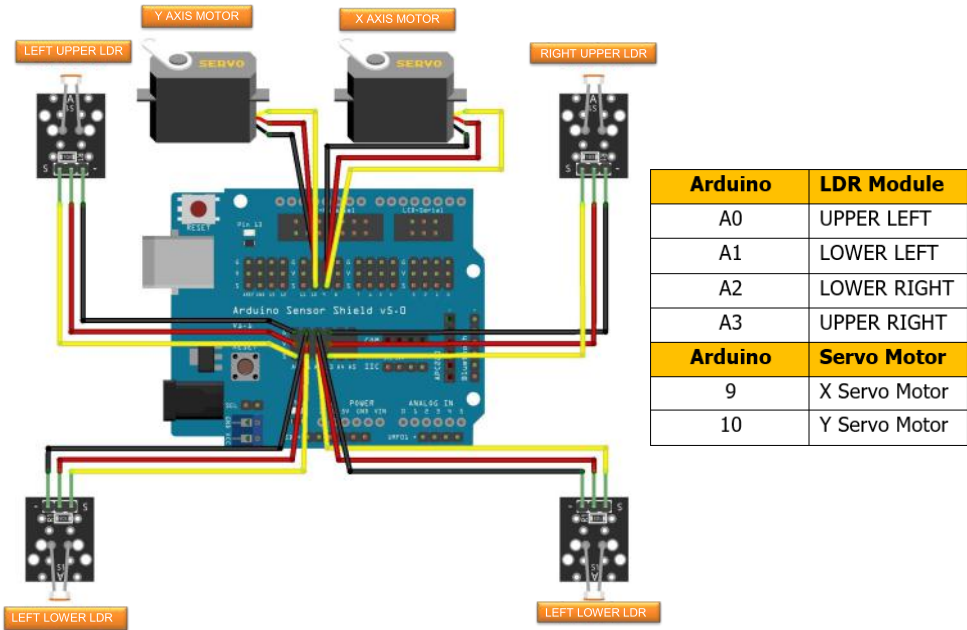

You can connect LDR and servo motors to Arduino Shield by getting help from the above diagram and connection table. Make your connections by paying attention to the directions of the LDR modules. Otherwise, your solar panel will rotate in the opposite direction.

Stick the LDR modules to the 10 numbered pieces with the double-sided tape included in the set, with the help of the visual below.

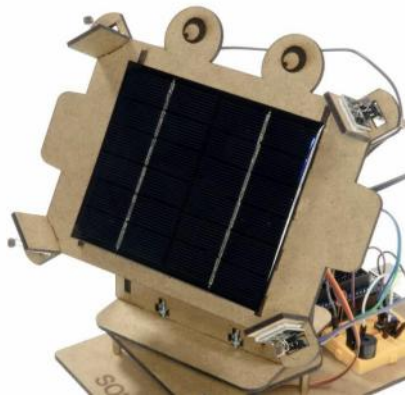
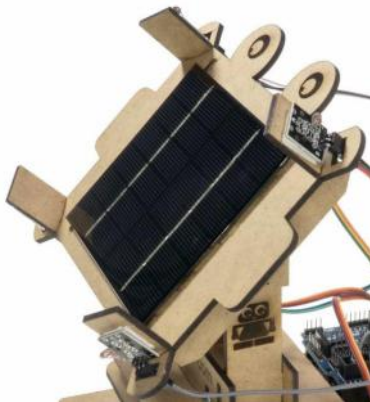

Electronic Assembly Operations

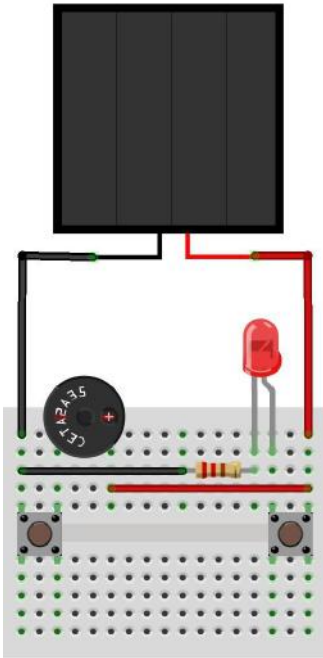

After you have made the connections of LDR and servo motors, you can start operating something with the energy you get from the solar panel.

It is up to your imagination to use the energy you get from the solar panel. Whether you store it, charge the battery or power your Arduino.

As an example, I drew a circuit diagram with the buzzer and LED included in the set. You can use the energy you get from the solar panel by getting help from the circuit diagram on the side.

When you do this project, with the energy you get from the sun, the buzzer will turn on when you press the first button and the LED will turn on when you press the second button.

In case you want to develop other projects with the energy you get from the sun, I added another project scheme as an example. You need a battery charging circuit to realize this project. Because the energy from the solar panel will not always be stable. If you want to charge the battery, you need stable energy. In addition, the battery compartment will also be required for convenient removal and installation of the battery. These products I am talking about will not come in the set. Set content is designed in such a way that you can operate buzzer and LED.

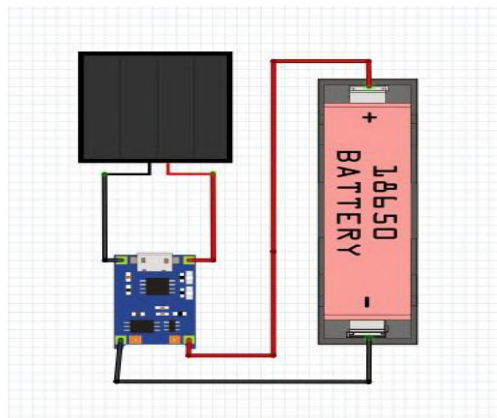

Uploading Software

You can type and develop the code written specifically for SolarX, with the help of the image below.

Dosya Düzenle Taslak Araçlar Yardım

```
sketch_apr28a$  
#include <Servo.h>  
//defining Servoss  
  
#define TOLERANCE      10  
#define STEP_DELAY     7  
Servo servohori;  
int servoh = 0;  
int servohLimitHigh = 160;  
int servohLimitLow = 20;  
  
Servo servoverti;  
int servov = 0;  
int servovLimitHigh = 160;  
int servovLimitLow = 20;  
//Assigning LDRs|  
int ldrtopl = A0; //top left LDR green  
int ldrtopr = A3; //top right LDR yellow  
int ldrbotl = A1; // bottom left LDR blue  
int ldrbotr = A2; // bottom right LDR orange  
  
void setup ()  
{  
  servohori.attach(10);  
  servohori.write(45);  
  servoverti.attach(9);  
  servoverti.write(45);  
  Serial.begin(9600);  
  delay(500);  
}  
  
void loop()  
{  
  servoh = servohori.read();  
  servov = servoverti.read();  
  //capturing analog values of each LDR  
  int topl = analogRead(ldrtopl);  
  int topr = analogRead(ldrtopr);  
  int botl = analogRead(ldrbotl);  
  int botr = analogRead(ldrbotr);  
  // calculating average
```

Uploading Software

```
// calculating average
int avgtop = (topl + topr) / 2; //average of top LDRs
int avgbot = (botl + botr) / 2; //average of bottom LDRs
int avgleft = (topl + botl) / 2; //average of left LDRs
int avgright = (topr + botr) / 2; //average of right LDRs
Serial.println(avgtop);

if (TOLERANCE < avgbot - avgtop)
{
  servoverti.write(servov + 1);
  if (servov > servovLimitHigh)
  {
    servov = servovLimitHigh;
  }
  delay(STEP_DELAY);
}

else if (TOLERANCE < avgtop - avgbot)
{
  servoverti.write(servov - 1);

  if (servoh > servohLimitHigh)
  {
    servoh = servohLimitHigh;
  }
  delay(STEP_DELAY);
}

else if (avgright - avgleft > TOLERANCE)
{
  servohori.write(servoh - 1);

  if (servoh < servohLimitLow)
  {
    servoh = servohLimitLow;
  }
  delay(STEP_DELAY);
}

else
{
  servohori.write(servoh);
}
delay(STEP_DELAY);
}
```

If you want, you can access the entire code via short link or QR code.

<https://www.kisa.link/ORxr>



Uploading Software

After installing SolarX according to this manual and uploading the code, the final version of SolarX will be as in the images below.

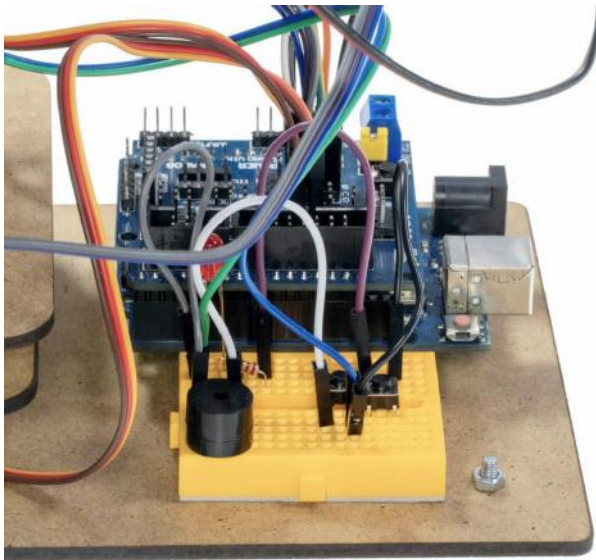
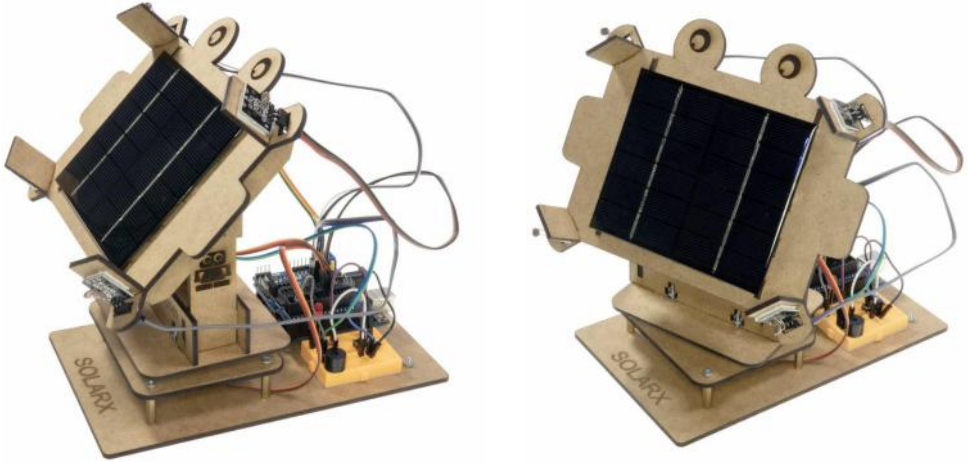

We're Here to Help
Feel free to reach out to us at
+90850 766 0 425 or
info@robotistan.com
For further information please visit:



youtube.com/robotistan



forum.robotistan.com



maker.robotistan.com