

AC-DC Rectifier

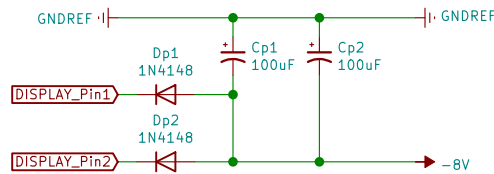

3V3 Regulator

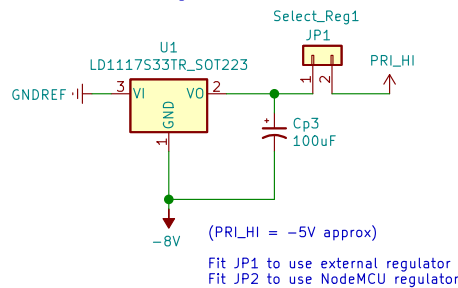

Power Header Pin

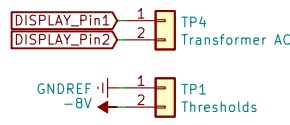

Display Header Pin

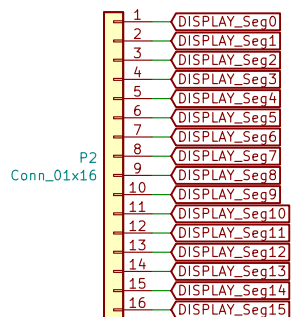

AC Threshold Converter

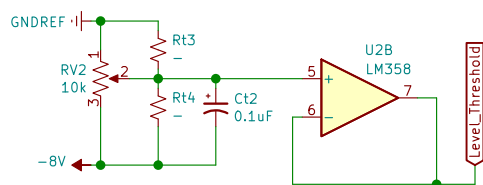
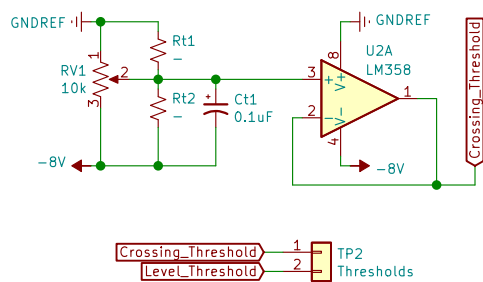

Level Comparator & Logic Optoisolator

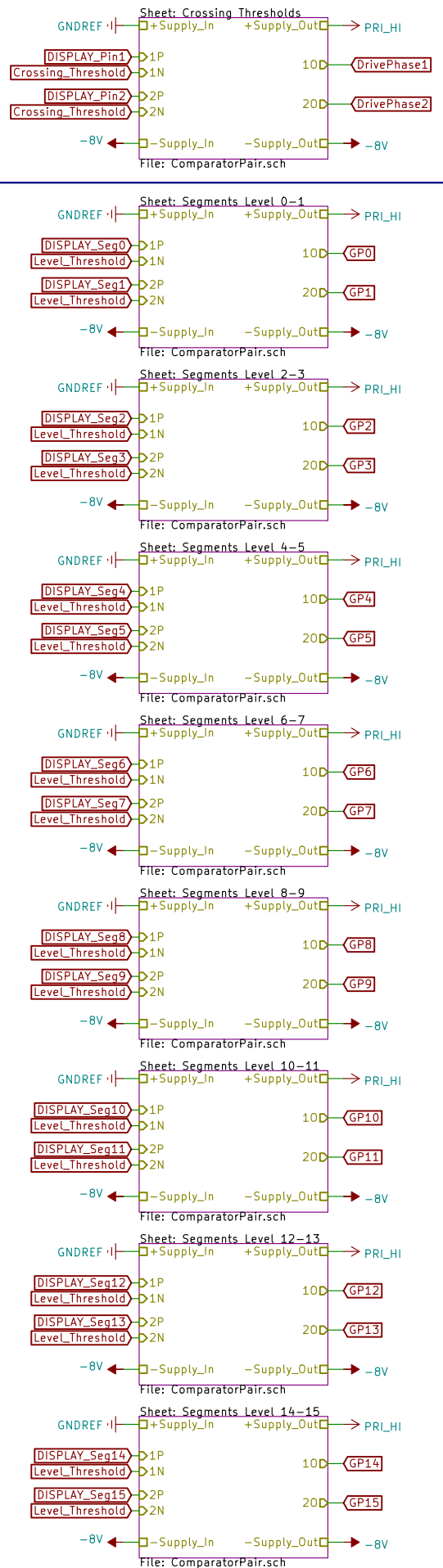

Analog Switch

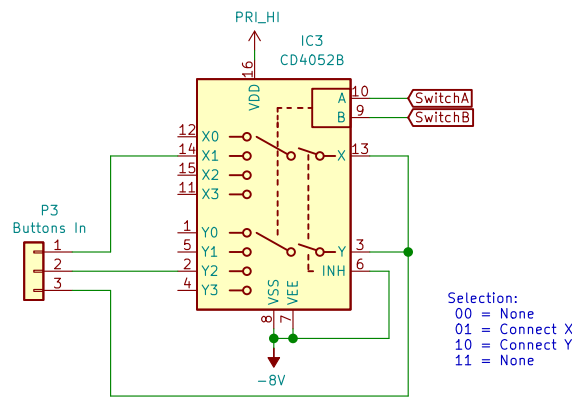

External LEDs

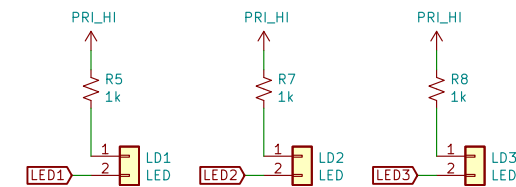

I2C I/O Port Expander

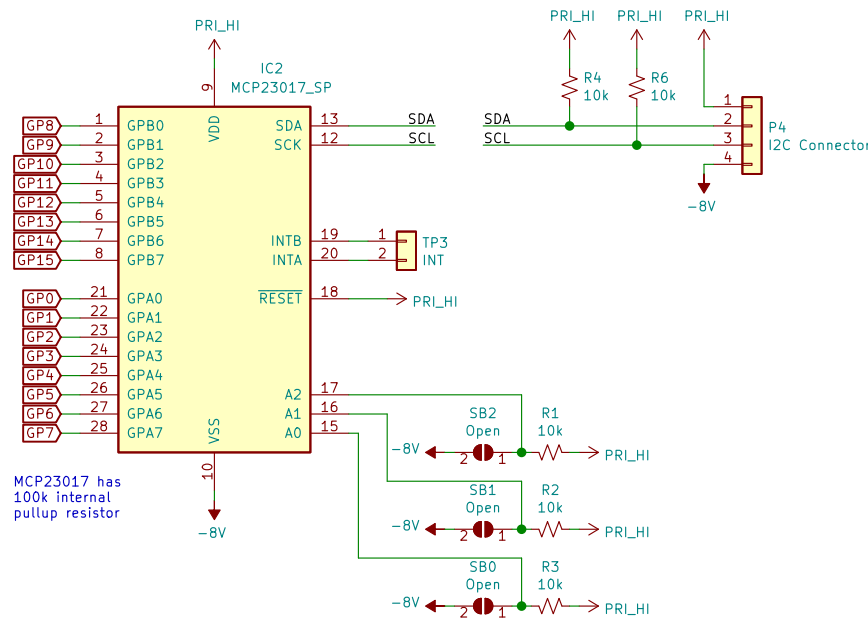

Microcontroller

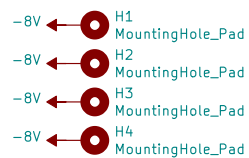
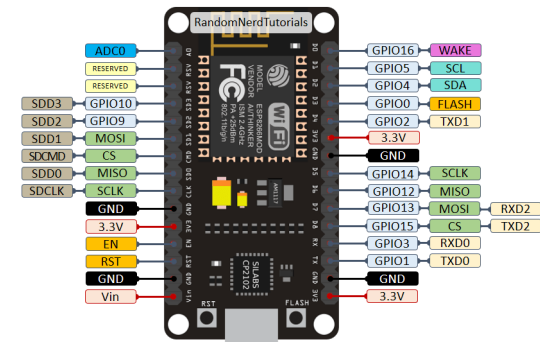
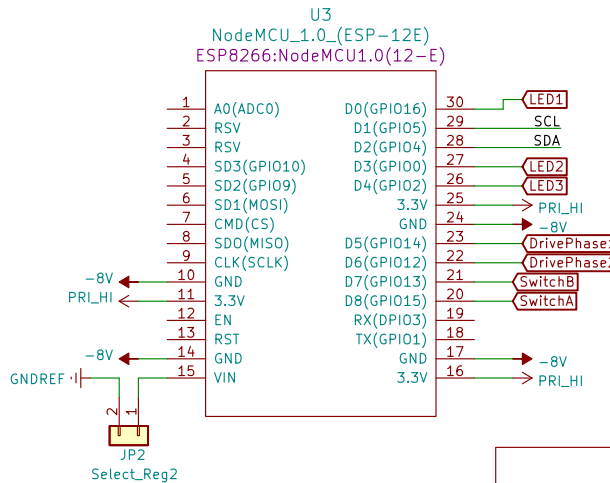

Power Source Legend

- PRL_HI ← 3V3 Voltage Regulator (sitting on -8Vdc as reference)
- 8V ← Transformer Rectified -8Vdc
- DISPLAY_Pin1 Transformer Half-wave Sine Phase 1
- DISPLAY_Pin2 Transformer Half-wave Sine Phase 2
- GNDREF Transformer Center Tap
- 8V ← Transformer Rectified -8Vdc

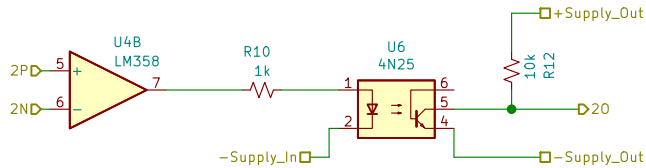
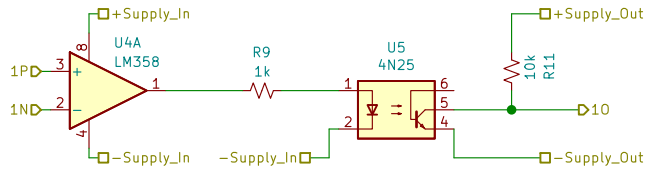

Sheet: /Segments Level 0-1/
 File: ComparatorPair.sch

Title:

Size: User	Date:	Rev:
KiCad E.D.A.	eeschema 5.1.7-a382d34a888ubuntu20.04.1	Id: 2/10

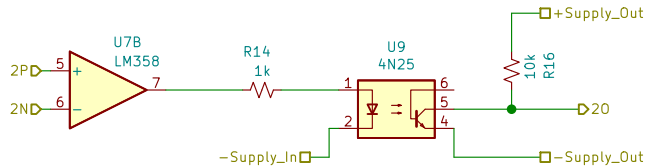
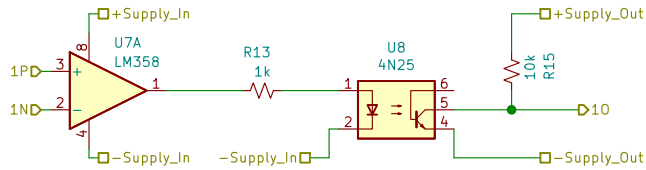

Sheet: /Crossing Thresholds/
 File: ComparatorPair.sch

Title:

Size: User	Date:
KiCad E.D.A. eeschema 5.1.7-a382d34a888ubuntu20.04.1	

Rev:
Id: 3/10

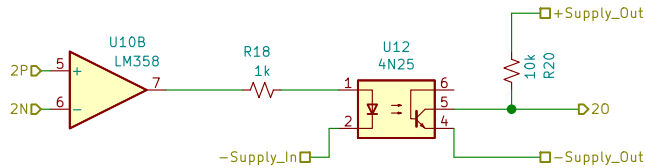
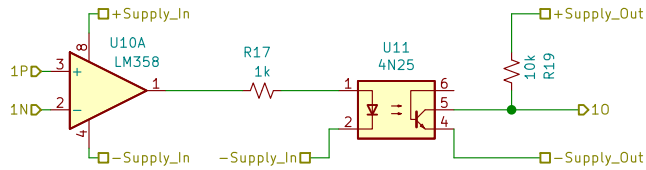

Sheet: /Segments Level 2-3/
 File: ComparatorPair.sch

Title:

Size: User
 KiCad E.D.A.

Date:
 eeschema 5.1.7-a382d34a888ubuntu20.04.1

Rev:
 Id: 4/10

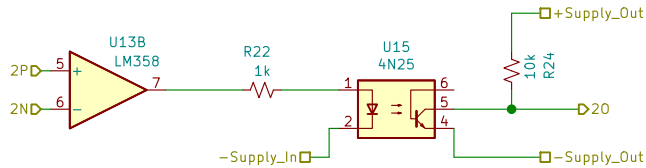
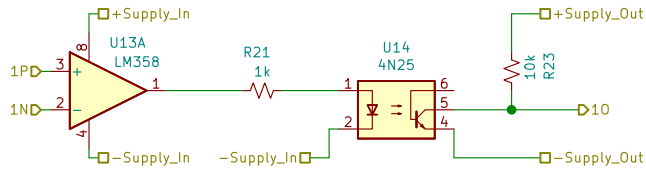

Sheet: /Segments Level 4-5/
 File: ComparatorPair.sch

Title:

Size: User Date:
 KiCad E.D.A. eeschema 5.1.7-a382d34a888ubuntu20.04.1

Rev:
 Id: 5/10

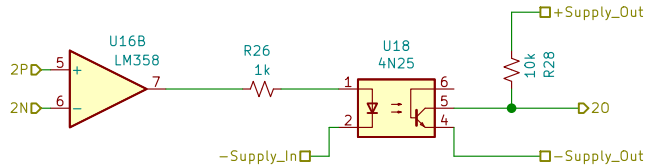
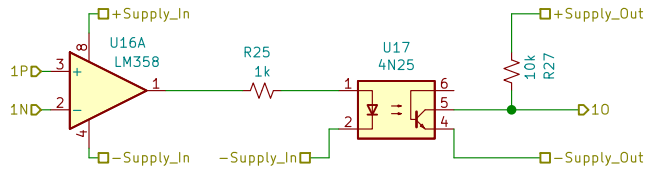

Sheet: /Segments Level 6-7/
 File: ComparatorPair.sch

Title:

Size: User	Date:	Rev:
KiCad E.D.A.	eeschema 5.1.7-a382d34a888ubuntu20.04.1	Id: 6/10

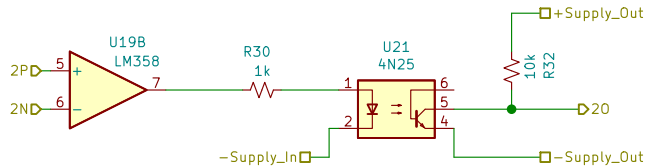
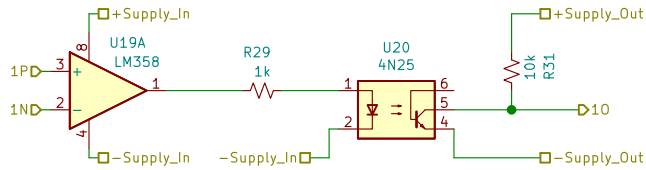

Sheet: /Segments Level 8-9/
 File: ComparatorPair.sch

Title:

Size: User	Date:
KiCad E.D.A. eeschema 5.1.7-a382d34a888ubuntu20.04.1	

Rev:
Id: 7/10

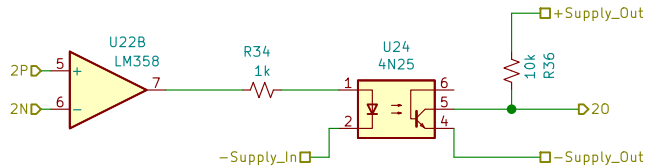
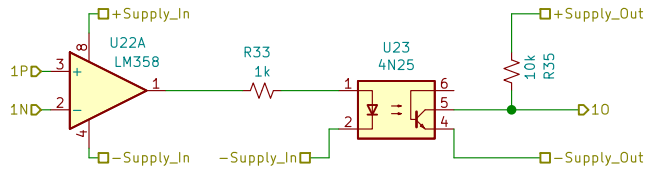

Sheet: /Segments Level 10-11/
 File: ComparatorPair.sch

Title:

Size: User	Date:
KiCad E.D.A. eeschema 5.1.7-a382d34a888ubuntu20.04.1	

Rev:
Id: 8/10

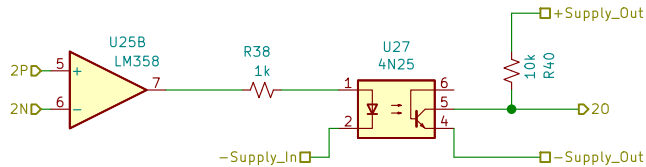
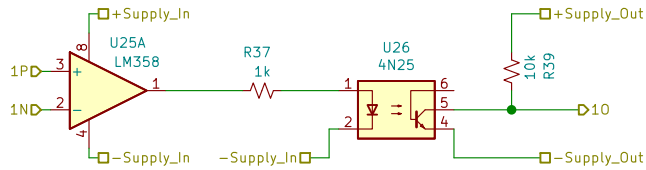

Sheet: /Segments Level 12-13/
 File: ComparatorPair.sch

Title:

Size: User	Date:
KiCad E.D.A. eeschema 5.1.7-a382d34a888ubuntu20.04.1	

Rev:
Id: 9/10

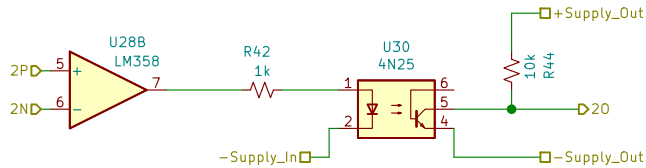
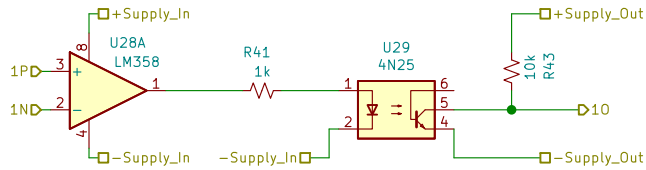

Sheet: /Segments Level 14-15/
 File: ComparatorPair.sch

Title:

Size: User	Date:
KiCad E.D.A. eeschema 5.1.7-a382d34a888ubuntu20.04.1	

Rev:
Id: 10/10