

Quick Reference

Quick Jumpers Setup:



Note :

P54C: Pentium Processor

P55C: Pentium Processor with MMX Technology

CPU Type/Speed	CPU Clock			Multiplier JP9	CPU Voltage		
	JP11	JP15	JP16		JP1	JP2	JP4
P54C 75MHz	2-3	2-3	2-3	open	open	open	1-2
P54C 90MHz	1-2	2-3	2-3	open	open	open	1-2
P54C 100MHz	2-3	1-2	2-3	open	open	open	1-2
P54C 120MHz	1-2	2-3	2-3	2-3	open	open	1-2
P54C 133MHz	2-3	1-2	2-3	2-3	open	open	1-2
P54C 150MHz	1-2	2-3	2-3	2-3, 4-5	open	open	1-2
P54C 166MHz	2-3	1-2	2-3	2-3, 4-5	open	open	1-2
P54C 200MHz	2-3	1-2	2-3	1-2, 4-5	2-3	open	1-2
P55C 166MHz 2.8V	2-3	1-2	2-3	2-3, 4-5	open	2-3	2-3
P55C 200MHz 2.8V	2-3	1-2	2-3	1-2, 4-5	open	2-3	2-3



CPU Type/Speed	CPU Clock			Multiplier JP9	CPU Voltage		
	JP11	JP15	JP16		JP1	JP2	JP4
6x86-P120+	2-3	2-3	2-3	2-3	2-3	open	1-2
6x86-P133+	2-3	2-3	1-2	2-3	2-3	open	1-2
6x86-P150+	1-2	2-3	2-3	2-3	2-3	open	1-2
6x86-P166+	2-3	1-2	2-3	2-3	2-3	open	1-2



CPU Type/Speed	CPU Clock			Multiplier JP9	CPU Voltage		
	JP11	JP15	JP16		JP1	JP2	JP4
AMD-K5-PR75	2-3	2-3	2-3	open	2-3	open	1-2
AMD-K5-PR90	1-2	2-3	2-3	open	2-3	open	1-2
AMD-K5-PR100	2-3	1-2	2-3	open	2-3	open	1-2
AMD-K5-PR120	1-2	2-3	2-3	open	2-3	open	1-2
AMD-K5-PR133	2-3	1-2	2-3	2-3	2-3	open	1-2
AMD-K5-PR150	1-2	2-3	2-3	2-3, 4-5	2-3	open	1-2
AMD-K5-PR166	2-3	1-2	2-3	2-3, 4-5	2-3	open	1-2

Quick BIOS Setup:

After hardware Setup is completed, turn the power switch on, then press key to access the AWARD BIOS SETUP program. A "CMOS SETUP UTILITY" will display on the screen.

1. Select "STANDARD CMOS SETUP" to set Date /Time and Floppy drive type, and also set Hard Disk Type to "Auto"
2. Select "LOAD SETUP DEFAULTS" and type "Y" to load BIOS optimal setup.
3. Select "SAVE & EXIT SETUP" and press the <Enter> key to save the setting information in the CMOS memory and continue with the booting process.

Copyright Notice

©Copyright 1996.

The information contained in the user's manual and all accompanying documentation is copyrighted and all rights are reserved. This publication may not, in whole or in part, be reproduced, transcribed, stored in a retrieval system, translated into any language or computer language, or transmitted in any form whatsoever without the prior written consent from the manufacturer, except for copies retained by the purchasers for their personal archival purposes.

The manufacturer reserves the right to revise this user's manual and all accompanying documentation and to make changes in the content without obligation to notify any person or organization of the revision or change.

IN NO EVENT WILL THE VENDOR BE LIABLE FOR DIRECT, INDIRECT, SPECIAL, INCIDENTAL, OR CONSEQUENTIAL DAMAGES ARISING OUT OF THE USE OR INABILITY TO USE THIS PRODUCT OR DOCUMENTATION, EVEN IF ADVISED OF THE POSSIBILITY OF SUCH DAMAGES. IN PARTICULAR, THE VENDOR SHALL NOT HAVE LIABILITY FOR ANY HARDWARE, SOFTWARE, OR DATA STORED OR USED WITH THE PRODUCT, INCLUDING THE COSTS OF REPAIRING, REPLACING, OR RECOVERING SUCH HARDWARE, SOFTWARE, OR DATA.

All trademarks mentioned in this document are acknowledged.

■ Table Of Contents

Chapter 1

Introduction

1.1 Overview	5
1.2 P5F72 Specifications/Features	6
1.3 P5F72 Mainboard Layout	8
1.4 Microprocessor	9
1.5 Level 2 Cache	9
1.6 Chipset	10
1.7 Main Memory	10
1.8 Enhanced IDE Support	11
1.9 Universal Serial Bus Support	12
1.10 Real-time Clock, CMOS RAM and Battery	12
1.11 IrDA Infra-red Support	12

Chapter 2

Hardware Installation

2.1 Unpacking	13
2.2 Installation	13
2.2.1 Setting Jumpers	15
2.2.2 Attaching Connectors	24
2.2.3 Installing CPU	29
2.2.4 Tips for CPU Installation	30
2.2.5 Installing System Memory	31
2.2.6 Clear CMOS and Password	35

Chapter 3

BIOS Configuration

3.1 Entering Setup	36
3.2 CMOS Setup Utility	37
3.3 Standard CMOS Setup	38
3.4 IDE HDD Auto Detection	41

3.5 Load Setup Defaults	41
3.6 Save & Exit Setup	42
3.7 Exit Without Saving	42
3.8 HDD Low Level Format	42
3.9 BIOS Features Setup	43
3.10 Chipset Features Setup	46
3.11 Power Management Setup	47
3.12 PnP/PCI Configuration	50
3.13 Integrated Peripherals	52
3.14 Supervisor / User Password	54

Chapter 4

Driver and Utility

4.1 Flash Utility	55
4.2 EIDE Bus Master Driver	55
4.3 Soft Off Control	56

1 Introduction

1.1 Overview

The P5F72 is a quality, high performance, function enhanced mainboard based on the Pentium class processor. This mainboard is designed around the latest and fastest Intel 82430VX chipset in a 3/4 baby ATX form factor.

The P5F72 mainboard is a flexible mainboard which is designed to operate with all members of the Pentium class processors: Intel P54C (Pentium), P54CT (Pentium OverDrive), P54CTB (Pentium OverDrive with MMX Technology), and P55C (Pentium with MMX Technology), Cyrix/IBM 6x86 and 6x86L, and AMD K5.

The P5F72 mainboard delivers superior performance with its integrated Bus Mastering EIDE (Enhanced IDE) controller, concurrent PCI bus, 256/512KB level 2 Pipelined Burst cache, and its ability to accommodate new technology EDO (Extended Data Out) and SDRAM (Synchronous DRAM) memory.

The P5F72 mainboard offers outstanding I/O capabilities. It contains a full set of PC I/O, such as dual channel PCI EIDE interfaces, a floppy controller, two FIFOed serial ports, an EPP/ECP capable bidirectional parallel port, an IrDA compatible infrared port, two USB (Universal Serial Bus) ports, a PS/2 keyboard connector and a PS/2 mouse connector. Four PCI local bus slots and four full length ISA bus slots provide expandability to add on peripheral cards.

In addition to superior hardware capabilities, features like bus mastering EIDE driver, Plug and Play, Soft-off, APM (Advanced Power Management), and BIOS upgradability are provided on the P5F72 platform.

1.2 P5F72 Specifications/Features

Hardware

CPU	Supports the following CPUs in a ZIF Socket 7 Intel Pentium P54C/P54CT/P54CTB/P55C - 75/90/ 100/120/133/150/166/180/200 MHz Cyrix/IBM 6x86/6x86L - P120/P133/P150/P166 AMD K5 - PR100/PR120/PR133/PR150/PR166
Coprocessor	CPU built-in floating point unit
Speed	System bus clock 50/55/60/66 MHz PCI bus clock 25/27.5/30/33 MHz ISA bus clock 7.5/8.33/9.15 MHz
Chipset	Intel's 82430VX PCIsset Winbond's 83877 I/O chip
L2 Cache	Pipelined Burst SRAM 256/512KB
DRAM	4 x 72-pin SIMM and 2 x 168-pin DIMM sockets Supports 8MB to 128MB memory Supports FPM, EDO and SDRAM DRAMs
EIDE Controller	Supports four IDE devices in two channels Supports PIO mode 0 through mode 4 drives Supports Bus Mastering DMA mode 2 drives
Enhanced I/O	One floppy disk controller One Standard/EPP/ECP bidirectional parallel port Two 16550 compatible high speed serial ports One IrDA compatible Infrared port Two USB (Universal Serial Bus) ports
Mouse/Keyboard	PS/2 mouse connector PS/2 keyboard connector
Expansion Slots	Four 32-bit PCI slots Four 16-bit ISA slots (one PCI/ISA shared slot)

Options External Infrared port cable with mounting bracket
External dual USB ports cable with mounting bracket

Software

BIOS AWARD Pentium PCI BIOS
Flash BIOS with ESCD (Extended System Configuration Data) block
Supports APM, PnP, and EIDE devices
Built-in NCR SCSI BIOS

Driver Bus mastering EIDE driver

Utility Flash utility for BIOS upgrade

O.S. Operates with MS_DOS, Windows 3.x, Windows for Work Groups 3.x, Windows 95, Windows NT, OS/2, Novell Netware, Novell UnixWare 1.1 and SCO Unix 4.2

Environment

Ambient Temperature	0 ⁰ C to 50 ⁰ C (Operating)
Relative Humidity	0 to 85% (Operating)
Vibration	0 to 500 Hz
DC Voltage	4.9V to 5.2V
DC Voltage	3.15V to 3.50V
DC Voltage	-5V, +12V, -12V, +5V _{SB} 5% tolerance.

1.3 P5F72 Mainboard Layout

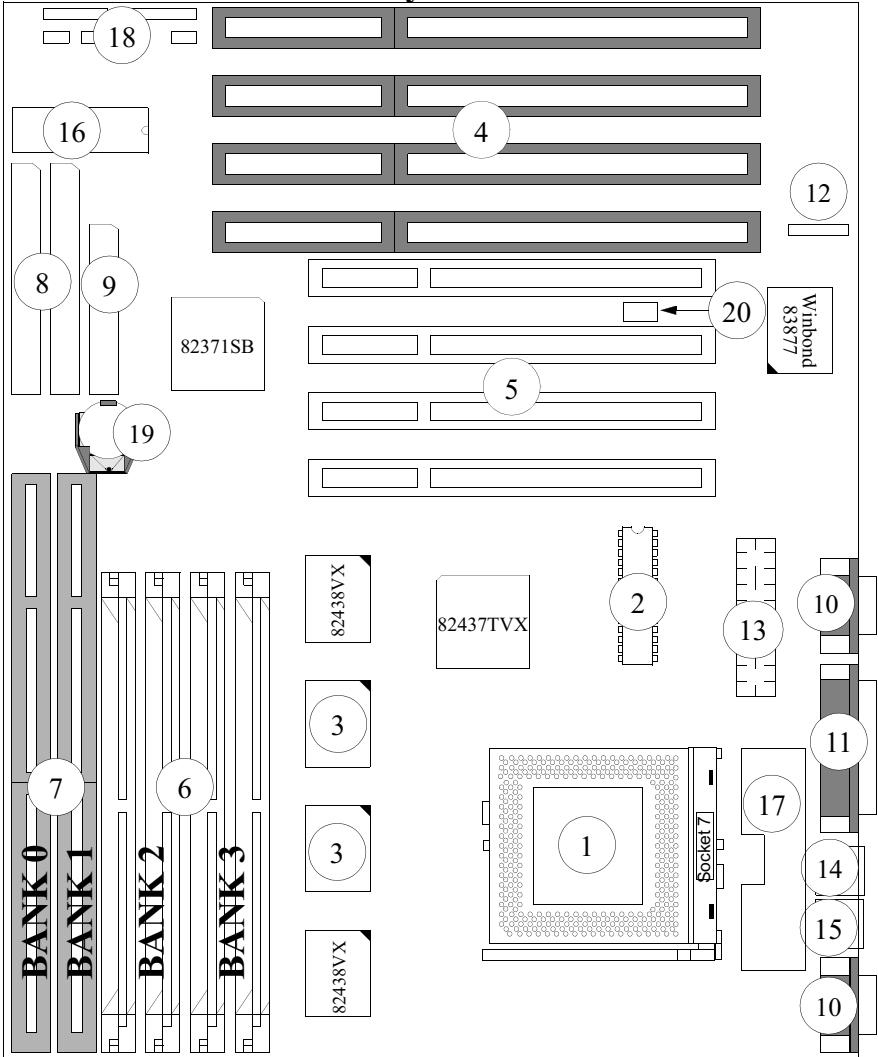

- | | | |
|-----------------------|---------------------------|-------------------------------|
| 1:CPU | 8:IDE Connectors | 15: PS/2 Mouse Connector |
| 2:TAG SRAM Chip | 9:Floppy Drive Connector | 16: Flash BIOS |
| 3:Cache SRAM Chips | 10:Serial Port Connectors | 17:CPU Core Voltage Regulator |
| 4:ISA Expansion Slots | 11:Paralle Port Connector | 18:Front panel Connectors |
| 5:PCI Expansion Slots | 12:IR Port Connector | 19:Battery (CR2032 Lithium) |
| 6:SIMM Module Sockets | 13:ATX Power Connector | 20:USB Header |
| 7:DIMM Module Sockets | 14:Keyboard Connector | |

1.4 Microprocessor

The P5F72 meets the requirements of a Pentium flexible mainboard. A Pentium flexible mainboard is defined as a mainboard capable to support all members of the Pentium class processors.

The requirements for a Pentium flexible mainboard are:

1. CPU ZIF socket is Socket 7.
2. BIOS can supports various Pentium class processors with different CPU core frequency.
3. On-board two voltage regulators and heat sinks meet CPU's core and I/O voltage/current/thermal specifications.

A cooling fan and heat sink assembly is required to protect the CPU from being damaged due to overheat.

P-rating: The “P-rating” is a new performance rating scale. It expresses the performance of AMD or Cyrix/IBM Pentium class CPU relative to Intel Pentium CPU. For example, the Cyrix/IBM 6x86 P166+ can reach the same or better performance than Intel Pentium 166 MHz. But the actual Cyrix/IBM 6x86 P166+ internal core clock is only 133MHz.

1.5 Level 2 Cache

The P5F72 mainboard provides standard 256KB or 512KB synchronous pipelined SRAM cache on board.

1.6 Chipset

The Intel 82430VX PCIset consists of one 82437VX System Controller (TVX), two 82438VX Data Path Unit (TDX), and one 82371SB PCI ISA/IDE Accelerator (PIIX3).

- | | |
|------------------|--|
| 82437VX (TVX): | <ul style="list-style-type: none">- CPU interface controller- Cache and DRAM controllers- Fully synchronous PCI bus interface |
| 82438VX (TDX): | <ul style="list-style-type: none">- Extensive CPU-to-DRAM, PCI-to-DRAM and CPU-to-PCI data buffering |
| 82371SB (PIIX3): | <ul style="list-style-type: none">- Interface between the PCI and ISA buses- USB controller- EIDE controller- Seven DMA channels, one timer/counter, two eight-channel interrupt controllers, NMI logic, SMI interrupt logic, and PCI/ISA bus arbitrator. |

1.7 Main Memory

The P5F72 mainboard provides four 72-pin SIMM and two 168-pin DIMM sockets to support 8MB to 128MB of system memory. The sockets support 1M x 32 (4MB), 2M x 32 (8MB), 4M x 32 (16MB), 8M x 32 (32MB) SIMM and 1M x 64 (8MB), 2M x 64 (16MB), 4M x 64 (32MB), 8M x 64 (64MB) DIMM single- or double-sided modules.

The P5F72 supports three types of DRAMs, Fast Page Mode (FPM), Extended Data Out (EDO), and Synchronous DRAM (SDRAM). Memory Timing requires 70ns or faster for FPM and EDO, and 66.7MHz speed grade for SDRAMs.

The four SIMM sockets are divided into two banks of two sockets each. The sockets are designated Bank 2 and Bank 3. **Both SIMMs in a bank must be of the same memory size, type and speed.**

There are no jumper settings required for the memory size or type, which is automatically detected by the BIOS.

EDO DRAM is designed to improve the DRAM read performance. It holds the memory data valid until the next memory access cycle, unlike FPM DRAM that tri-states the memory data when the precharge cycle occurs, prior to the next memory access cycle.

SDRAM use the system clock to synchronize the flow of addresses, data, control and pipelining of operation. This yields a significant memory performance increase.

1.8 Enhanced IDE Support

The P5F72 mainboard provides two enhanced high performance PCI IDE interfaces capable of supporting four PIO mode 0 through mode 4 and bus-mastering DMA mode 2 ATAPI devices. Detection of IDE device type and transfer rate (PIO mode) is automatically performed by the BIOS.

The traditional PIO IDE requires a substantial amount of CPU bandwidth to handle all the activities of IDE access including waiting for mechanical activity. The Bus Master logic designed in the Intel 82430VX chipset is intended to reduce the workload of the CPU, and to increase CPU efficiency. The Bus Master will take care of the data transfer between IDE and memory and let the CPU handle other tasks. In true multi-tasking operating systems such as Windows 95, Windows NT, and OS/2, by using bus-mastering IDE, the CPU bandwidth can be freed up to complete other tasks while disk data transfers are occurring. In order to make the EIDE drive operate at bus-mastering DMA mode 2, the driver must be loaded properly.

1.9 Universal Serial Bus Support

The P5F72 provides two USB ports. The USB is a serial bus interface standard that is designed to bring the “Plug and Play” concept to the outside of the computer system chassis. The bus allows devices to be attached, configured, used and also detached while the host system is in operation.

The USB will allow as many as 63 devices to be daisy chained in any combination per port. Up to 12Mbits/sec transfer rate, makes it suitable for devices such as keyboard, mouse, digital joystick, game pad, fax/modem, scanner, printer, ISDN and telephony device.

1.10 Real-time Clock, CMOS RAM and Battery

The integrated real-time clock (RTC) provides a time of day clock, 100-year calendar with alarm features. The RTC also has 242 bytes battery backed CMOS RAM which stores the system setup information and password. The RTC and CMOS RAM can be set via the BIOS SETUP program. The content of the CMOS RAM can be cleared by placing a shunt to short pin1 and pin2 of JP17 for 5 seconds when the system power is off.

An external coin-cell style Lithium CR2302 battery is used to provide power to the RTC and CMOS memory. The battery has three years lifetime if the system does not power up. When the system powers up, the power for the RTC and CMOS RAM is supplied from the 5 V power supply to extend the life of the battery.

1.11 IrDA Infra-red Support

A 5-pin header connector is used to connect a Hewlett Packard HSDSL-1000 compatible IrDA Infrared module. Once the module is installed, the user can use application software such as Laplink to transfer files between the computer system and portable devices such as laptops and printers. The Serial port 2 must be configured to support an IrDA module via the BIOS SETUP program.

2 Hardware Installation

2.1 Unpacking

The P5F72 mainboard package contains the following:

- * P5F72 mainboard
- * One IDE 40-pin ribbon cable
- * One floppy 34-pin ribbon cable
- * User's manual

Before removing the mainboard from its anti-static bag, you need to eliminate any static electricity that may be accumulated on your body by touching a grounded or anti-static surface. If nothing is available, touch the housing of the power supply which is plugged into the AC outlet.

After removing the mainboard from its anti-static bag, place it only on a grounded or anti-static surface, component side up. Inspect the mainboard to see if it is damaged, call the vendor immediately if it is damaged.

2.2 Installation

The P5F72 is designed to fit into a standard ATX form factor chassis. The pattern of the mounting holes and the position of the back panel connectors match the ATX system board specification. Chassis may come with various mounting fasteners which are made of metal or plastic. It is highly recommended to use as many metal fasteners as possible to mount the mainboard in the chassis for better grounding.

To install the mainboard you need to set jumpers, attach connectors, install CPU and SIMM/DIMM memory modules.

P5F72 Mainboard Jumper Location

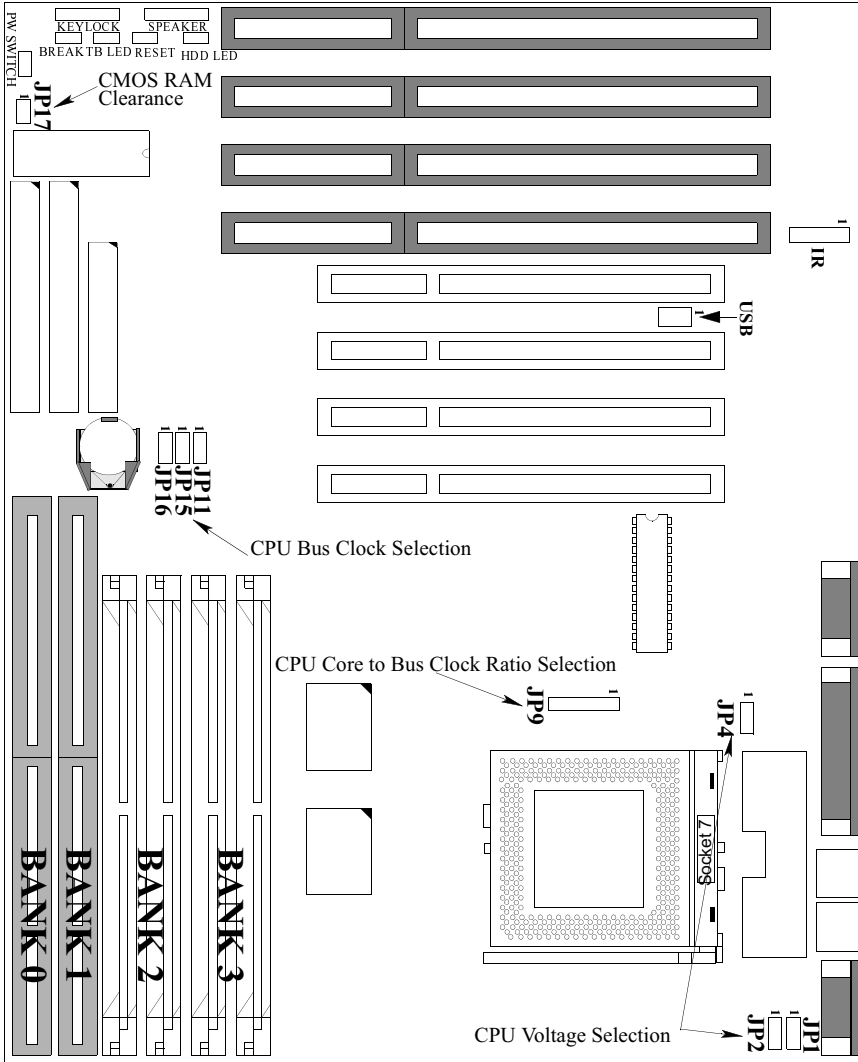

2.2.1 Setting Jumpers

This section provides the jumper settings for the P5F72 mainboard.

You need to configure jumpers to set

- 1) CPU core to bus clock multiplier
- 2) CPU bus clock
- 3) CPU core and I/O voltage

CPU Core to Bus Clock Multiplier: The CPU internal core clock is equal to the “CPU Bus Clock” times the “CPU Core to Bus Clock Multiplier”. For example, if the CPU Bus Clock is 66.6MHz and the CPU Core to Bus Multiplier is 3, the actual CPU core clock will be $66.6 \times 3 = 200\text{MHz}$.

CPU Bus Clock: The CPU Bus Clock is defined as the CPU input clock. For example: the CPU Bus Clock for Intel Pentium 100, 133 and 166 MHz are 66.6 MHz.

CPU Core and I/O Voltages: Two voltages V_{core} and $V_{\text{I/O}}$ are required for Pentium class CPUs. The V_{core} is used for CPU internal operation and the $V_{\text{I/O}}$ is used to supply the voltage for external interface.











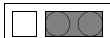

CPU Core to Bus Clock Multiplier Selection

Jumper JP9 is used to set CPU core to bus clock multiplier.

Intel	x 1.5	x 2.0	x 2.5	x 3.0
AMD	x 1.5	x 1.5	x 1.75	x 2.0
Cyrix/IBM	NA	x 2.0	x 2.5	x 3.0
	JP9	JP9	JP9	JP9

CPU Bus Clock Selection

Jumpers JP11, JP15, JP16 are used to set CPU Bus Clock.

CPU Bus Clock	PCI Bus Clock	ISA Bus Clock	Jumper Setting JP11/JP15/JP16
50MHz	25MHz	8.33MHz	1  JP11 1  JP15 1  JP16
55MHz	27.5MHz	9.16MHz	1  JP11 1  JP15 1  JP16
60MHz	30MHz	7.5MHz	1  JP11 1  JP15 1  JP16
66.6MHz (default)	33.3MHz	8.33MHz	1  JP11 1  JP15 1  JP16

CPU Core and I/O Voltage Selection

Jumpers JP1, JP2, JP4 are used to set voltage for the CPU.

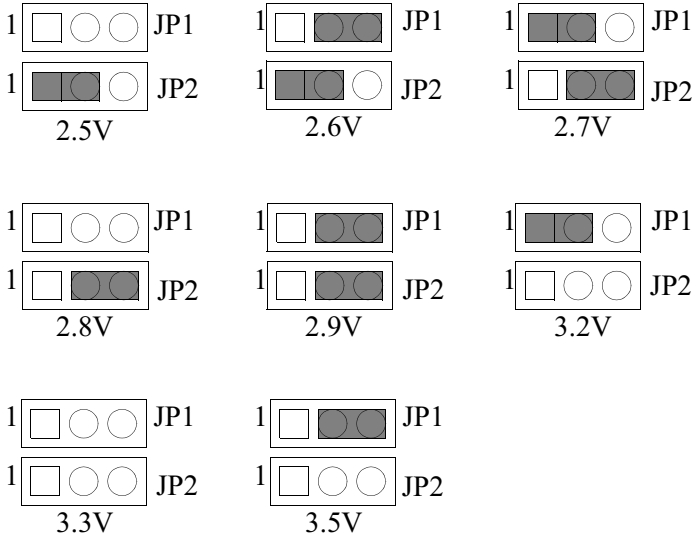

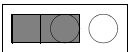
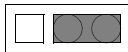
$V_{core} = V_{I/O}$  JP4 $V_{core} \neq V_{I/O}$  JP4

Single Operating Voltage CPUs













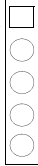



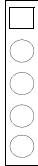

- Intel Pentium Processor
- Cyrix/IBM 6x86
- AMD K5

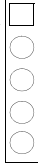



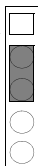



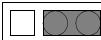

Dual Operating Voltage CPUs

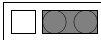
- Intel Pentium Processor with MMX Technology
- Cyrix/IBM 6x86L & M2
- AMD K5 - PRxx xHx



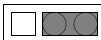



intel[®] Pentium CPU Clock/Voltage Jumper Setting

Intel Pentium CPU clock jumper setting

CPU Speed	JP11/JP15/JP16	JP9
Pentium -75 50MHz x 1.5	1  JP11 1  JP15 1  JP16	1 
Pentium -90 60MHz x1.5	1  JP11 1  JP15 1  JP16	1 
Pentium -100 66MHz x 1.5	1  JP11 1  JP15 1  JP16	1 
Pentium - 120 60MHz x 2	1  JP11 1  JP15 1  JP16	1 
Pentium -133 66MHz x 2	1  JP11 1  JP15 1  JP16	1 

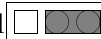



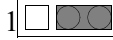



















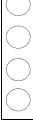





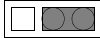

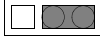
CPU Speed	JP11/JP15/JP16	JP9
Pentium - 150 60MHz x 2.5	1  JP11 1  JP15 1  JP16	1 
Pentium -166 66MHz x 2.5	1  JP11 1  JP15 1  JP16	1 
Pentium -200 66MHz x 3	1  JP11 1  JP15 1  JP16	1 

Intel Pentium CPU voltage jumper setting











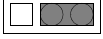

CPU Voltage (Volts)	JP1/JP2	JP4
3.3 V (Pentium)	1  JP1 1  JP2	1  JP4
3.5 V (Pentium)	1  JP1 1  JP2	1  JP4
3.3 V I/O 2.8 V Core (Pentium with MMX Technology)	1  JP1 1  JP2	1  JP4

AMD[®] CPU Clock/Voltage Jumper Setting











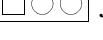

AMD CPU Clock Jumper Setting

CPU Speed	JP11/JP15/JP16	JP9
AMD-K5-PR75 50MHz x 1.5	1  JP11 1  JP15 1  JP16	1  
AMD-K5-PR90 60MHz x 1.5	1  JP11 1  JP15 1  JP16	1  
AMD-K5-PR100 66MHz x 1.5	1  JP11 1  JP15 1  JP16	1  
AMD-K5-PR120 60MHz x 1.5	1  JP11 1  JP15 1  JP16	1  
AMD-K5-PR133 66MHz x 1.5	1  JP11 1  JP15 1  JP16	1   
AMD-K5-PR150 60MHz x 1.75	1  JP11 1  JP15 1  JP16	1   

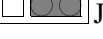
AMD CPU Clock Jumper Setting Cont'd

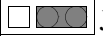
CPU Speed	JP11/JP15/JP16	JP9
AMD-K5-PR166 66MHz x 1.75	1  JP11 1  JP15 1  JP16	1 
AMD-K6-PR2-200 66MHz x 3	1  JP11 1  JP15 1  JP16	1 
AMD-K6-PR2-233 66MHz x 3.5	1  JP11 1  JP15 1  JP16	1 



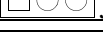
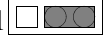













AMD CPU voltage Jumper Setting

CPU Voltage (Volts)	JP1/JP2	JP4
3.5 V AMD-K5-PRxx xBx	1  JP1 1  JP2	1  JP4
3.3 V AMD-K5-PRxx xFx	1  JP1 1  JP2	1  JP4
3.3 V I/O 2.92 V Core AMD-K5-PRxx xHx	1  JP1 1  JP2	1  JP4
2.9 V AMD-K6-PR2-XXX	1  JP1 1  JP2	1  JP4
3.2 V AMD-K6-PR2-XXX	1  JP1 1  JP2	1  JP4









6x86 CPU Clock/Voltage Jumper Setting

Cyrrix/IBM 6x86 CPU clock jumper setting

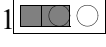
CPU Speed	JP11/JP15/JP16	JP9
6x86 - P120+ 100MHZ = 50 x 2	1  JP11 1  JP15 1  JP16	1 
6x86 - P133+ 110MHz = 55 x 2	1  JP11 1  JP15 1  JP16	1 
6x86 - P150+ 120MHz = 60 x 2	1  JP11 1  JP15 1  JP16	1 
6x86 - P166+ 133MHz = 66 x 2	1  JP11 1  JP15 1  JP16	1 

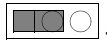
Cyrilx/IBM 6x86 CPU voltage jumper setting

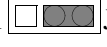
CPU Voltage (Volts)	JP1/JP2	JP4
3.3 V (6x86)	1  JP1 1  JP2	1  JP4
3.5 V (6x86)	1  JP1 1  JP2	1  JP4
3.3 V I/O 2.8 V Core (6x86L, M2)	1  JP1 1  JP2	1  JP4

2.2.2 Attaching Connectors

Front Panel Connectors

There are 7 connectors on the mainboard for switches and indicator lights on the system's front panel.

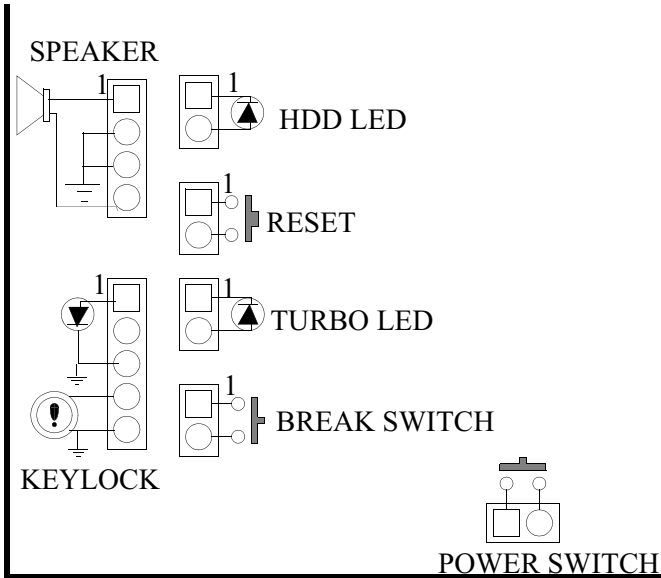

Speaker Connector

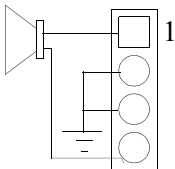

Pin Assignment

1. Speaker out
2. Ground
3. Ground
4. +5V

Keylock Connector

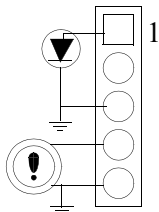

Pin Assignment

1. LED Cathode
2. N. C.
3. LED Anode (Ground)
4. Keylock
5. Ground

HDD LED Connector

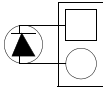

- Pin Assignment
1. LED Anode
 2. LED Cathode

Reset Connector



- Pin Assignment
1. Power Good
 2. Ground

Turbo LED Connector

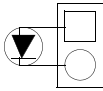

- Pin Assignment
1. LED Cathode
 2. LED Anode (Ground)

Break Switch Connector

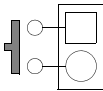

- Pin Assignment
1. Break
 2. Ground

Power Switch Connector

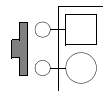

- Pin Assignment
1. Power On/Off
 2. Ground

The front panel on your case may have a turbo switch to deactivate the Turbo mode when a slower speed is required for a specific application. The Intel 82430VX chipset does not support the hardware deturbo function. An alternative method of using <CTRL><ALT><+/-> keys to change the speed may be used if necessary.

IR Connector

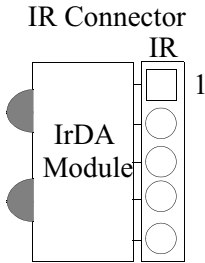

Pin Assignment

1. +5V
2. N. C.
3. IR Receiver
4. Ground
5. IR Transmitter

USB Connector

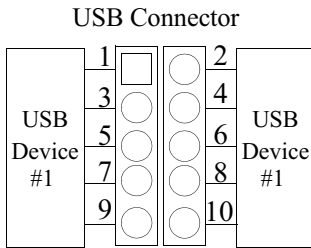

Pin Assignment

- | | |
|------------|------------|
| 1. +5V | 2. +5V |
| 3. USB D0- | 4. USB D1- |
| 5. USB D0+ | 6. USB D1+ |
| 7. Ground | 8. Ground |
| 9. Ground | 10. Ground |

I/O Port Connectors

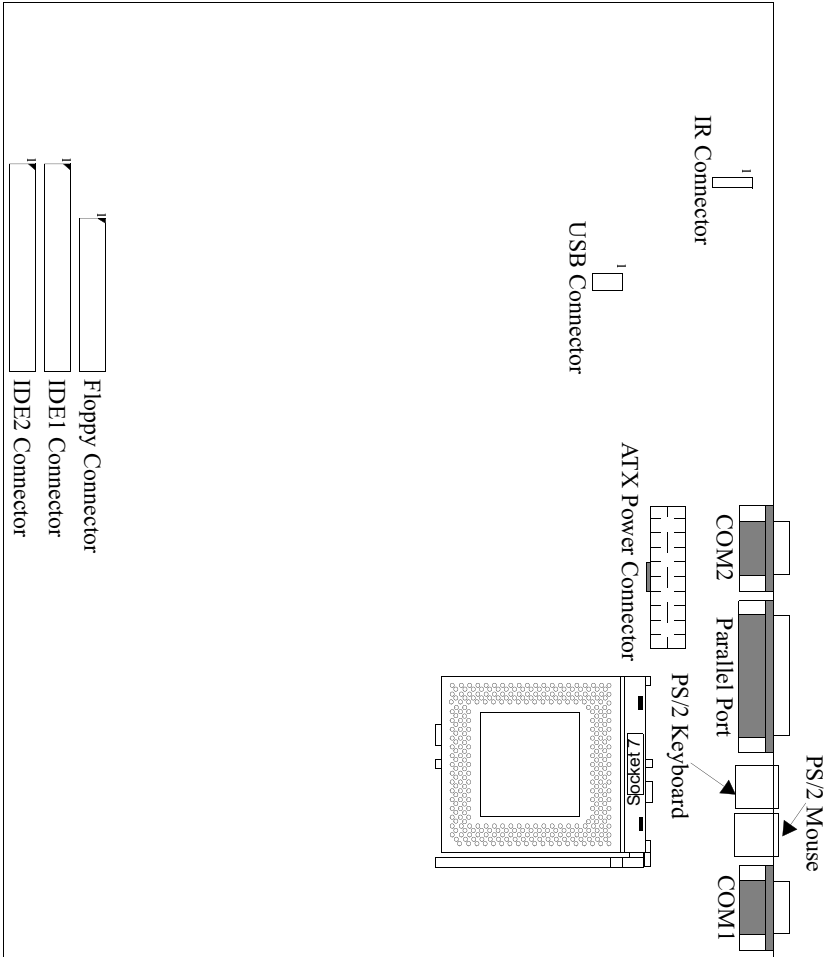

Caution!!

You must orient the cable connector so that the pin 1 (color) edge of the cable is at the pin 1 of the I/O port connector.

Use the following information to connect the floppy disk drives, IDE drives, and USB cable.

1. You must orient the cable connector so that the pin 1(color) edge of the cable is at the pin 1 of the I/O port connector.
2. A floppy disk drive ribbon cable has 34 wires and 2 connectors to support 2 floppy disk drives. The connector with twisted wires always connects to drive A, and the connector which does not have twisted wire connects to drive B.
3. An IDE drive ribbon cable has 40 wires and 2 connectors to support two IDE drives. If a ribbon cable connects to two IDE drives at the same time, one of them has to be configured as Master and the other one has to be configured as Slave by setting the drive select jumpers on the drive. Consult the documentation that comes with your IDE drive for details on jumper locations and settings.

Power Supply Connector

Incorrect installation of the power supply could result in serious damage to the mainboard and connected peripherals. Make sure the power supply is unplugged before connecting the leads from the power supply.

ATX Power Connector

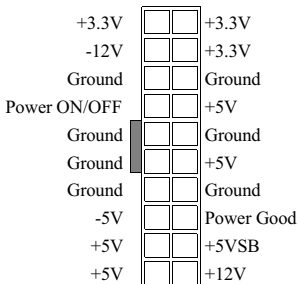

The ATX power supply has a single lead connector with a clip on one side of the plastic housing. There is only one way to plug the lead into the ATX power connector. However, make sure the clip faces toward the components, not the board's edge. Press the lead connector down until the clip snaps into place and secures the lead onto the connector.

2.2.3 Installing CPU

To avoid being broken by the pressure of CPU insertion, the main-board must be placed on a flat anti-static surface before the CPU is installed. Do not touch the CPU pins with your fingers during the installation.

1. Push the CPU ZIF socket's lever to the side a little and raise it as far as it can go.
2. Align the CPU with the ZIF Socket 7 so that the pin 1 (cut corner) of CPU is at the pin 1 of the Socket 7 as shown in the figure below, then insert the CPU into the socket.
3. Press the lever down to snap it into place at the side of socket.
You will feel some resistance as the pressure starts to secure the CPU in the socket.
4. Install a heatsink with a cooling fan that is required to protect the CPU from being damaged due to overheat.

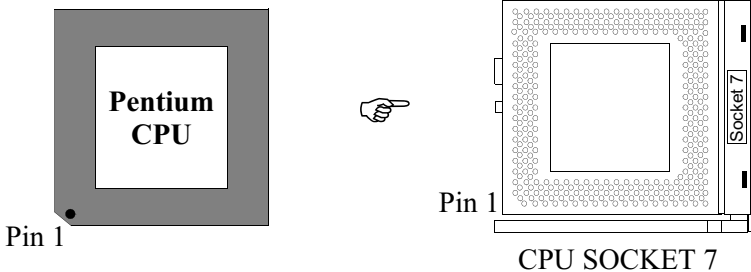

2.2.4 Tips for CPU Installation

1. Follow the instructions in section 2.2.3 to install the CPU onto the CPU socket.
2. Apply thermalloy (a piece of alloy + thermal grease) or thermal grease on top of the CPU Heat Spreader. Most heat sinks are not perfectly flat, the air gap need to be filled with an interface material that has a lower thermal resistance than air.
3. To enhance your system's reliability the orientation of the CPU's heatsink with fan shown below is strongly recommended. This orientation will increase air flow blowing toward the heatsink and help cooling down the voltage regulator.

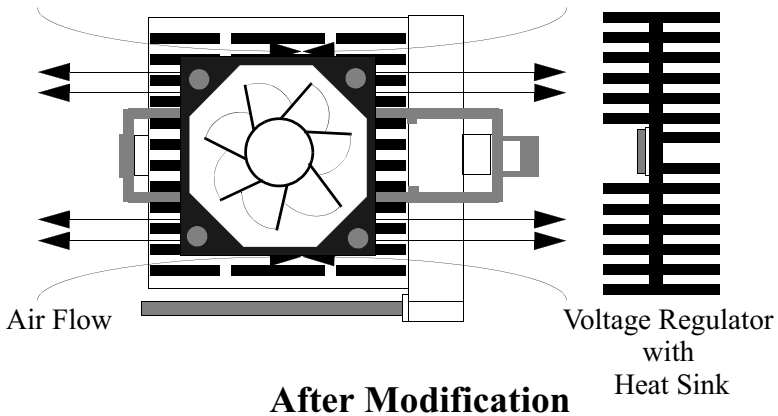

2.2.5 Installing System Memory

The P5F72 Mainboard has four SIMM Sockets and two DIMM Socket to support up to 128MB of system memory. The four SIMM sockets (SIMM1 ~ SIMM4) are divided into 2 Banks, Bank2 (SIMM1, SIMM2) and Bank3 (SIMM3, SIMM4).

Memory can be installed by using 72-pin EDO/FPM SIMM and/or 168-pin SDRAM DIMM memory modules. There are no jumper settings required for the memory size or type, which is automatically detected by the BIOS. Due to the P5F72 Mainboard high speed design, the memory modules for the P5F72 must meet all of the following requirements.

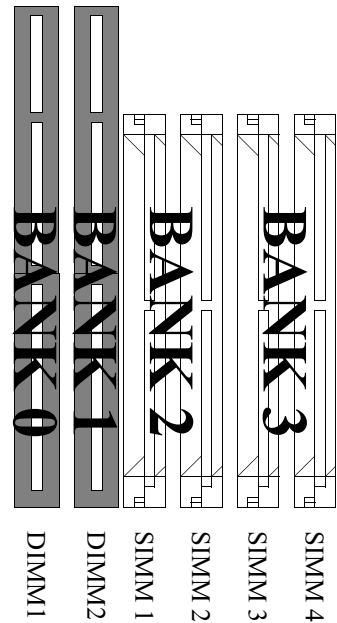

DRAM TYPE	EDO (Extended Data Output) FPM (Fast Page Mode)	SDRAM (Synchronous DRAM)
Module Size	Single-Sided Symmetric: 1Mx32, 4Mx32. Asymmetric: 512Kx32, 1Mx32, 2Mx32, 4Mx32. Double-Sided Symmetric: 2Mx32, 8Mx32. Asymmetric: 1Mx32, 2Mx32, 4Mx32, 8Mx32.	Single-sided Asymmetric: 1Mx64, 2Mx64, 4Mx64. Double-Sided Asymmetric: 2Mx64, 4Mx64, 8Mx64.
Requirements	DRAM Speed: 60ns or 70ns RAS Access Time : 60ns ~70ns CAS Access Time: 10ns ~20ns Two SIMM modules must be installed at a time, and each pair of modules must be the same size, type and speed.	3.3V unbuffered DIMM module Speed grade: 66.7MHz CAS latency: 3 or faster

72-Pin SIMM Module only Memory Configuration.

BANK 2 SIMM1, SIMM2	BANK 3 SIMM3, SIMM4	Total
1M x 32(4MB)	Empty	8MB
1M x 32(4MB)	1M x 32(4MB)	16MB
1M x 32(4MB)	2M x 32(8MB)	24MB
1M x 32(4MB)	4M x 32(16MB)	40MB
1M x 32(4MB)	8M x 32(32MB)	72MB
2M x 32(8MB)	Empty	16MB
2M x 32(8MB)	1M x 32(4MB)	24MB
2M x 32(8MB)	2M x 32(8MB)	32MB
2M x 32(8MB)	4M x 32(16MB)	48MB
2M x 32(8MB)	8M x 32(32MB)	80MB
4M x 32(16MB)	Empty	32MB
4M x 32(16MB)	1M x 32(4MB)	40MB
4M x 32(16MB)	2M x 32(8MB)	48MB
4M x 32(16MB)	4M x 32(16MB)	64MB
4M x 32(16MB)	8M x 32(32MB)	96MB
8M x 32(32MB)	Empty	64MB
8M x 32(32MB)	1M x 32(4MB)	72MB
8M x 32(32MB)	2M x 32(8MB)	80MB
8M x 32(32MB)	4M x 32(16MB)	96MB
8M x 32(32MB)	8M x 32(32MB)	128MB
Empty	1M x 32(4MB)	8MB
Empty	2M x 32(8MB)	16MB
Empty	4M x 32(16MB)	32MB
Empty	8M x 32(32MB)	64MB
Empty	16M x 32(64MB)	128MB

168-Pin DIMM Module only Memory Configuration.

BANK 0 (DIMM1)	BANK 1(DIMM2)	Total
1M x 64(8MB)	Empty	8MB
1M x 64(8MB)	1M x 64(8MB)	16MB
1M x 64(8MB)	2M x 64(16MB)	24MB
1M x 64(8MB)	4M x 64(32MB)	40MB
1M x 64(8MB)	8M x 64(64MB)	72MB
2M x 64(16MB)	Empty	16MB
2M x 64(16MB)	1M x 64(8MB)	24MB
2M x 64(16MB)	2M x 64(16MB)	32MB
2M x 64(16MB)	4M x 64(32MB)	48MB
2M x 64(16MB)	8M x 64(64MB)	80MB
4M x 64(32MB)	Empty	32MB
4M x 64(32MB)	1M x 64(8MB)	40MB
4M x 64(32MB)	2M x 64(16MB)	48MB
4M x 64(32MB)	4M x 64(32MB)	64MB
4M x 64(32MB)	8M x 64(64MB)	96MB
8M x 64(64MB)	Empty	64MB
8M x 64(64MB)	1M x 64(8MB)	72MB
8M x 64(64MB)	2M x 64(16MB)	80MB
8M x 64(64MB)	4M x 64(32MB)	96MB
8M x 64(64MB)	8M x 64(64MB)	128MB
Empty	1M x 64(8MB)	8MB
Empty	2M x 64(16MB)	16MB
Empty	4M x 64(32MB)	32MB
Empty	8M x 64(64MB)	64MB

168-Pin DIMM and 72 Pin SIMM Modules mix Memory Configuration..

BANK 0 (DIMM1)	BANK 1 (DIMM2)	BANK 2 SIMM1, 2	BANK3 SIMM3, 4	Total
1M x 64(8MB)	Empty	Empty	1M x 32(4MB)	16MB
1M x 64(8MB)	Empty	Empty	2M x 32(8MB)	24MB
1M x 64(8MB)	Empty	Empty	4M x 32(16MB)	40MB
1M x 64(8MB)	Empty	Empty	8M x 32(32MB)	72MB
2M x 64(16MB)	Empty	Empty	1M x 32(4MB)	24MB
2M x 64(16MB)	Empty	Empty	2M x 32(8MB)	32MB
2M x 64(16MB)	Empty	Empty	4M x 32(16MB)	48MB
2M x 64(16MB)	Empty	Empty	8M x 32(32MB)	80MB
4M x 64(32MB)	Empty	Empty	1M x 32(4MB)	40MB
4M x 64(32MB)	Empty	Empty	2M x 32(8MB)	48MB
4M x 64(32MB)	Empty	Empty	4M x 32(16MB)	64MB
4M x 64(32MB)	Empty	Empty	8M x 32(32MB)	96MB
8M x 64(64MB)	Empty	Empty	1M x 32(4MB)	72MB
8M x 64(64MB)	Empty	Empty	2M x 32(8MB)	80MB
8M x 64(64MB)	Empty	Empty	4M x 32(16MB)	96MB
8M x 64(64MB)	Empty	Empty	8M x 32(32MB)	128MB
Empty	1M x 64(8MB)	1M x 32(4MB)	Empty	16MB
Empty	1M x 64(8MB)	2M x 32(8MB)	Empty	24MB
Empty	1M x 64(8MB)	4M x 32(16MB)	Empty	40MB
Empty	1M x 64(8MB)	8M x 32(32MB)	Empty	72MB
Empty	2M x 64(16MB)	1M x 32(4MB)	Empty	24MB
Empty	2M x 64(16MB)	2M x 32(8MB)	Empty	32MB
Empty	2M x 64(16MB)	4M x 32(16MB)	Empty	48MB
Empty	2M x 64(16MB)	8M x 32(32MB)	Empty	80MB
Empty	4M x 64(32MB)	1M x 32(4MB)	Empty	40MB
Empty	4M x 64(32MB)	2M x 32(8MB)	Empty	48MB
Empty	4M x 64(32MB)	4M x 32(16MB)	Empty	64MB
Empty	4M x 64(32MB)	8M x 32(32MB)	Empty	96MB
Empty	8M x 64(64MB)	1M x 32(4MB)	Empty	72MB
Empty	8M x 64(64MB)	2M x 32(8MB)	Empty	80MB
Empty	8M x 64(64MB)	4M x 32(16MB)	Empty	96MB
Empty	8M x 64(64MB)	8M x 32(32MB)	Empty	128MB

The following SIMM/DIMM mix memory configuration is for users who can distinguish double-sided (two Row Address Strokes) memory module from single-sided (one Row Address Strobe) memory module.

BANK 0 (DIMM1)	BANK 1 (DIMM2)	BANK 2 SIMM1, 2	BANK3 SIMM3, 4
Single-Sided	Empty	Single-Sided	Empty
Single-Sided	Empty	Single-Sided	Single-Sided
Single-Sided	Empty	Single-Sided	Double-Sided
Single-Sided	Single-Sided	Empty	Single-Sided
Single-Sided	Single-Sided	Single-Sided	Empty
Single-Sided	Single-Sided	Single-Sided	Single-Sided
Single-Sided	Double-Sided	Single-Sided	Empty
Empty	Single-Sided	Empty	Single-Sided
Empty	Single-Sided	Single-Sided	Single-Sided
Empty	Single-Sided	Double-Sided	Single-Sided
Double-Sided	Empty	Empty	Single-Sided
Double-Sided	Empty	Empty	Double-Sided
Double-Sided	Single-Sided	Empty	Single-Sided
Empty	Double-Sided	Single-Sided	Empty
Empty	Double-Sided	Double-Sided	Empty

2.2.6 Clear CMOS and Password

If your system can not boot up because you forget your password, or the CMOS settings need to be reset to default values because the system BIOS is updated, the following instructions can be performed to clear the CMOS and password.

1. Power off the system
2. Place a shunt to short pin1 and pin2 of JP10 for 5 seconds
3. Remove the shunt
4. Power on the system

3 BIOS Configuration

After hardware configuration of P5F72 Mainboard is completed, and system hardware has been assembled, the completed system may be powered up. At this point, software setup should be run to ensure that system information is correct.

Normally, system setup is needed when the system hardware is not consistent with the information contained in the CMOS RAM, whenever the CMOS RAM has lost power, or the system features need to be changed.

3.1 Entering Setup

When the system is powered on, the BIOS will enter the Power-On Self Test (POST) routines. These routines perform various diagnostic checks at the time the system is powered up; if an error is encountered, the error will be reported in one of two different ways. If the error occurs before the display device is initialized, a series of beeps will be transmitted. If the error occurs after the display device is initialized, the screen will display the error message.

After the POST routines are completed, the following message appears:

“Press DEL to enter SETUP”

To access the AWARD BIOS SETUP program, press the key. The “CMOS SETUP UTILITY” screen will be displayed at this time.

3.2 CMOS SETUP UTILITY

Main Program Screen

ROM PCI/ISA BIOS (2A59GF2CC) CMOS SETUP UTILITY AWARD SOFTWARE, INC.	
STANDARD CMOS SETUP IDE HDD AUTO DETECTION LOAD SETUP DEFAULTS SAVE & EXIT SETUP EXIT WITHOUT SAVING HDD LOW LEVEL FORMAT	BIOS FEATURES SETUP CHIPSET FEATURES SETUP POWER MANAGEMENT SETUP PNP/PCI CONFIGURATION INTEGRATED PERIPHERALS SUPERVISOR PASSWORD USER PASSWORD
Esc: Quit F10: Save & Exit Setup	↑ ↓ → ← : Select Item <Shift>F2 : Change Color
Time, Date, Hard Disk Type...	

This screen provides access to the utility's various functions.

Listed below are explanations of the keys displayed at the bottom of the screen:

<ESC>: Exit the utility.

ARROW KEYS: Use arrow keys to move cursor to desired selection.

<F10>: Saves all changes made to Setup and exits program.

<Shift> <F2>: Changes background and foreground colors.

3.3 STANDARD CMOS SETUP

Selecting “STANDARD CMOS SETUP “on the main program screen displays this menu:

Standard CMOS Setup Screen

ROM PCI/ISA BIOS (2A59GF2CC) STANDARD CMOS SETUP AWARD SOFTWARE, INC.								
Date (mm:dd:yy): Tue, Apr 02 1996								
Time (hh:mm:ss): 10:10:10								
<u>HARD DISKS</u>	<u>TYPE</u>	<u>SIZE</u>	<u>CYLS</u>	<u>HEAD</u>	<u>PRECOMP</u>	<u>LANDZ</u>	<u>SECTOR</u>	<u>MODE</u>
Primary Master	: Auto	0	0	0	0	0	0	Auto
Primary Slave	: Auto	0	0	0	0	0	0	Auto
Secondary Master	: Auto	0	0	0	0	0	0	Auto
Secondary Slave	: Auto	0	0	0	0	0	0	Auto
Drive A: 1.44M, 3.5 in.								
Drive B: None								
Video: EGA/VGA						Base Memory: 640K		
Halt On: All Errors						Extended Memory: 15360K		
						Other Memory: 384K		
						Total Memory: 16384K		
ESC: Quit ↑ ↓ → ← : Select Item PU/PD/+/-: Modify								
F1: Help (Shift) F2 : Change Color								

The Standard CMOS Setup utility is used to configure the following features:

Set Date: Month, Date, Year.

Set Time: Hour, Minute, and Second. Use 24 Hour clock format (for PM numbers, add 12 to the hour, you would enter 4:30 p.m. As 16:30).

Hard Disks:

There are four hard disks listed: “Primary Master”, “Primary Slave”, “Secondary Master” and “Secondary Slave”. For Each

IDE channel, the first device is the “Master” and the second device is “Slave”.

Hard disk Types from 1 to 45 are standard ones; Type “Auto” is IDE HDD auto detection; Type “User” is user definable, and Type “None” is not installed (e.g. SCSI).

There are six categories of information you must enter for a HDD: “CYLS” (number of cylinders), “HEAD” (number of heads), “PRECOMP” (write pre-compensation), “LANDZ” (landing zone), “SECTOR” (number of sectors) and “MODE” (Normal, LBA, LARGE and AUTO). The hard disk vendor’s or system manufacturer’s documentation should provide you the information needed. For an IDE hard drive, you can set ‘TYPE’ to “Auto” or use the “IDE HDD AUTO DETECTION” utility in the main program screen to enter the drive specifications.

The AWARD BIOS supports three HDD modes: NORMAL, LBA and LARGE.

NORMAL mode: Generic access mode in which neither the BIOS nor the IDE controller will make any transformation during accessing. The maximum HDD size supported by the NORMAL mode is 528 Megabytes.

LBA mode: Logical Block Addressing mode is a HDD accessing method to overcome the 528Megabytes restriction. The number of cylinders, heads and sectors shown in setup may not be the number physically contained in the HDD.

During HDD accessing, the IDE controller will transform the logical address described by the cylinder, head and sector numbers into its own physical address inside the HDD. The maximum HDD size supported by the LBA mode is 8.4 Gigabytes.

LARGE mode: Some IDE HDD contains more than 1024 cylinders without LBA support. This access mode tricks DOS (or other OS) that the number of cylinders is less than 1024 by dividing it by 2. At the same time, number of heads is multiplied by 2.

A reverse transformation process will be made inside INT13h in order to accessing the right HDD address. The maximum HDD size supported by the LARGE mode is 1 Gigabytes.

Note: To support LBA or LARGE mode, there must be some software involved. All these software are located in the AWARD HDD Service Routine “INT13h”. It may fail to access a HDD with LBA or LARGE modes selected if you are running under an Operating System which replaces the whole INT13h service routine.

Floppy Drive A and Floppy Drive B: The options are: “360K, 5.25 in.”, “1.2M, 5.25in.”, “720K, 3.5in.”, “1.44M, 3.5in.”, “2.88M, 3.5in.” and “None (Not Installed)”. Not Installed could be used as an option for diskless workstations.

3.4 IDE HDD AUTO DETECTION

If your system has an IDE hard drive, you can use this utility to detect its parameters and enter them into the Standard CMOS Setup automatically.

If the auto-detected parameters displayed do not match the ones that should be used for your hard drive, do not accept them. Press the <N> key to reject the values and enter the correct ones manually on the Standard CMOS Setup screen.

Note: If you are setting up a new hard disk drive (nothing on it) that supports LBA mode, more than one line will appear in the parameter box, choose the line that lists LBA for an LBA drive.

Do not choose Large or Normal if the hard disk drive is already fully formatted when you install it, choose the mode which is used to format it.

3.5 LOAD SETUP DEFAULTS

“LOAD SETUP DEFAULTS” loads optimal settings which are stored in the BIOS ROM.

The defaults loaded only affect the BIOS Features Setup, Chipset Features Setup, Power Management Setup, PnP/PCI configuration setup and Integrated Peripherals Setup. There is no effect on the Standard CMOS Setup. To use this feature, highlight on the main screen and press <Enter>. A line will appear on the screen asking if you want to load the Setup default values. Press the <Y> key and then press the <Enter> key if you want to load the Setup defaults. Press <N> if you don't want to proceed.

3.6 SAVE & EXIT SETUP

Selecting this option and pressing the <Enter> key to save the new setting information in the CMOS memory and continue with the booting process.

3.7 EXIT WITHOUT SAVING

Selecting this option and pressing the <Enter> key to exit the Setup Utility without recording any new values or changing old ones.

3.8 HDD LOW LEVEL FORMAT

Selecting this option and pressing the <Enter> key enable you to perform low level format of hard disk drive.

3.9 BIOS FEATURES SETUP

Selecting “BIOS FEATURES SETUP” on the main program screen displays this menu:

BIOS Features Setup Screen

ROM PCI/ISA BIOS (2A59GF2CC) BIOS FEATURES SETUP AWARD SOFTWARE, INC.			
Virus Warning	: Disabled	Video BIOS Shadow	: Enabled
CPU Internal Cache	: Enabled	C8000 - CBFFF Shadow	: Disabled
External Cache	: Enabled	CC000 - CFFFF Shadow	: Disabled
Quick Power On Self Test	: Disabled	D0000 - D3FFF Shadow	: Disabled
Boot Sequence	: C, A, SCSI	D4000 - D7FFF Shadow	: Disabled
Swap Floppy Drive	: Disabled	D8000 - DBFFF Shadow	: Disabled
Boot Up Floppy Seek	: Enabled	DC000 - DFFFF Shadow	: Disabled
Boot Up NumLock Status	: On	PS/2 mouse function control	: Disabled
Gate A20 Option	: Fast	OS Select for DRAM > 64MB	: Non-OS2
Typematic Rate Setting	: Disabled	ESC: Quit ↑ ↓ → ← :Select Item F1: Help PU/PD/+/-:Modify F5: Old Values (Shift) F2: Color F6: Load BIOS Defaults F7: Load Setup Defaults	
Typematic Rate (Chars/Sec)	: 6		
Typematic Delay (Msec)	: 250		
Security Option	: Setup		
PCI/VGA Palette Snoop	: Disabled		

The following explains the options for each features:

Virus Warning: The Virus Warning’s default setting is “Disabled”. When enabled, any attempt to write the boot sector and partition table will halt the system and cause a warning message to appear. If this happens, you can use an anti-virus utility on a virus free, bootable floppy diskette to reboot and clean your system.

CPU Internal Cache: The default setting is “Enabled”. This Setting enables the CPU internal cache.

External Cache: The default setting is “Enabled”. This setting enables the external cache.

Quick Power On Self Test: The default setting is “Disabled”. If enabled, this will skip some diagnostic checks during the Power On Self Test (POST) to speed up booting process.

Boot Sequence: The default setting is “C, A, SCSI”; the other options are “CDROM, C, A” and “C, CDROM, A”. The BIOS will load the operating system from the disk drives in the sequence selected here.

Swap Floppy Drive: The default setting is “Disabled”. This setting gives you an option to swap A and B floppy disks. Normally the floppy drive A is the one at the end of the cable, if you set this option to “Enabled”, the drive at the end of the cable will be swapped to B.

Boot Up Floppy Seek: The default setting is “Enabled”. When enabled, the BIOS will check whether there is a floppy disk drive installed.

Boot Up Numlock Status: The default setting is “On”. If set “Off”, the cursor controls will function on the numeric keypad.

Gate A20 Option: the default setting is “Fast”. This is the optimal setting for the Mainboard. The other option is “Normal”.

Typematic Rate Setting: The default setting is “Disabled”. If enabled, you can set the typematic Rate and typematic Delay.

Typematic Rate (Chars/Sec): This setting controls the speed at which the system registers repeated keystrokes. The choices range from 6 to 30 Chars/Sec. The default setting is “6” Chars/Sec.

Typematic Delay (Msec): This setting controls the time between the display of the first and second characters. There are four delay choices: 250ms, 500ms, 750ms and 1000ms. The default setting is “250” ms.

Security Option: This setting controls the password feature. The options are “Setup” and “System”. Select “Setup” will protect the configuration settings from being tampered with. Select “System” if you want to use password feature every time the system boots up. The default setting is “Setup”. You can create your password by using the “SUPERVISOR/USER PASSWORD” utility on the main program screen.

PCI/VGA Palette Snoop: The default setting is “Disabled”. Set to “Enable” if any ISA adapter card installed requires VGA palette snooping.

Video BIOS Shadow: The default setting is “Enabled” which will copy the VGA BIOS into system DRAM.

C8000-CBFFF Shadow to DC000-DFFFF Shadow: The default setting for the shadow feature is “Disabled”. When enabled, the ROM with the specific address is copied into system DRAM. It will also reduce the size of memory available to the system.

PS/2 mouse function control: The Default setting is “Disabled”. Set to “Enabled” when a PS/2 mouse is attached to the system and used as an input device.

OS Select For DRAM > 64MB:The default setting is “Non-OS2”. Set to “OS2” if the system memory size is greater than 64MB and the operating system is OS/2.

After you have made your selection in the BIOS FEATURES SETUP, press the <ESC> key to go back to the main program screen.

3.10 CHIPSET FEATURES SETUP

Selecting “CHIPSET FEATURES SETUP” on the main program screen displays this menu:

Chipset Features Setup Screen

ROM PCI/ISA BIOS (2A59GF2CC) CHIPSET FEATURES SETUP AWARD SOFTWARE, INC.			
Auto Configuration	: Enabled	Memory Hole At 15M-16M	: Disabled
DRAM Timing	: 70 ns	Peer Concurrency	: Enabled
DRAM RAS# Precharge Time	: 4	Passive Release	: Enabled
DRAM R/W Leadoff Timing	: 6	Delayed Transaction	: Disabled
Fast RAS To Cas Delay	: 3		
DRAM Read Burst (EDO/FP)	: x333/x444		
DRAM Write Burst Timing	: x333		
Fast MA to RAS# Delay Clk	: 1		
Fast EDO Path Select	: Disabled		
Refresh RAS# Assertion	: 5 Clks		
ISA Bus Clock	: PCICLK/4		
SDRAM (CAS Lat/RAS-to-CAS)	: 3/3		
System BIOS Cacheable	: Disabled	ESC: Quit	↑ ↓ → ← :Select Item
Video BIOS Cacheable	: Enabled	F1: Help	PU/PD/+/-:Modify
8 Bit I/O Recovery Time	: 3	F5: Old Values	(Shift) F2: Color
16 Bit I/O Recovery Time	: 3	F6: Load BIOS Defaults	
		F7: Load Setup Defaults	

This screen controls the settings for the board’s chipset. All the entries related to the DRAM timing and ISA clock on the screen are automatically configured. Do not make any change unless you are familiar with the chipset.

Auto Configuration: The default setting is “Enabled” which will set optimal DRAM timing automatically depending on whether the DRAM used is 70ns or 60ns. The other option is “Disabled” which allows you to change DRAM timing manually.

DRAM Timing: Choose DRAM speed 60ns or 70ns.

Memory Hole At 15M-16M: The default setting is “Disabled”. Set to “Enabled” means that when the system memory size is equal to

or greater than 16M bytes, the physical memory address from 15M to 16M will be passed to PCI or ISA and there will be 1MBytes hole in your system memory. This option is designed for some OS with special add-in cards which need 15M-16M memory space.

Peer Concurrency: The default setting is “Enabled” which allows CPU to run DRAM/External Cache cycles when PCI masters are running cycles targeting PCI peer devices. The other option is “Disabled”.

Passive Release, Delayed Transaction: To enable PCI Concurrency, these two options have to be set to “Enabled”.

After you have made your selections in the CHIPSET FEATURES SETUP, press the <ESC> key to go back to the main program screen.

3.11 POWER MANAGEMENT SETUP

Power Management Setup Screen

ROM PCI/ISA BIOS (2A59GF2CC) POWER MANAGEMENT SETUP AWARD SOFTWARE, INC.	
Power Management	: Disable
PM Control by APM	: No
Video Off Method	: V/H SYNC+Blank
Doze Mode	: Disable
Standby Mode	: Disable
Suspend Mode	: Disable
HDD Power Down	: Disable
** Wake Up Events **	
IRQ3 (Wake-Up Event)	: OFF
IRQ4 (Wake-Up Event)	: OFF
IRQ8 (Wake-Up Event)	: OFF
IRQ12(Wake-Up Event)	: OFF
** Power Down / Resume Events **	
IRQ3 (COM 2)	: OFF
IRQ4 (COM 1)	: OFF
IRQ5 (LPT 2)	: OFF
IRQ6 (Floppy Disk)	: OFF
IRQ7 (LPT 1)	: OFF
IRQ8 (RTC Alarm)	: OFF
IRQ9 (IRQ2 Redir)	: OFF
IRQ10 (Reserved)	: OFF
IRQ11 (Reserved)	: OFF
IRQ12 (PS/2 Mouse)	: OFF
IRQ13 (Coprocessor)	: OFF
IRQ14 (Hard Disk)	: OFF
IRQ15 (Reserved)	: OFF
ESC: Quit ↑ ↓ → ← :Select Item F1: Help PU/PD/+/-:Modify F5: Old Values (Shift) F2: Color F6: Load BIOS Defaults F7: Load Setup Defaults	

The “Power Management Setup” controls the mainboard’s “Green” features.

Selecting “POWER MANAGEMENT SETUP” on the main program screen displays this menu:

Power Management: This setting controls the System Doze Mode, Standby Mode and Suspend Mode Timer features. There are four options:

User Define: Allows you to customize all power saving timer features.

Optimize: This is the recommended setting for general use.

Test/Demo: This is for test/demonstration purpose.

Disable: Disable the power management features.

PM Control by APM: The default setting is “No”. If set to “Yes”, system BIOS will wait for APM’s prompt before it enters any PM mode.

Note: If your system power management is controlled by APM and there is a task running, the APM will not prompt the BIOS to enter any power saving mode after time out.

Video Off Method: This setting controls the Video off method in power saving mode. The default setting is “V/H SYNC+Blank”. This setting disables V/H SYNC signals and blanks the screen in power saving mode. Other options are “Blank Screen” and “DPMS”.

Doze Mode: Options are from “1 Min” to “1 Hour” and “Disable”. The system speed will change from turbo to slow if no Power Management events occur for a specified length of time. Full power function will return when a Wake-Up event is detected.

Standby Mode: Options are from “1 Min” to “1 Hour” and “Disable”. The system speed will change from turbo to slow and the video signal will be suspended if no Power Management events occur for a specified length of time. Full power function will return when a Wake-Up event is detected.

Suspend Mode: Options are from “1 Min” to “1 Hour” and “Disable”. The CPU clock will be stopped and the video signal will be suspended if no Power Management events occur for a specified length of time. Full power function will return when a Wake-Up event is detected.

HDD Power Down: Options are from “1 Min” to “15 Min” and “Disable”. The IDE hard drive will spin down if it is not accessed within a specified length of time.

Wake-Up Events: When a hardware event is enabled, the occurrence of a corresponding event will return the system to full speed.

Power Down / Resume Events: when a hardware event is enabled, the occurrence of a corresponding event will prevent the system from entering any PM mode.

After you have made your selection in the POWER MANAGEMENT SETUP, press the <ESC> key to go back to the main program screen.

3.12 PNP / PCI CONFIGURATION

Both the ISA and PCI buses on the Mainboard use system IRQs & DMAs. You must set up the IRQ and DMA assignments correctly thru the PnP/PCI Configuration Setup utility, otherwise the Mainboard will not work properly.

Selecting “PNP / PCI CONFIGURATION” on the main program screen displays this menu:

PNP / PCI Configuration

ROM PCI/ISA BIOS (2A59GF2CC)			
PNP / PCI CONFIGURATION			
AWARD SOFTWARE, INC.			
Resources Controlled By	: Manual	PCI IRQ Activated By	: Level
Reset Configuration Data	: Disabled	PCI IDE IRQ Map To	: PCI - AUTO
		Primary IDE INT#	: A
		Secondary IDE INT#	: B
IRQ-3 assigned to	: Legacy ISA		
IRQ-4 assigned to	: Legacy ISA		
IRQ-5 assigned to	: PCI / ISA PnP		
IRQ-7 assigned to	: Legacy ISA		
IRQ-9 assigned to	: PCI / ISA PnP		
IRQ-10 assigned to	: PCI / ISA PnP		
IRQ-11 assigned to	: PCI / ISA PnP		
IRQ-12 assigned to	: PCI / ISA PnP		
IRQ-14 assigned to	: Legacy ISA		
IRQ-15 assigned to	: Legacy ISA		
DMA-0 assigned to	: PCI / ISA PnP		
DMA-1 assigned to	: PCI / ISA PnP		
DMA-3 assigned to	: PCI / ISA PnP		
DMA-5 assigned to	: PCI / ISA PnP		
DMA-6 assigned to	: PCI / ISA PnP		
DMA-7 assigned to	: PCI / ISA PnP		
		ESC: Quit	↑ ↓ → ← :Select Item
		F1: Help	PU/PD/+/-:Modify
		F5: Old Values	(Shift) F2: Color
		F6: Load BIOS Defaults	
		F7: Load Setup Defaults	

Resources Controlled By: The defaults setting is “Auto” which will control all IRQs and DMAs automatically. The other option is “Manual” which allows you to control IRQs and DMAs individually.

Reset Configuration Data: The default setting is “Disabled”. When set to “Enabled”, The content of the ESCD block in flash BIOS will be cleared.

IRQ and DMA Assigned to.: If there is a legacy ISA device which uses an IRQ or a DMA, set the corresponding IRQ or DMA to “Legacy ISA”, otherwise you should set to PCI/ISA PnP.

PCI IRQ Activated By: Options are “Level” or “Edge”. The default setting is “Level”. This option is used to select the IRQ’s trigger method.

PCI IDE IRQ Map To, Primary IDE INT#, Secondary IDE INT#: If you disable onboard PCI IDE controller and install a PCI IDE card on the Mainboard, you need to set this option. If a PCI IDE Card which uses ISA IRQ directly thru a paddle card installed on an ISA slot, select “ISA” for the option “PCI IDE IRQ Map To”. If a PCI IDE Card uses PCI “INT” and is compliant to PCI Plug and Play specification, select “PCI-AUTO” for the option “PCI IDE IRQ Map To”. Otherwise select “PCI-SLOT n” (PCI-SLOT 1, PCI-SLOT 2 or PCI-SLOT 3) depends on which slot the PCI IDE Card is installed.

Only INT A and INT B are available for a PCI IDE Card, therefore you must set the PCI IDE Card’s primary interrupt to INT A and secondary interrupt to INT B. The INT A is routed to IRQ 14 and the INT B is routed to IRQ 15 thru a hardware router in the chipset.

3.13 INTEGRATED PERIPHERALS

Selecting “INTEGRATED PERIPHERALS” on the main program screen displays this menu

Integrated Peripheral Screen

ROM PCI/ISA BIOS (2A59GF2CC) INTEGRATED PERIPHERALS AWARD SOFTWARE, INC.	
IDE HDD Block Mode	: Enabled
PCI Slot IDE 2nd Channel	: Enabled
On-Chip Primary PCI IDE	: Enabled
On-Chip Secondary PCI IDE	: Enabled
IDE Primary Master PIO	: Auto
IDE Primary Slave PIO	: Auto
IDE Secondary Master PIO	: Auto
IDE Secondary Slave PIO	: Auto
Onboard FDD Controller	: Enabled
Onboard Serial Port 1	: 3F8 / IRQ 4
Onboard Serial Port 2	: 2F8 / IRQ 3
UART 2 Mode	: Normal
Onboard Parallel Port	: 378 / IRQ7
Onboard Parallel Mode	: Normal
USB Controller	: Disabled
ESC: Quit ↑ ↓ → ← :Select Item F1: Help PU/PD/+/-:Modify F5: Old Values (Shift) F2: Color F6: Load BIOS Defaults F7: Load Setup Defaults	

IDE HDD Block Mode: The Default setting is “Enabled”. This feature enhances hard disk performance by making multi-sector transfers instead of one sector per transfer. Most IDE drives, except very early design, have Block Mode transfer feature.

PCI Slot IDE 2nd Channel

The default setting is “Enabled”. This option enables the Secondary PCI IDE controller of the PCI IDE adapter.

On-Chip Primary/Secondary PCI IDE: The default setting is “Enabled”. This option enables the onboard Primary / Secondary PCI IDE controller.

IDE Primary Master PIO, IDE Primary Slave PIO, IDE Secondary Master PIO, IDE Secondary Slave PIO: There are six options “Auto”, “Mode 0”, “Mode 1”, “Mode 2”, “Mode 3” and “Mode 4”. The default setting is “Auto”. When set to “Auto” the BIOS will automatically set the mode to match the transfer rate of hard disk. If the system won’t boot up when set to “Auto”, set it manually to the lower mode. (e.g. From Mode 3 to Mode 2). All IDE drives should work with PIO mode 0.

Onboard FDD Controller: The default setting is “Enabled”. This option enables the onboard FDD controller.

Onboard Serial Port 1 and Onboard Serial Port 2: These options are used to assign the I/O addresses for the two onboard serial ports. They can be assigned as follows:

- 3F8/ IRQ4 (Serial Port 1 default)
- 2F8/ IRQ3 (Serial Port 2 default)
- 3E8/ IRQ4
- 2E8/ IRQ3
- Auto
- Disabled (Disable the onboard serial port)

UART 2 Mode: Set this feature to IrDA, if an IrDA infrared module is used in the system.

Onboard Parallel Port: This option is used to assign the I/O address for the onboard parallel port. The options are “378/IRQ7” (defaults), “278/IRQ7”, “3BC/IRQ7” and “Disabled” (disable the onboard parallel port). Note: Printer port always use IRQ7 when set “378/IRQ7” or “278/IRQ7” or “3BC/IRQ7” to “Enabled”.

Onboard Parallel Mode: There are four options “Normal” (default), “ECP”, “ECP/EPP” and “EPP/SPP”. Change the mode from “Normal” to the enhanced mode only if your peripheral device can support it.

ECP Mode Use DMA: When on-board parallel port set to ECP mode, the parallel port has option to use DMA “3”(default) or “1”.

USB Controller: To activate the Universal Serial Bus function, this feature has to be set to “Enabled”.

If you make any change for onboard FDD controller, serial ports or parallel port in this setup, save the change and turn off the system. After turning system on again the change will be effective.

3.14 SUPERVISOR / USER PASSWORD

The “SUPERVISOR/USER PASSWORD” utility sets the password. The Mainboard is shipped with the password disabled. If you want to change the password, you must first enter the current password, then at the prompt enter your new password. The password is case sensitive and you can use up to 8 alphanumeric characters, press <Enter> after entering the password. At the next prompt, confirm the new password by typing it and pressing <Enter> again.

To disable the password, press the <Enter> key instead of entering a new password when the “Enter Password” dialog box appears. A message will appear confirming that the password is disabled.

If you have set both supervisor and user password, only the supervisor password allows you to enter the BIOS SETUP PROGRAM.

Note:

If you forget your password, the only way to solve this problem is to discharge the CMOS memory by turning power off and placing a shunt on the JP17 to short pin 1 and pin 2 for 5 seconds, then removing the shunt.

4 Driver and Utility

4.1 Flash Utility

The BIOS of the P5F72 mainboard can be upgraded by using a Flash utility. A new version of the BIOS can be downloaded from the factory's BBS and Web site. The system BIOS is stored in a 1M-bit Flash EEPROM which can be erased and reprogrammed by the Flash utility.

There is a self-extracting archives file AWDFLASH.EXE. Execute the AWDFLASH.EXE to extract the following files.

FLASH.EXE	The Flash utility for AWARD BIOS upgrade.
README.TXT	A text file of instructions

The Flash utility will not work with any memory manager software running in the system. In order to make sure no memory manager software is running, boot your system from a bootable floppy disk which does not contain CONFIG.SYS nor AUTOEXEC.BAT files. If you are using MS-DOS 6.x, you can press <F5> function key while the "Starting MS-DOS..." appears on the screen to bypass the CONFIG.SYS and AUTOEXEC.BAT.

4.2 EIDE Bus Master Driver

The Bus Master EIDE logic designed in the Intel 82430VX chipset is intended to reduce the workload of the CPU and make the CPU running more efficiently. It will take care the data transfer between IDE drives and system memory and let CPU handle other tasks. In order to make the EIDE drive operate at bus-mastering DMA mode 2, the driver must be loaded properly.

There is a self-extracting archives file BMEIDE.EXE in the factory's BBS and Web site. Consult your vendor for the factory's BBS phone number and Web site address. Execute the BMEIDE.EXE to extract the following files.

BMIDE_95.EXE	Windows 95 archives
BMIDE_NT.EXE	Windows NT achieve
BMIDEOS2.EXE	OS/2 archives
README.TXT	A text file of instructions
LICENSE.TXT	A text file of license

4.3 Soft Off Control

When used with an ATX power supply, the P5F72 mainboard can turn off the system power via software control. The system BIOS will turn the system power off when it receives the proper APM command from the Operating System. For example, Windows 95 will issue this Soft Off APM command when the user selects "Shutdown the computer" option. In order for the Soft Off feature to work correctly, Power Management/APM must be enabled in the system BIOS and Operating System.

To enhance your system's reliability the orientation of the CPU's heatsink with fan shown below is strongly recommended. This orientation will increase air flow blowing toward the heatsink and help cooling down the voltage regulator.

