

Simple, Miniature Single-Cell, Fully Integrated Li-Ion / Li-Polymer Charge Management Controllers

Features

- Complete Linear Charge Management Controller
 - Integrated Pass Transistor
 - Integrated Current Sense
 - Integrated Reverse Discharge Protection
- Constant Current / Constant Voltage Operation with Thermal Regulation
- High Accuracy Preset Voltage Regulation: $\pm 1\%$
- Voltage Regulation: 4.20V
- Selectable Charge Current:
 - MCP73811: 85 mA / 450 mA
- Programmable Charge Current:
 - MCP73812: 50 mA - 500 mA
- Minimum External Components Required:
 - MCP73811: 2 Ceramic Capacitors
 - MCP73812: 2 Ceramic Capacitors and 1 Resistor
- No Preconditioning
- External End-of-Charge Control
- Automatic Power-Down when Input Power Removed
- Active High Charge Enable
- Temperature Range:
 - -40°C to $+85^{\circ}\text{C}$
- Packaging:
 - 5-Lead SOT-23

Applications

- Low-Cost Lithium-Ion/Lithium-Polymer Battery Chargers
- Rechargeable Toys
- Electronic Cigarettes
- Bluetooth Headsets
- USB Chargers

Description

The MCP73811/2 devices are linear charge management controllers that are designed for use in space limited and cost sensitive applications. The MCP73811/2 provide specific charge algorithms for single cell Li-Ion or Li-Polymer battery to achieve optimal capacity in the shortest charging time possible. Along with its small physical size, the low number of external components required make the MCP73811/2 ideally suited for portable applications. For applications charging from a USB port, the MCP73811 adheres to all the specifications governing the USB power bus.

The MCP73811/2 employ a constant current/constant voltage charge algorithm. The constant voltage regulation is fixed at 4.20V, with a tight regulation tolerance of 1%. For the MCP73811, the constant current value is selected as 85 mA (low power USB port) or 450 mA (high power USB port) with a digital input signal on the PROG input. For the MCP73812, the constant current value is set with one external resistor. The MCP73811/2 limit the charge current based on die temperature during high power or high ambient conditions. This thermal regulation optimizes the charge cycle time while maintaining device reliability.

The MCP73811/2 are fully specified over the ambient temperature range of -40°C to $+85^{\circ}\text{C}$. The MCP73811/2 are available in a 5-Lead, SOT-23 package.

Package Types

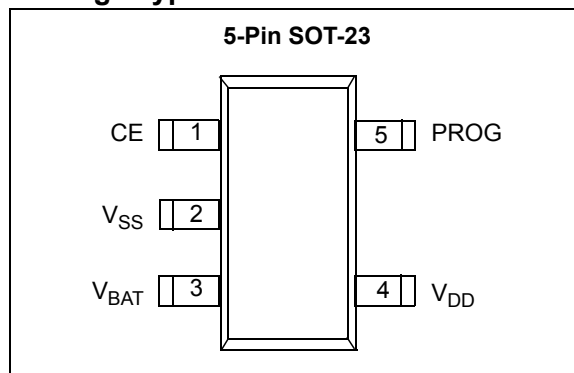

MCP73811/2

Typical Applications

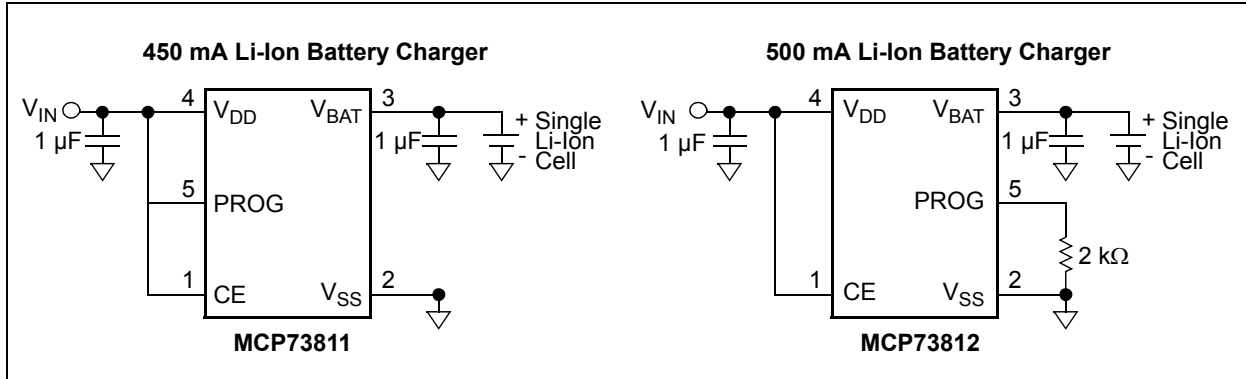

Functional Block Diagram

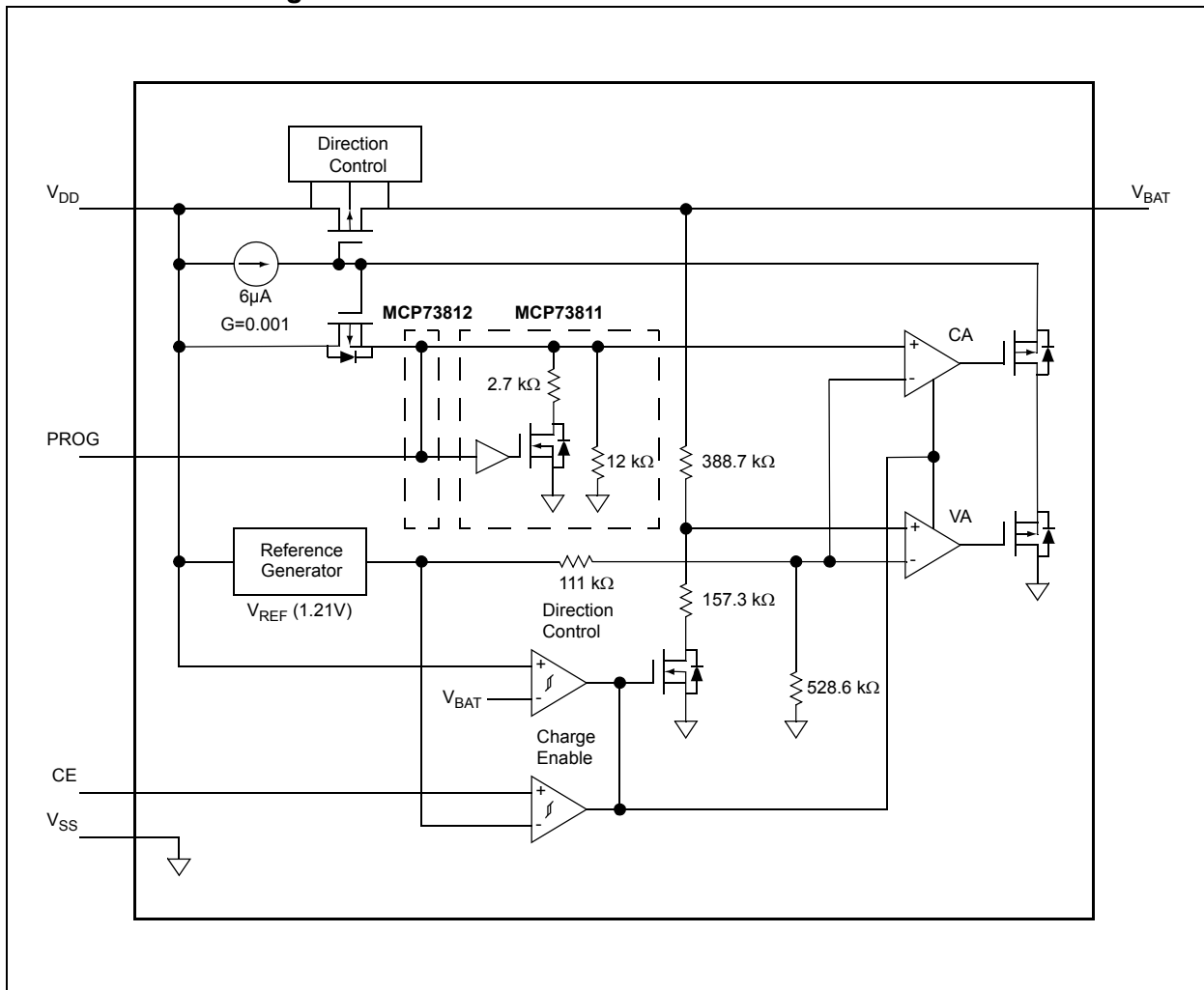

1.0 ELECTRICAL CHARACTERISTICS

Absolute Maximum Ratings†

V_{DDN} 7.0V
 All Inputs and Outputs w.r.t. V_{SS} -0.3 to ($V_{DD}+0.3$)V

Maximum Junction Temperature, T_J Internally Limited
 Storage temperature -65°C to +150°C
 ESD protection on all pins
 Human Body Model (1.5 kW in Series with 100 pF) ≥ 4 kV
 Machine Model (200pF, No Series Resistance) 400V

† **Notice:** Stresses above those listed under “Maximum Ratings” may cause permanent damage to the device. This is a stress rating only and functional operation of the device at those or any other conditions above those indicated in the operational listings of this specification is not implied. Exposure to maximum rating conditions for extended periods may affect device reliability.

DC CHARACTERISTICS

Electrical Specifications: Unless otherwise indicated, all limits apply for $V_{DD} = [V_{REG}(typ.) + 0.3V]$ to 6V, $T_A = -40^\circ C$ to $+85^\circ C$. Typical values are at $+25^\circ C$, $V_{DD} = [V_{REG}(typ.) + 1.0V]$						
Parameters	Sym	Min	Typ	Max	Units	Conditions
Supply Input						
Supply Voltage	V_{DD}	3.75	—	6	V	
Supply Current	I_{SS}	—	1000	1500	μA	Charging
		—	50	100	μA	Standby ($CE = V_{SS}$)
		—	1.2	5	μA	Shutdown ($V_{DD} \leq V_{BAT} - 100$ mV)
Voltage Regulation (Constant Voltage Mode)						
Regulated Output Voltage	V_{REG}	—	4.20	—	V	$V_{DD} = [V_{REG}(Typ) + 1V]$ $I_{OUT} = 10$ mA
Output Voltage Tolerance	V_{RTOL}	-1	—	+1	%	$T_A = -5^\circ C$ to $+55^\circ C$
Line Regulation	$ \frac{\Delta V_{BAT}/V_{BAT}}{\Delta V_{DD}} $	—	0.09	0.30	%/V	$V_{DD} = [V_{REG}(Typ) + 1V]$ to 6V $I_{OUT} = 10$ mA
Load Regulation	$ \frac{\Delta V_{BAT}/V_{BAT}}{\Delta I_{OUT}} $	—	0.09	0.30	%	$I_{OUT} = 10$ mA to 50 mA $V_{DD} = [V_{REG}(Typ) + 1V]$
Supply Ripple Attenuation	PSRR	—	52	—	dB	$I_{OUT} = 10$ mA, 10 Hz to 1 kHz
		—	47	—	dB	$I_{OUT} = 10$ mA, 10 Hz to 10 kHz
		—	22	—	dB	$I_{OUT} = 10$ mA, 10 Hz to 1 MHz
Current Regulation (Fast Charge Constant-Current Mode)						
Fast Charge Current Regulation	I_{REG}	—	85	—	mA	MCP73811 - PROG = Low
		—	450	—	mA	MCP73811 - PROG = High
		—	50	—	mA	MCP73812 - PROG = 20 k Ω
		—	100	—	mA	MCP73812 - PROG = 10 k Ω
		—	500	—	mA	MCP73812 - PROG = 2 k Ω
Charge Current Tolerance	I_{RTOL}	-10	—	+10	%	$T_A = -5^\circ C$ to $+55^\circ C$
Pass Transistor ON-Resistance						
ON-Resistance	R_{DSON}	—	400	—	m Ω	$V_{DD} = 3.75V$, $T_J = 105^\circ C$
Battery Discharge Current						
Output Reverse Leakage Current	$I_{DISCHARGE}$	—	0.5	2	μA	Shutdown ($V_{DD} \leq V_{BAT} - 100$ mV)

MCP73811/2

DC CHARACTERISTICS (Continued)

Electrical Specifications: Unless otherwise indicated, all limits apply for $V_{DD} = [V_{REG}(typ.) + 0.3V]$ to 6V, $T_A = -40^{\circ}C$ to $+85^{\circ}C$. Typical values are at $+25^{\circ}C$, $V_{DD} = [V_{REG}(typ.) + 1.0V]$						
Parameters	Sym	Min	Typ	Max	Units	Conditions
Charge Enable (CE), PROG Input - MCP73811						
Input High Voltage Level	V_{IH}	2	—	—	V	
Input Low Voltage Level	V_{IL}	—	—	0.8	V	
Input Leakage Current	I_{LK}	—	0.01	1	μA	$V_{CE} = V_{DD}$, $V_{PROG} = V_{DD}$
PROG Input - MCP73812						
Charge Impedance Range	R_{PROG}	2	—	20	$k\Omega$	MCP73812
Automatic Power Down (Direction Control)						
Automatic Power Down Entry Threshold	V_{PD}	$V_{BAT} + 10\text{ mV}$	$V_{BAT} + 50\text{ mV}$	—	V	$2.3V \leq V_{BAT} \leq V_{REG}$ V_{DD} Falling
Automatic Power Down Exit Threshold	V_{PDEXIT}	—	$V_{BAT} + 150\text{ mV}$	$V_{BAT} + 250\text{ mV}$	V	$2.3V \leq V_{BAT} \leq V_{REG}$ V_{DD} Rising
Thermal Shutdown						
Die Temperature	T_{SD}	—	150	—	$^{\circ}C$	
Die Temperature Hysteresis	T_{SDHYS}	—	10	—	$^{\circ}C$	

TEMPERATURE SPECIFICATIONS

Electrical Specifications: Unless otherwise indicated, all limits apply for $V_{DD} = [V_{REG}(typ.) + 0.3V]$ to 6V. Typical values are at $+25^{\circ}C$, $V_{DD} = [V_{REG}(typ.) + 1.0V]$						
Parameters	Sym	Min	Typ	Max	Units	Conditions
Temperature Ranges						
Specified Temperature Range	T_A	-40	—	+85	$^{\circ}C$	
Operating Temperature Range	T_J	-40	—	+125	$^{\circ}C$	
Storage Temperature Range	T_A	-65	—	+150	$^{\circ}C$	
Thermal Package Resistances						
Thermal Resistance, 5-Lead, SOT-23	θ_{JA}	—	230	—	$^{\circ}C/W$	4-Layer JC51-7 Standard Board, Natural Convection

2.0 TYPICAL PERFORMANCE CURVES

Note: The graphs and tables provided following this note are a statistical summary based on a limited number of samples and are provided for informational purposes only. The performance characteristics listed herein are not tested or guaranteed. In some graphs or tables, the data presented may be outside the specified operating range (e.g., outside specified power supply range) and therefore outside the warranted range.

Note: Unless otherwise indicated, $V_{DD} = [V_{REG}(typ.) + 1V]$, $I_{OUT} = 10\text{ mA}$ and $T_A = +25^\circ\text{C}$, Constant-voltage mode.

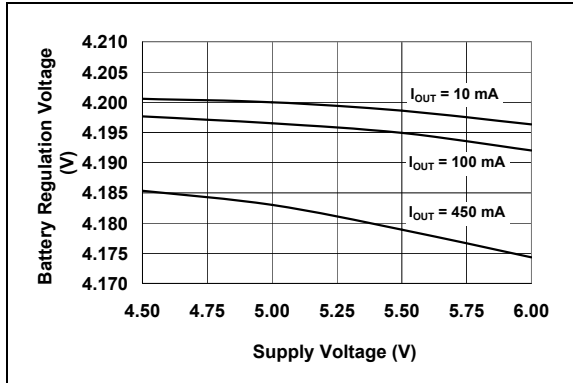

FIGURE 2-1: Battery Regulation Voltage (V_{BAT}) vs. Supply Voltage (V_{DD}).

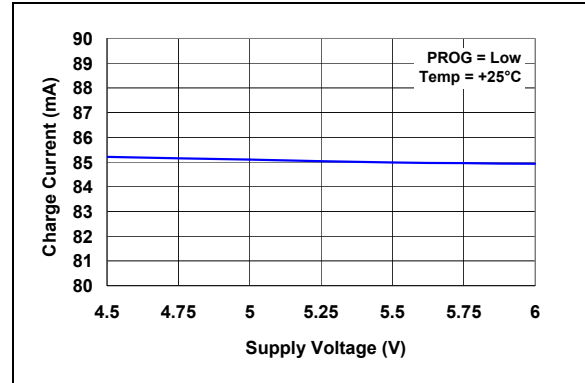

FIGURE 2-4: Charge Current (I_{OUT}) vs. Supply Voltage (V_{DD}) - MCP73811.

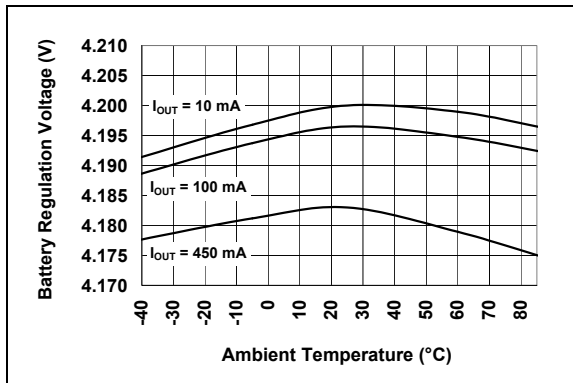

FIGURE 2-2: Battery Regulation Voltage (V_{BAT}) vs. Ambient Temperature (T_A).

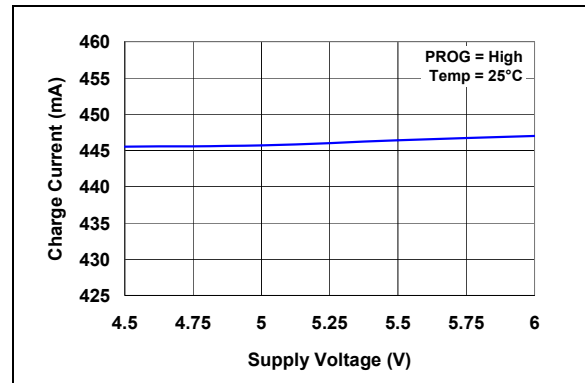

FIGURE 2-5: Charge Current (I_{OUT}) vs. Supply Voltage (V_{DD}) - MCP73811.

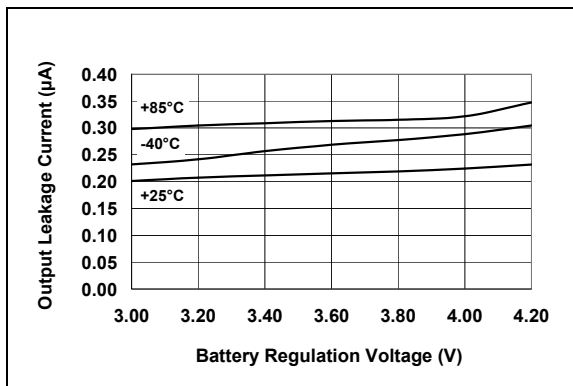

FIGURE 2-3: Output Leakage Current ($I_{DISCHARGE}$) vs. Battery Regulation Voltage (V_{BAT}).

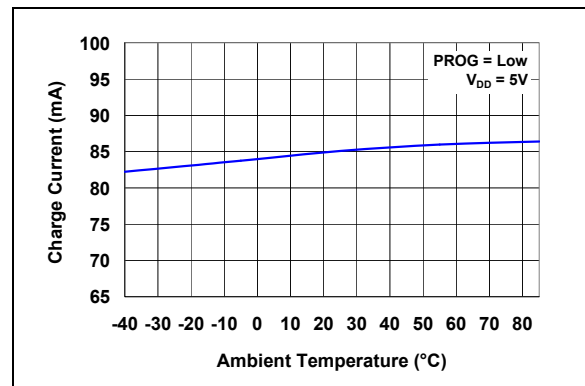

FIGURE 2-6: Charge Current (I_{OUT}) vs. Ambient Temperature (T_A) - MCP73811.

MCP73811/2

Typical Performance Curves (Continued)

Note: Unless otherwise indicated, $V_{DD} = [V_{REG}(typ.) + 1V]$, $I_{OUT} = 10\text{ mA}$ and $T_A = +25^\circ\text{C}$, Constant-voltage mode.

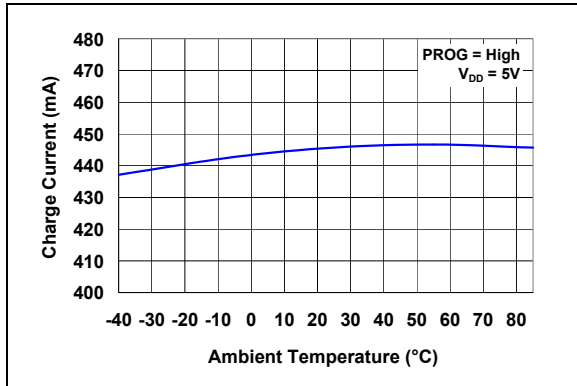

FIGURE 2-7: Charge Current (I_{OUT}) vs. Ambient Temperature (T_A) - MCP73811.

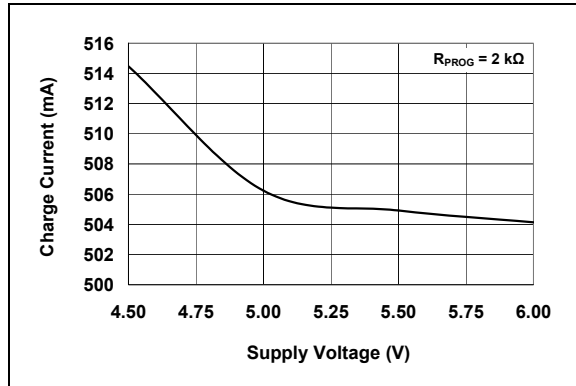

FIGURE 2-10: Charge Current (I_{OUT}) vs. Supply Voltage (V_{DD}) - MCP73812.

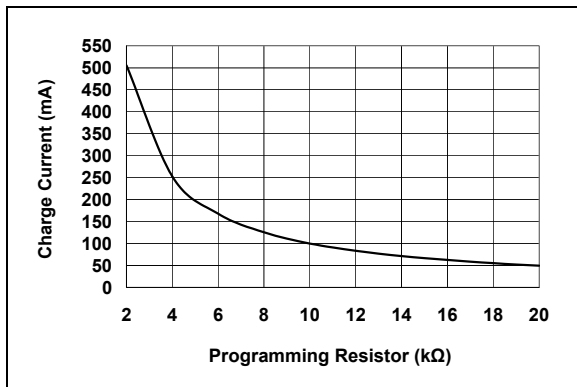

FIGURE 2-8: Charge Current (I_{OUT}) vs. Programming Resistor (R_{PROG}) - MCP73812.

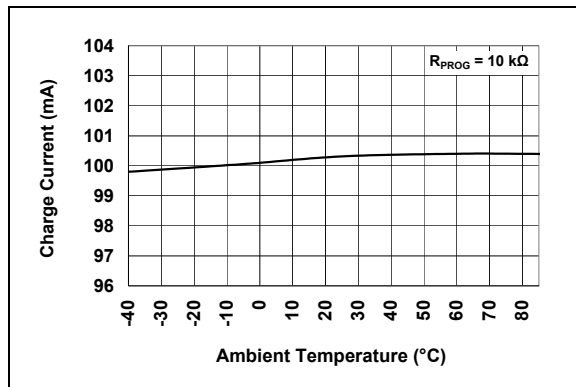

FIGURE 2-11: Charge Current (I_{OUT}) vs. Ambient Temperature (T_A) - MCP73812.

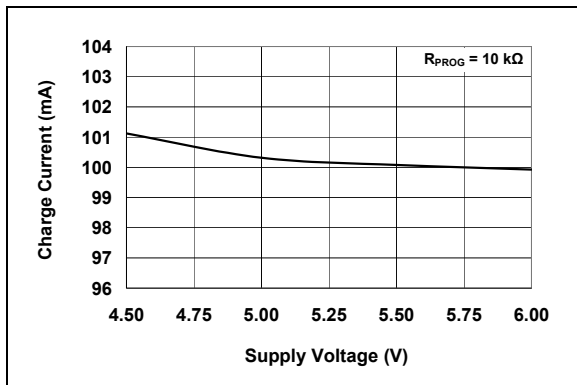

FIGURE 2-9: Charge Current (I_{OUT}) vs. Supply Voltage (V_{DD}) - MCP73812.

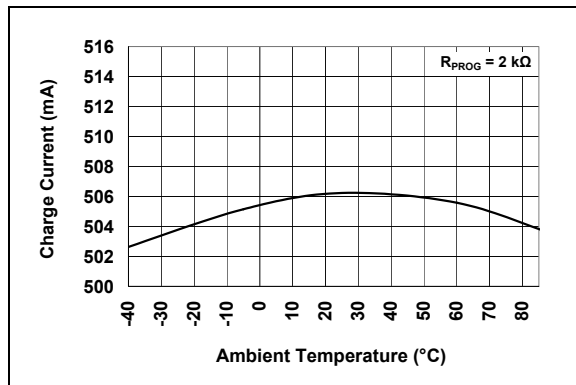

FIGURE 2-12: Charge Current (I_{OUT}) vs. Ambient Temperature (T_A) - MCP73812.

Typical Performance Curves (Continued)

Note: Unless otherwise indicated, $V_{DD} = [V_{REG}(typ.) + 1V]$, $I_{OUT} = 10\text{ mA}$ and $T_A = +25^\circ\text{C}$, Constant-voltage mode.

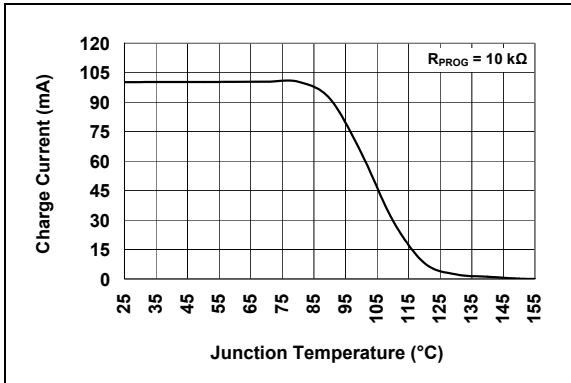

FIGURE 2-13: Charge Current (I_{OUT}) vs. Junction Temperature (T_J) - MCP73812.

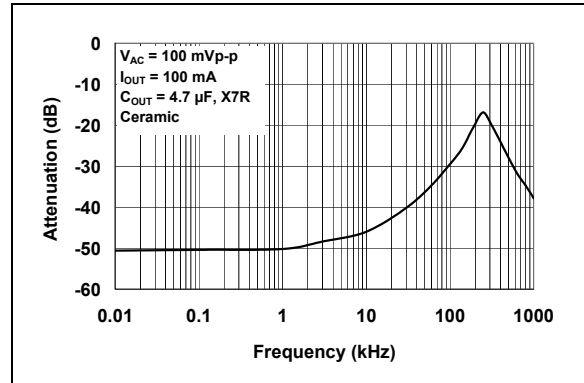

FIGURE 2-16: Power Supply Ripple Rejection (PSRR).

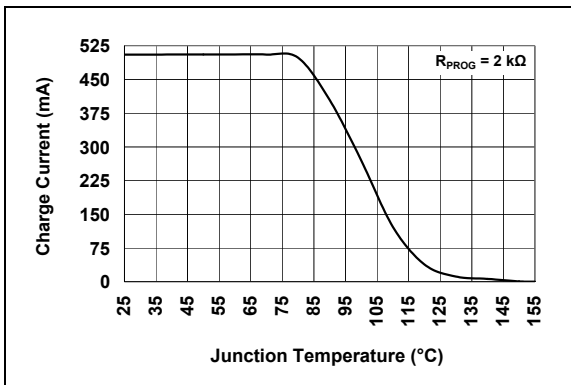

FIGURE 2-14: Charge Current (I_{OUT}) vs. Junction Temperature (T_J) - MCP73812.

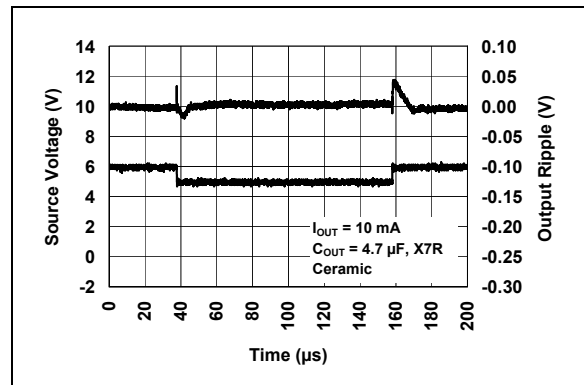

FIGURE 2-17: Line Transient Response.

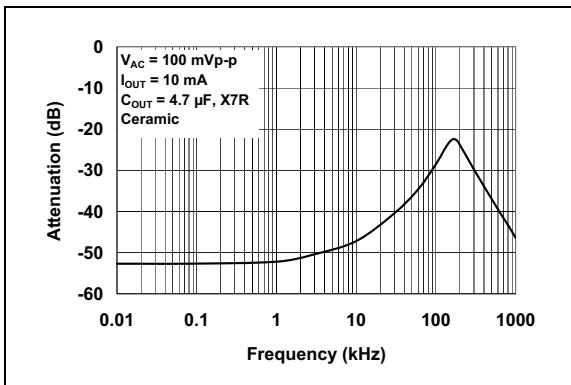

FIGURE 2-15: Power Supply Ripple Rejection (PSRR).

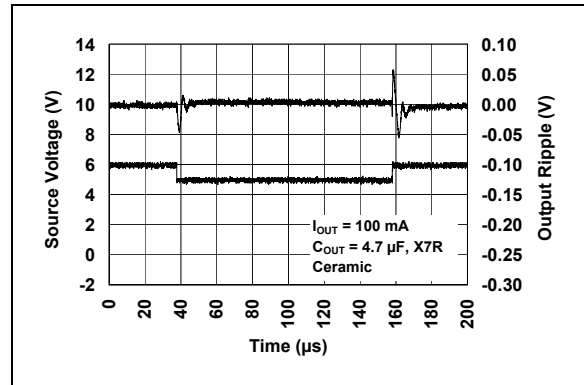

FIGURE 2-18: Line Transient Response.

MCP73811/2

Typical Performance Curves (Continued)

Note: Unless otherwise indicated, $V_{DD} = [V_{REG}(typ.) + 1V]$, $I_{OUT} = 10\text{ mA}$ and $T_A = +25^\circ\text{C}$, Constant-voltage mode.

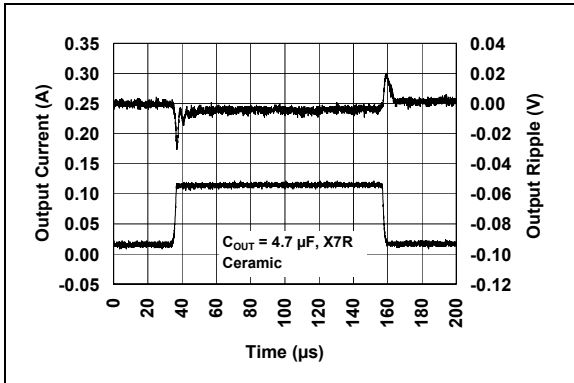

FIGURE 2-19: Load Transient Response.

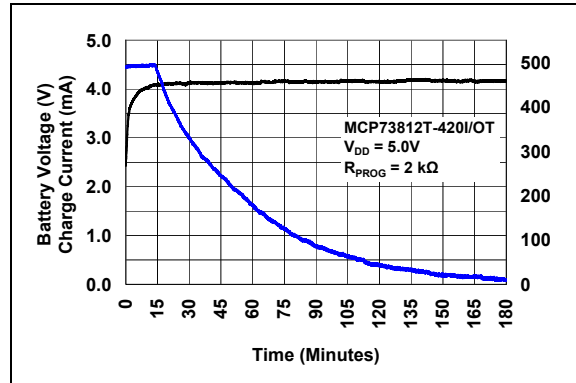

FIGURE 2-21: Typical Charge Profile (950 mAh) Li-Ion Battery.

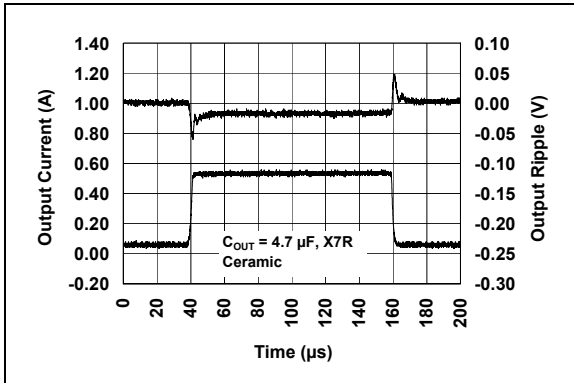

FIGURE 2-20: Load Transient Response.

3.0 PIN DESCRIPTION

The descriptions of the pins are listed in Table 3-1.

TABLE 3-1: PIN FUNCTION TABLES

Pin Number	Symbol	Function
SOT-23-5		
1	CE	Active High Charge Enable
2	V _{SS}	Battery Management 0V Reference
3	V _{BAT}	Battery Charge Control Output
4	V _{DD}	Battery Management Input Supply
5	PROG	Current Regulation Set and Charge Control Enable

3.1 Charge Enable Input (CE)

A logic High enables battery charging. A logic Low disables battery charging. The charge enable input is compatible with 1.8V logic.

3.2 Battery Management 0V Reference (V_{SS})

Connect to negative terminal of battery and input supply.

3.3 Battery Charge Control Output (V_{BAT})

Connect to positive terminal of battery. Drain terminal of internal P-channel MOSFET pass transistor. Bypass to V_{SS} with a minimum of 1 μF to ensure loop stability when the battery is disconnected.

3.4 Battery Management Input Supply (V_{DD})

A supply voltage of [V_{REG} (typ.) + 0.3V] to 6V is recommended. Bypass to V_{SS} with a minimum of 1 μF.

3.5 Current Regulation Set (PROG)

For the MCP73811, the current regulation set input (PROG) functions as a digital input selection. A logic Low selects a 85 mA charge current; a logic High selects a 450 mA charge current.

For the MCP73812, the charge current is set by placing a resistor from PROG to V_{SS}.

MCP73811/2

4.0 DEVICE OVERVIEW

The MCP73811/2 are simple, but fully integrated linear charge management controllers. Figure 4-1 depicts the operational flow algorithm.

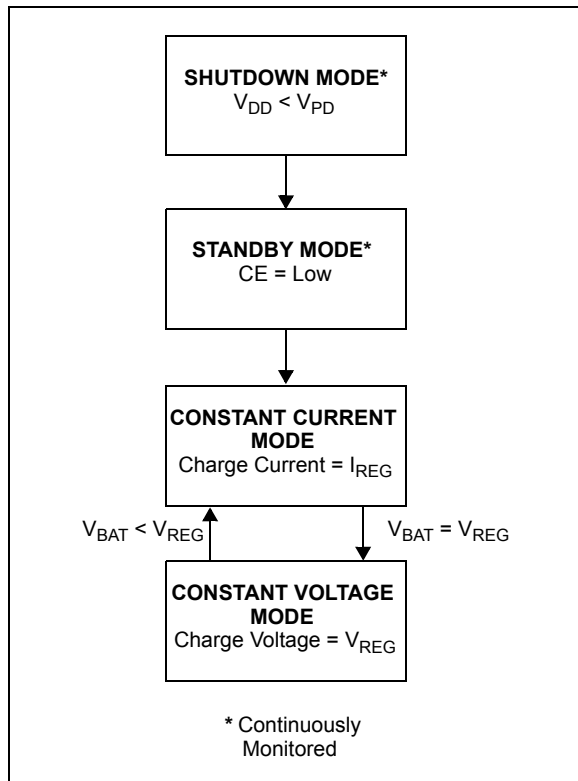

FIGURE 4-1: Flow Chart.

4.1 Undervoltage Lockout (UVLO)

The MCP73811/2 does not have an internal under voltage lockout (UVLO) circuit.

4.2 Charge Qualification

When the input power is applied, the input supply must rise 150 mV above the battery voltage before the MCP73811/2 becomes operational.

The automatic power down circuit places the device in a shutdown mode if the input supply falls to within +50 mV of the battery voltage.

The automatic circuit is always active. Whenever the input supply is within +50 mV of the voltage at the V_{BAT} pin, the MCP73811/2 is placed in a shutdown mode.

During power down condition, the battery reverse discharge current is less than 2 μA.

For a charge cycle to begin, the automatic power down conditions must be met and the charge enable input must be above the input high threshold.

4.3 PRECONDITIONING

The MCP73811/2 does not support preconditioning of deeply depleted cells.

4.4 Constant Current MODE - Fast Charge

During the constant current mode, the selected (MCP73811) or programmed (MCP73812) charge current is supplied to the battery or load.

For the MCP73812, the charge current is established using a single resistor from PROG to V_{SS}. The program resistor and the charge current are calculated using the following equation:

EQUATION 4-1:

$$I_{REG} = \frac{1000V}{R_{PROG}}$$

Where:

$$\begin{aligned} R_{PROG} &= \text{kilo-ohms} \\ I_{REG} &= \text{milliamperes} \end{aligned}$$

Constant current mode is maintained until the voltage at the V_{BAT} pin reaches the regulation voltage, V_{REG}.

4.5 Constant Voltage Mode

When the voltage at the V_{BAT} pin reaches the regulation voltage, V_{REG}, constant voltage regulation begins. The regulation voltage is factory set to 4.20V with a tolerance of ±1.0%.

4.6 Charge Termination

The charge cycle is terminated by removing the battery from the charger, removing input power, or driving the charge enable input (CE) to a logic Low. An automatic charge termination method is not implemented.

4.7 Automatic Recharge

The MCP73811/2 does not support automatic recharge cycles since automatic charge termination has not been implemented. In essence, the MCP73811/2 is always in a charge cycle whenever the qualification parameters have been met.

4.8 Thermal Regulation

The MCP73811/2 limits the charge current based on the die temperature. The thermal regulation optimizes the charge cycle time while maintaining device reliability. Figure 4-2 depicts the thermal regulation for the MCP73811/2.

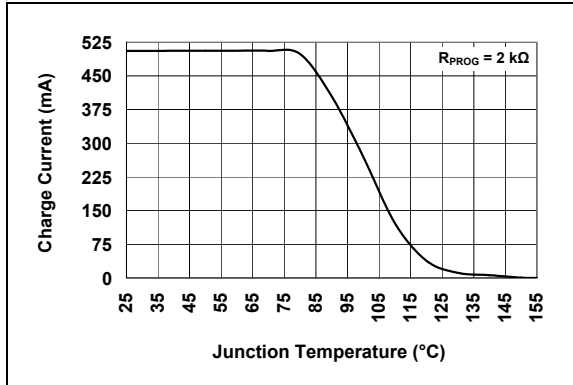

FIGURE 4-2: Thermal Regulation.

4.9 Thermal Shutdown

The MCP73811/2 suspends charge if the die temperature exceeds 150°C. Charging will resume when the die temperature has cooled by approximately 10°C. The thermal shutdown is a secondary safety feature in the event that there is a failure within the thermal regulation circuitry.

MCP73811/2

5.0 DETAILED DESCRIPTION

5.1 Analog Circuitry

5.1.1 BATTERY MANAGEMENT INPUT SUPPLY (V_{DD})

The V_{DD} input is the input supply to the MCP73811/2. The MCP73811/2 automatically enters a Power-down mode if the voltage on the V_{DD} input falls to within +50 mV of the battery voltage. This feature prevents draining the battery pack when the V_{DD} supply is not present.

5.1.2 MCP73812 CURRENT REGULATION SET (PROG)

For the MCP73812, the charge current regulation can be scaled by placing a programming resistor (R_{PROG}) from the PROG input to V_{SS} . The program resistor and the charge current are calculated using the following equation:

EQUATION 5-1:

$$I_{REG} = \frac{1000V}{R_{PROG}}$$

Where:

$$\begin{aligned} R_{PROG} &= \text{kilo-ohms} \\ I_{REG} &= \text{milliamperes} \end{aligned}$$

5.1.3 BATTERY CHARGE CONTROL OUTPUT (V_{BAT})

The battery charge control output is the drain terminal of an internal P-channel MOSFET. The MCP73811/2 provides constant current and voltage regulation to the battery pack by controlling this MOSFET in the linear region. The battery charge control output should be connected to the positive terminal of the battery pack.

5.2 Digital Circuitry

5.2.1 CHARGE ENABLE (CE)

The charge enable input pin (CE) can be used to terminate a charge at any time during the charge cycle, as well as to initiate a charge cycle or initiate a recharge cycle.

Driving the input to a logic High enables the device. Driving the input to a logic Low disables the device and terminates a charge cycle. When disabled, the device's supply current is reduced to 50 μ A, typically.

5.2.2 MCP73811 CURRENT REGULATION SELECT (PROG)

For the MCP73811, driving the PROG input to a logic Low selects the low charge current setting (85 mA). Driving the PROG input to a logic High selects the high charge current setting (450 mA).

6.0 APPLICATIONS

The MCP73811/2 is designed to operate in conjunction with a host microcontroller or in stand-alone applications. The MCP73811/2 provides the preferred

charge algorithm for Lithium-Ion and Lithium-Polymer cells Constant-current followed by Constant-voltage. [Figure 6-1](#) depicts a typical stand-alone application circuit, while [Figures 6-2](#) depict the accompanying charge profile.

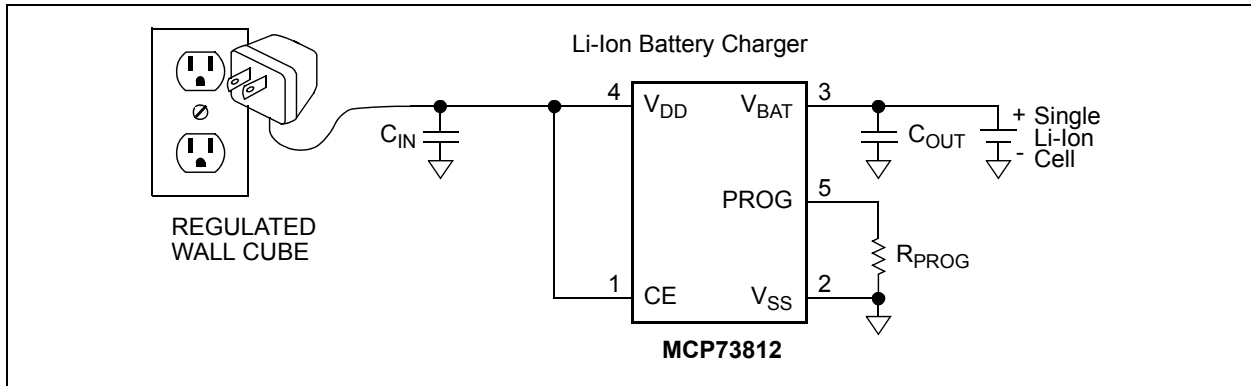

FIGURE 6-1: Typical Application Circuit.

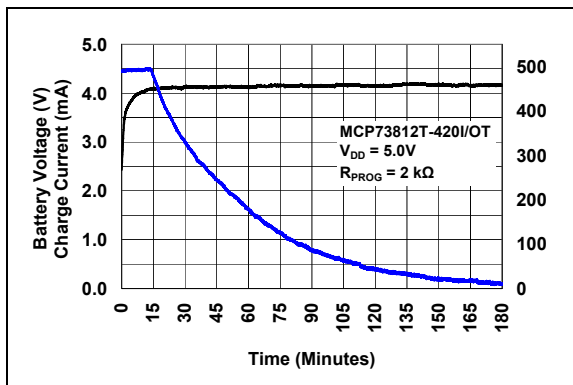

FIGURE 6-2: Typical Charge Profile (950 mAh Li-Ion Battery).

6.1 Application Circuit Design

Due to the low efficiency of linear charging, the most important factors are thermal design and cost, which are a direct function of the input voltage, output current and thermal impedance between the battery charger and the ambient cooling air. The worst-case situation is when the device has transitioned from the Preconditioning mode to the Constant-current mode. In this situation, the battery charger has to dissipate the maximum power. A trade-off must be made between the charge current, cost and thermal requirements of the charger.

6.1.1 COMPONENT SELECTION

Selection of the external components in [Figure 6-1](#) is crucial to the integrity and reliability of the charging system. The following discussion is intended as a guide for the component selection process.

6.1.1.1 Charge Current

The preferred fast charge current for Lithium-Ion cells is at the 1C rate, with an absolute maximum current at the 2C rate. For example, a 500 mAh battery pack has a preferred fast charge current of 500 mA. Charging at this rate provides the shortest charge cycle times without degradation to the battery pack performance or life.

MCP73811/2

6.1.1.2 Thermal Considerations

The worst-case power dissipation in the battery charger occurs when the input voltage is at the maximum and the device has transitioned from the Preconditioning mode to the Constant-current mode. In this case, the power dissipation is:

EQUATION 6-1:

$$PowerDissipation = (V_{DDMAX} - V_{PTHMIN}) \times I_{REGMAX}$$

Where:

- V_{DDMAX} = the maximum input voltage
- I_{REGMAX} = the maximum fast charge current
- V_{PTHMIN} = the minimum transition threshold voltage

Power dissipation with a 5V, ±10% input voltage source is:

EQUATION 6-2:

$$PowerDissipation = (5.5V - 2.7V) \times 500mA = 1.4W$$

This power dissipation with the battery charger in the SOT-23-5 package will cause thermal regulation to be entered as depicted in [Figure 6-3](#).

6.1.1.3 External Capacitors

The MCP73811/2 is stable with or without a battery load. In order to maintain good AC stability in the Constant-voltage mode, a minimum capacitance of 1 µF is recommended to bypass the V_{BAT} pin to V_{SS} . This capacitance provides compensation when there is no battery load. In addition, the battery and interconnections appear inductive at high frequencies. These elements are in the control feedback loop during Constant-voltage mode. Therefore, the bypass capacitance may be necessary to compensate for the inductive nature of the battery pack.

Virtually any good quality output filter capacitor can be used, independent of the capacitor's minimum Effective Series Resistance (ESR) value. The actual value of the capacitor (and its associated ESR) depends on the output load current. A 1 µF ceramic, tantalum or aluminum electrolytic capacitor at the output is usually sufficient to ensure stability for output currents up to a 500 mA.

6.1.1.4 Reverse-Blocking Protection

The MCP73811/2 provides protection from a faulted or shorted input. Without the protection, a faulted or shorted input would discharge the battery pack through the body diode of the internal pass transistor.

6.1.1.5 Charge Inhibit

The charge enable input pin (CE) can be used to terminate a charge at any time during the charge cycle, as well as to initiate a charge cycle or initiate a recharge cycle.

Driving the input to a logic High enables the device. Driving the input to a logic Low disables the device and terminates a charge cycle. When disabled, the device's supply current is reduced to 50 µA, typically.

6.2 PCB Layout Issues

For optimum voltage regulation, place the battery pack as close as possible to the device's V_{BAT} and V_{SS} pins, recommended to minimize voltage drops along the high current-carrying PCB traces.

If the PCB layout is used as a heatsink, adding many vias in the heatsink pad can help conduct more heat to the backplane of the PCB, thus reducing the maximum junction temperature. [Figures 6-3](#) and [6-4](#) depict a typical layout with PCB heatsinking.

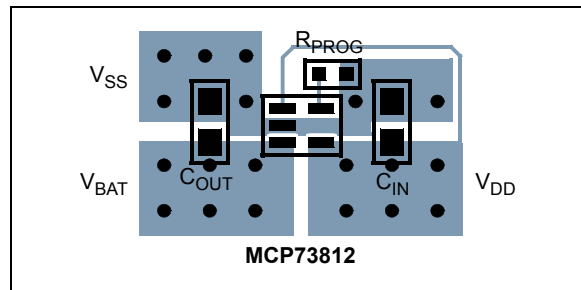

FIGURE 6-3: Typical Layout (Top).

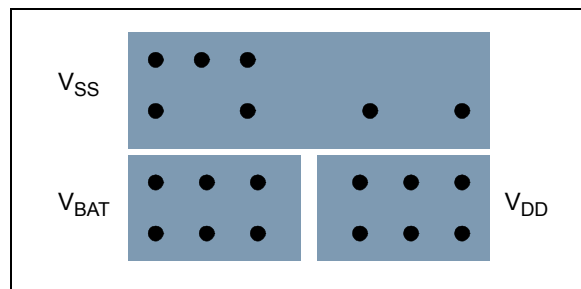
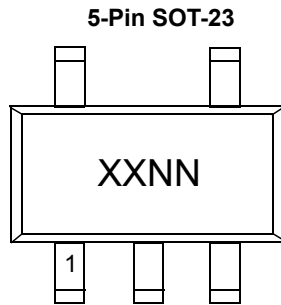

FIGURE 6-4: Typical Layout (Bottom).

7.0 PACKAGE INFORMATION

7.1 Package Marking Information



Standard *	
Part Number	Code
MCP73811T-420I/OT	KSNN
MCP73812T-420I/OT	KWNN

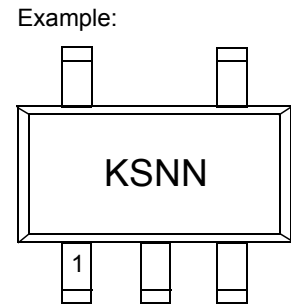

* Custom output voltages available upon request.

Contact your local Microchip sales office for more information.

Legend:	XX...X	Customer-specific information
	Y	Year code (last digit of calendar year)
	YY	Year code (last 2 digits of calendar year)
	WW	Week code (week of January 1 is week '01')
	NNN	Alphanumeric traceability code
	(e3)	Pb-free JEDEC designator for Matte Tin (Sn)
	*	This package is Pb-free. The Pb-free JEDEC designator (e3) can be found on the outer packaging for this package.

Note: In the event the full Microchip part number cannot be marked on one line, it will be carried over to the next line, thus limiting the number of available characters for customer-specific information.

MCP73811/2

5-Lead Plastic Small Outline Transistor (OT) [SOT-23]

Note: For the most current package drawings, please see the Microchip Packaging Specification located at <http://www.microchip.com/packaging>

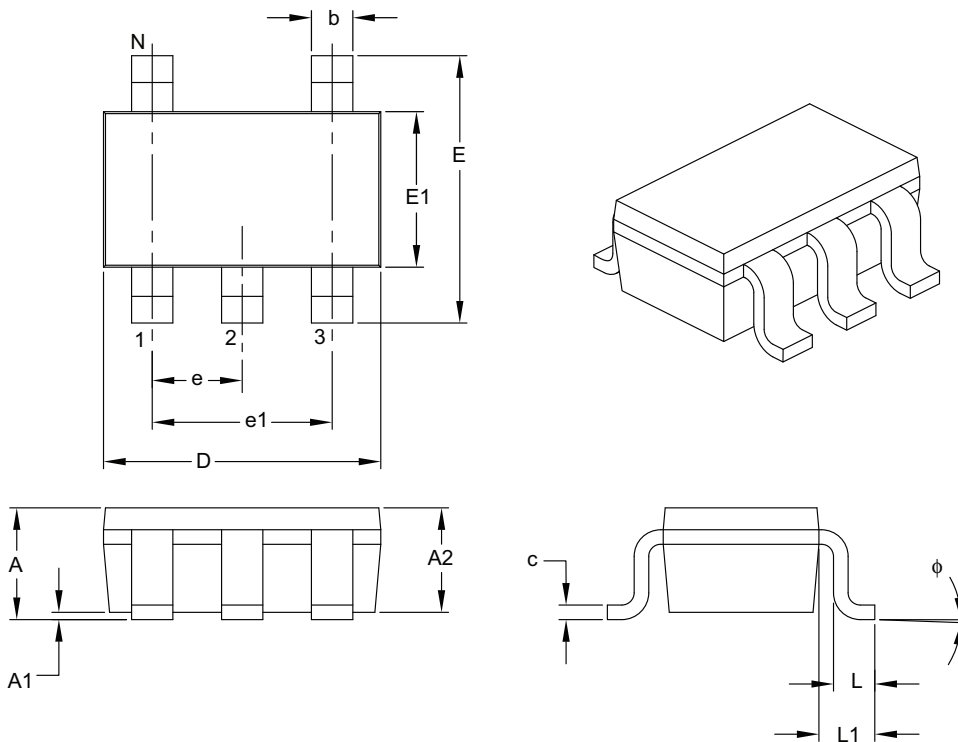

		Units	MILLIMETERS		
Dimension Limits			MIN	NOM	MAX
Number of Pins	N		5		
Lead Pitch	e		0.95 BSC		
Outside Lead Pitch	e1		1.90 BSC		
Overall Height	A		0.90	–	1.45
Molded Package Thickness	A2		0.89	–	1.30
Standoff	A1		0.00	–	0.15
Overall Width	E		2.20	–	3.20
Molded Package Width	E1		1.30	–	1.80
Overall Length	D		2.70	–	3.10
Foot Length	L		0.10	–	0.60
Footprint	L1		0.35	–	0.80
Foot Angle	ϕ		0°	–	30°
Lead Thickness	c		0.08	–	0.26
Lead Width	b		0.20	–	0.51

Notes:

- Dimensions D and E1 do not include mold flash or protrusions. Mold flash or protrusions shall not exceed 0.127 mm per side.
- Dimensioning and tolerancing per ASME Y14.5M.

BSC: Basic Dimension. Theoretically exact value shown without tolerances.

Microchip Technology Drawing C04-091B

APPENDIX A: REVISION HISTORY

Revision B (September 2007)

The following is the list of modifications:

1. Modified "No End-of-Charge Control" bullet to read "External End-of-Charge Control".
2. Deleted No Undervoltage Lockout (UVLO) bullet
3. Replaced Figure 2-21 with new plot and changed figure caption.
4. Deleted Figure 2-22.
5. Replaced Figure 6-2 with new plot and changed figure caption.
6. Deleted Figure 6-3.
7. Updated revision history.

Revision A (March 2007)

- Original Release of this Document.

MCP73811/2

NOTES:

PRODUCT IDENTIFICATION SYSTEM

To order or obtain information, e.g., on pricing or delivery, refer to the factory or the listed sales office.

<u>PART NO.</u>	—	<u>XXX</u>	<u>X</u>	<u>/XX</u>
Device		Voltage Options	Temperature	Package
Device:		MCP73811T: Li-Ion Charger w/Selectable Charge Current, Tape and Reel MCP73812T: Li-Ion Charger w/Selectable Charge Current, Tape and Reel		
Voltage Options *:		420 = 4.2V "Standard" *Contact factory for other output voltage options.		
Temperature:		I = -40°C to +85°C		
Package Type:		OT = Small Outline Transistor (SOT-23), 5-lead		

Examples:

- a) MCP73811T-420I/OT: 4.2V Charger SOT-23-5 pkg.
- a) MCP73812T-420I/OT: 4.2V Charger SOT-23-5 pkg.

MCP73811/2

NOTES:

Note the following details of the code protection feature on Microchip devices:

- Microchip products meet the specification contained in their particular Microchip Data Sheet.
- Microchip believes that its family of products is one of the most secure families of its kind on the market today, when used in the intended manner and under normal conditions.
- There are dishonest and possibly illegal methods used to breach the code protection feature. All of these methods, to our knowledge, require using the Microchip products in a manner outside the operating specifications contained in Microchip's Data Sheets. Most likely, the person doing so is engaged in theft of intellectual property.
- Microchip is willing to work with the customer who is concerned about the integrity of their code.
- Neither Microchip nor any other semiconductor manufacturer can guarantee the security of their code. Code protection does not mean that we are guaranteeing the product as “unbreakable.”

Code protection is constantly evolving. We at Microchip are committed to continuously improving the code protection features of our products. Attempts to break Microchip's code protection feature may be a violation of the Digital Millennium Copyright Act. If such acts allow unauthorized access to your software or other copyrighted work, you may have a right to sue for relief under that Act.

Information contained in this publication regarding device applications and the like is provided only for your convenience and may be superseded by updates. It is your responsibility to ensure that your application meets with your specifications. MICROCHIP MAKES NO REPRESENTATIONS OR WARRANTIES OF ANY KIND WHETHER EXPRESS OR IMPLIED, WRITTEN OR ORAL, STATUTORY OR OTHERWISE, RELATED TO THE INFORMATION, INCLUDING BUT NOT LIMITED TO ITS CONDITION, QUALITY, PERFORMANCE, MERCHANTABILITY OR FITNESS FOR PURPOSE. Microchip disclaims all liability arising from this information and its use. Use of Microchip devices in life support and/or safety applications is entirely at the buyer's risk, and the buyer agrees to defend, indemnify and hold harmless Microchip from any and all damages, claims, suits, or expenses resulting from such use. No licenses are conveyed, implicitly or otherwise, under any Microchip intellectual property rights.

Trademarks

The Microchip name and logo, the Microchip logo, Accuron, dsPIC, KEELOQ, KEELOQ logo, microID, MPLAB, PIC, PICmicro, PICSTART, PRO MATE, rPIC and SmartShunt are registered trademarks of Microchip Technology Incorporated in the U.S.A. and other countries.

AmpLab, FilterLab, Linear Active Thermistor, Migratable Memory, MXDEV, MXLAB, SEEVAL, SmartSensor and The Embedded Control Solutions Company are registered trademarks of Microchip Technology Incorporated in the U.S.A.

Analog-for-the-Digital Age, Application Maestro, CodeGuard, dsPICDEM, dsPICDEM.net, dsPICworks, dsSPEAK, ECAN, ECONOMONITOR, FanSense, FlexROM, fuzzyLAB, In-Circuit Serial Programming, ICSP, ICEPIC, Mindi, MiWi, MPASM, MPLAB Certified logo, MPLIB, MPLINK, PICkit, PICDEM, PICDEM.net, PICLAB, PICtail, PowerCal, PowerInfo, PowerMate, PowerTool, REAL ICE, rLAB, Select Mode, Smart Serial, SmartTel, Total Endurance, UNI/O, WiperLock and ZENA are trademarks of Microchip Technology Incorporated in the U.S.A. and other countries.

SQTP is a service mark of Microchip Technology Incorporated in the U.S.A.

All other trademarks mentioned herein are property of their respective companies.

© 2007, Microchip Technology Incorporated, Printed in the U.S.A., All Rights Reserved.

 Printed on recycled paper.

QUALITY MANAGEMENT SYSTEM
CERTIFIED BY DNV
== ISO/TS 16949:2002 ==

Microchip received ISO/TS-16949:2002 certification for its worldwide headquarters, design and wafer fabrication facilities in Chandler and Tempe, Arizona; Gresham, Oregon and design centers in California and India. The Company's quality system processes and procedures are for its PIC® MCUs and dsPIC® DSCs, KEELOQ® code hopping devices, Serial EEPROMs, microperipherals, nonvolatile memory and analog products. In addition, Microchip's quality system for the design and manufacture of development systems is ISO 9001:2000 certified.



WORLDWIDE SALES AND SERVICE

AMERICAS

Corporate Office

2355 West Chandler Blvd.
Chandler, AZ 85224-6199
Tel: 480-792-7200
Fax: 480-792-7277
Technical Support:
<http://support.microchip.com>
Web Address:
www.microchip.com

Atlanta

Duluth, GA
Tel: 678-957-9614
Fax: 678-957-1455

Boston

Westborough, MA
Tel: 774-760-0087
Fax: 774-760-0088

Chicago

Itasca, IL
Tel: 630-285-0071
Fax: 630-285-0075

Dallas

Addison, TX
Tel: 972-818-7423
Fax: 972-818-2924

Detroit

Farmington Hills, MI
Tel: 248-538-2250
Fax: 248-538-2260

Kokomo

Kokomo, IN
Tel: 765-864-8360
Fax: 765-864-8387

Los Angeles

Mission Viejo, CA
Tel: 949-462-9523
Fax: 949-462-9608

Santa Clara

Santa Clara, CA
Tel: 408-961-6444
Fax: 408-961-6445

Toronto

Mississauga, Ontario,
Canada
Tel: 905-673-0699
Fax: 905-673-6509

ASIA/PACIFIC

Asia Pacific Office

Suites 3707-14, 37th Floor
Tower 6, The Gateway
Harbour City, Kowloon
Hong Kong
Tel: 852-2401-1200
Fax: 852-2401-3431

Australia - Sydney

Tel: 61-2-9868-6733
Fax: 61-2-9868-6755

China - Beijing

Tel: 86-10-8528-2100
Fax: 86-10-8528-2104

China - Chengdu

Tel: 86-28-8665-5511
Fax: 86-28-8665-7889

China - Fuzhou

Tel: 86-591-8750-3506
Fax: 86-591-8750-3521

China - Hong Kong SAR

Tel: 852-2401-1200
Fax: 852-2401-3431

China - Qingdao

Tel: 86-532-8502-7355
Fax: 86-532-8502-7205

China - Shanghai

Tel: 86-21-5407-5533
Fax: 86-21-5407-5066

China - Shenyang

Tel: 86-24-2334-2829
Fax: 86-24-2334-2393

China - Shenzhen

Tel: 86-755-8203-2660
Fax: 86-755-8203-1760

China - Shunde

Tel: 86-757-2839-5507
Fax: 86-757-2839-5571

China - Wuhan

Tel: 86-27-5980-5300
Fax: 86-27-5980-5118

China - Xian

Tel: 86-29-8833-7252
Fax: 86-29-8833-7256

ASIA/PACIFIC

India - Bangalore

Tel: 91-80-4182-8400
Fax: 91-80-4182-8422

India - New Delhi

Tel: 91-11-4160-8631
Fax: 91-11-4160-8632

India - Pune

Tel: 91-20-2566-1512
Fax: 91-20-2566-1513

Japan - Yokohama

Tel: 81-45-471- 6166
Fax: 81-45-471-6122

Korea - Daegu

Tel: 82-53-744-4301
Fax: 82-53-744-4302

Korea - Seoul

Tel: 82-2-554-7200
Fax: 82-2-558-5932 or
82-2-558-5934

Malaysia - Penang

Tel: 60-4-646-8870
Fax: 60-4-646-5086

Philippines - Manila

Tel: 63-2-634-9065
Fax: 63-2-634-9069

Singapore

Tel: 65-6334-8870
Fax: 65-6334-8850

Taiwan - Hsin Chu

Tel: 886-3-572-9526
Fax: 886-3-572-6459

Taiwan - Kaohsiung

Tel: 886-7-536-4818
Fax: 886-7-536-4803

Taiwan - Taipei

Tel: 886-2-2500-6610
Fax: 886-2-2508-0102

Thailand - Bangkok

Tel: 66-2-694-1351
Fax: 66-2-694-1350

EUROPE

Austria - Wels

Tel: 43-7242-2244-39
Fax: 43-7242-2244-393

Denmark - Copenhagen

Tel: 45-4450-2828
Fax: 45-4485-2829

France - Paris

Tel: 33-1-69-53-63-20
Fax: 33-1-69-30-90-79

Germany - Munich

Tel: 49-89-627-144-0
Fax: 49-89-627-144-44

Italy - Milan

Tel: 39-0331-742611
Fax: 39-0331-466781

Netherlands - Drunen

Tel: 31-416-690399
Fax: 31-416-690340

Spain - Madrid

Tel: 34-91-708-08-90
Fax: 34-91-708-08-91

UK - Wokingham

Tel: 44-118-921-5869
Fax: 44-118-921-5820

06/25/07