

WWW.TOOWHEELS.ORG

PLANS SIZE-ME: ERGONOMICAL DIMENSION

TOOWHEELS IS A DIY WHEELCHAIR, YOU CAN BUILD USING SIMPLE MATERIALS AND TOOLS: SOME PLYWOOD, SOME PIPES, SOME BICYCLE PARTS AND YOUR WHEELCHAIR IS READY!
YOU CAN CHANGE DIMENSION AND SIZE, AND IF YOU WANT YOU CAN MAKE A CUSTOM WHEELCHAIR FOR ANY NEEDS YOU HAVE!

TOOWHEELS IS A PATENT PENDING PROJECT,
RELEASED IN OPEN SOURCE VERSION (CC licence NON COMMERCIAL, SHARE ALIKE) TO BE USEFULL FOR PEOPLE ALL OVER THE WORLD. MAKE IT FOR YOUR FRIENDS, FOR PEOPLE OF YOUR CITY, MAKE IT IN A FABLAB OR A MAKERSPACE OR AT HOME!!

MAKE IT AND ENJOY!

FOLLOW US ON FB: **TooWheels**
SITE: **WWW.TOOWHEELS.ORG**
E-MAIL: **ALESSIOFABRIZIOGIORGIO@GMAIL.COM**

CREATE THE PLANS!

ASSEMBLING THE SHEETS USING SCOTCH TAPE, AS SHOWN IN THE SCHEME BELOW

PLANS 1

			9
5	6	7	8

PLANS 2

20	21	22	23
24	25	26	

PLANS 3

12	13
----	----

PLANS 4

14	15	16	17
----	----	----	----

PLANS 5

18	19
----	----

PLANS 6

27	28	29	30
----	----	----	----

PLANS 7

31	32
----	----



SIZE-ME!

MEASURE YOUR BODY PARTS AND COMPLETE THIS SHEET WHERE INDICATED BY THE DOTS

SEAT'S WIDTH

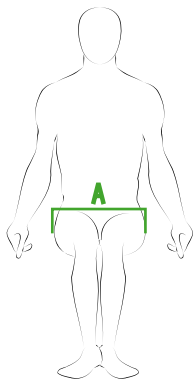

MEASURE THE WIDTH OF YOUR BASIN FROM AN HIP TO THE OTHER

A:

SEAT'S DEPTH

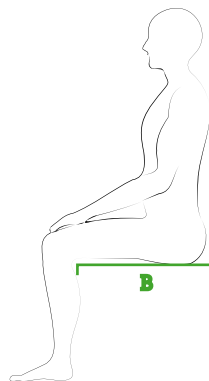

SIT DOWN AND MEASURE THE LENGTH OF YOUR FEMUR, FROM BEHIND THE KNEE TO YOUR BACK

B:

BACKREST'S HEIGHT

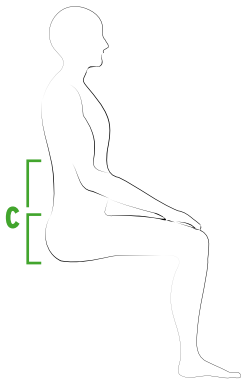

CHOOSE THE LENGTH OF THE BACK MORE CONVENIENT FOR YOU, OR MEASURE THAT OF YOUR WHEELCHAIR. TO SEAT EASILY AND FOR MORE STABILITY CHOOSE AN HIGHER BEACK.

C:

BACKREST'S ANGLE

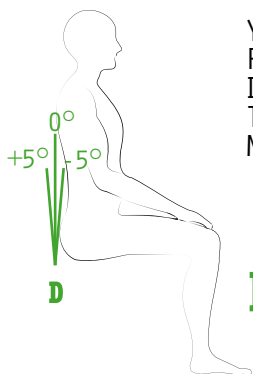

YOU HAVE TO EVALUATE THE REQUIRED SEAT ANGLE ACCORDING TO THE DESIRED STABILITY, OR MEASURE THAT OF YOUR WHEELCHAIR. FOR MORE STABILITY CHOOSE $+5^\circ$ ANGLE

D:

SEAT'S ANGLE

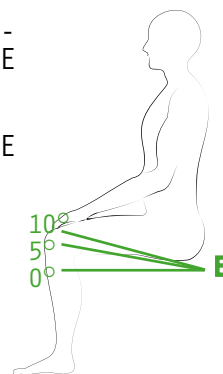

YOU HAVE TO EVALUATE THE REQUIRED SEAT ANGLE ACCORDING TO THE DESIRED STABILITY, OR MEASURE THAT OF YOUR WHEELCHAIR. FOR SUFFICIENT STABILITY CHOOSE 5° ANGLE

E:

SEAT'S HEIGHT

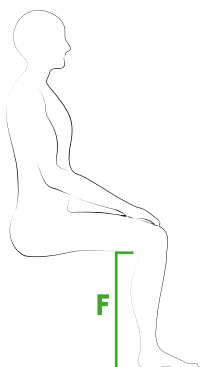

MEASURE YOUR SHIN FROM BELOW THE KNEE TO THE PLANT OF YOUR FEET

F:

SEAT-TIME!

WITH THIS SCHEME CAN BRING YOUR MEASURES AND GIVE THE PROPERLY DIMENSION TO YOUR SEAT. FOLLOW THE INSTRUCTION, YOU COULD NEED TO HAVE SOME MATH OPERATION AT THE BODY'S MEASURES YOU HAVE JUST TAKEN!

1-SEAT'S DEPTH

MEASURE "B" - 10 CM =....

2-SEAT'S ANGLE

DECIDE THE ANGLE OF THE SEAT USING MEASURE "E". UNDERLINE THE RECTANGLE WITH THE CORRECT ANGLE YOU WANT.

3-BACKREST'S HEIGHT

MEASURE "C"

4-BACKREST'S ANGLE

DECIDE THE ANGLE OF THE BACKREST USING MEASURE "D". UNDERLINE THE RECTANGLE WITH THE CORRECT ANGLE YOU WANT.

AFTER MARKED DIMENSIONS ON THE SHEETS PLANS AND CUSTOM YOUR PROJECT, CUT YOUR SEAT OUTLINE

MEASURE E: SEAT'S ANGLE

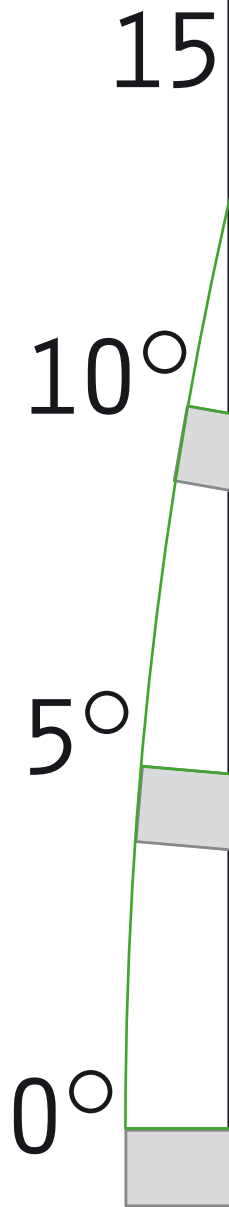

PLAN 1

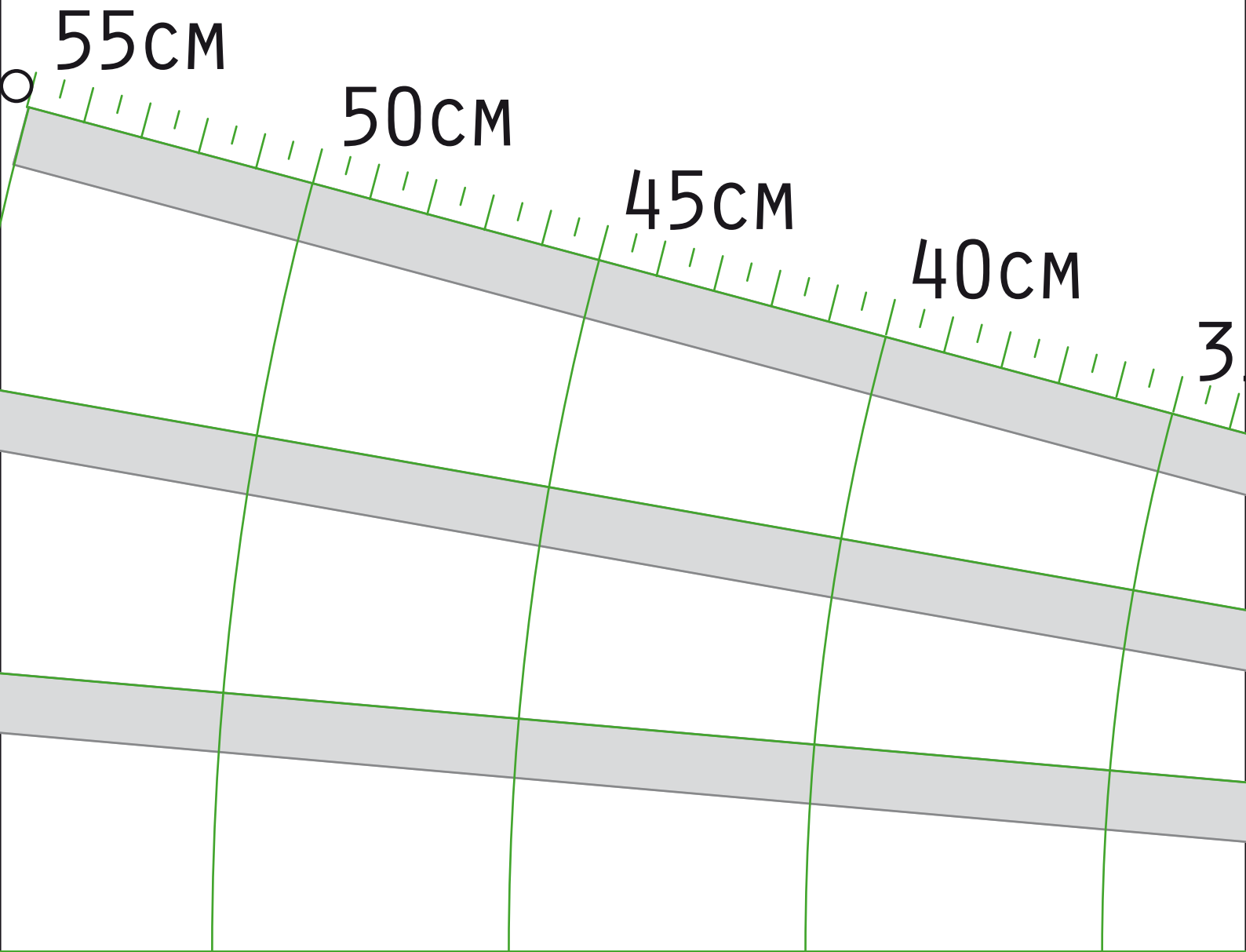

PLAN 1

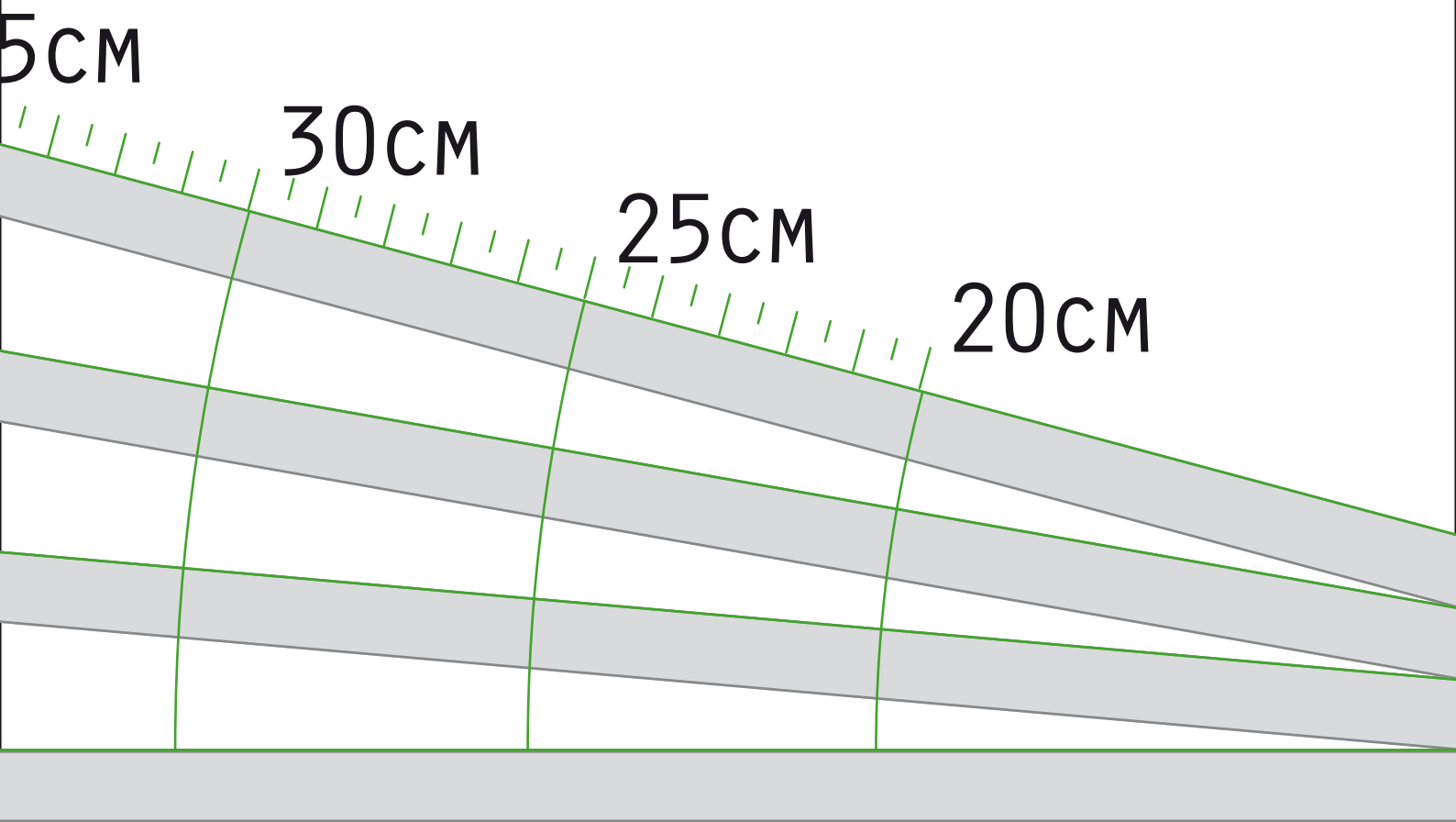

MEASURE **B-10CM** : SEAT'S LENGHT

PLAN 1

20CM

15CM

10CM

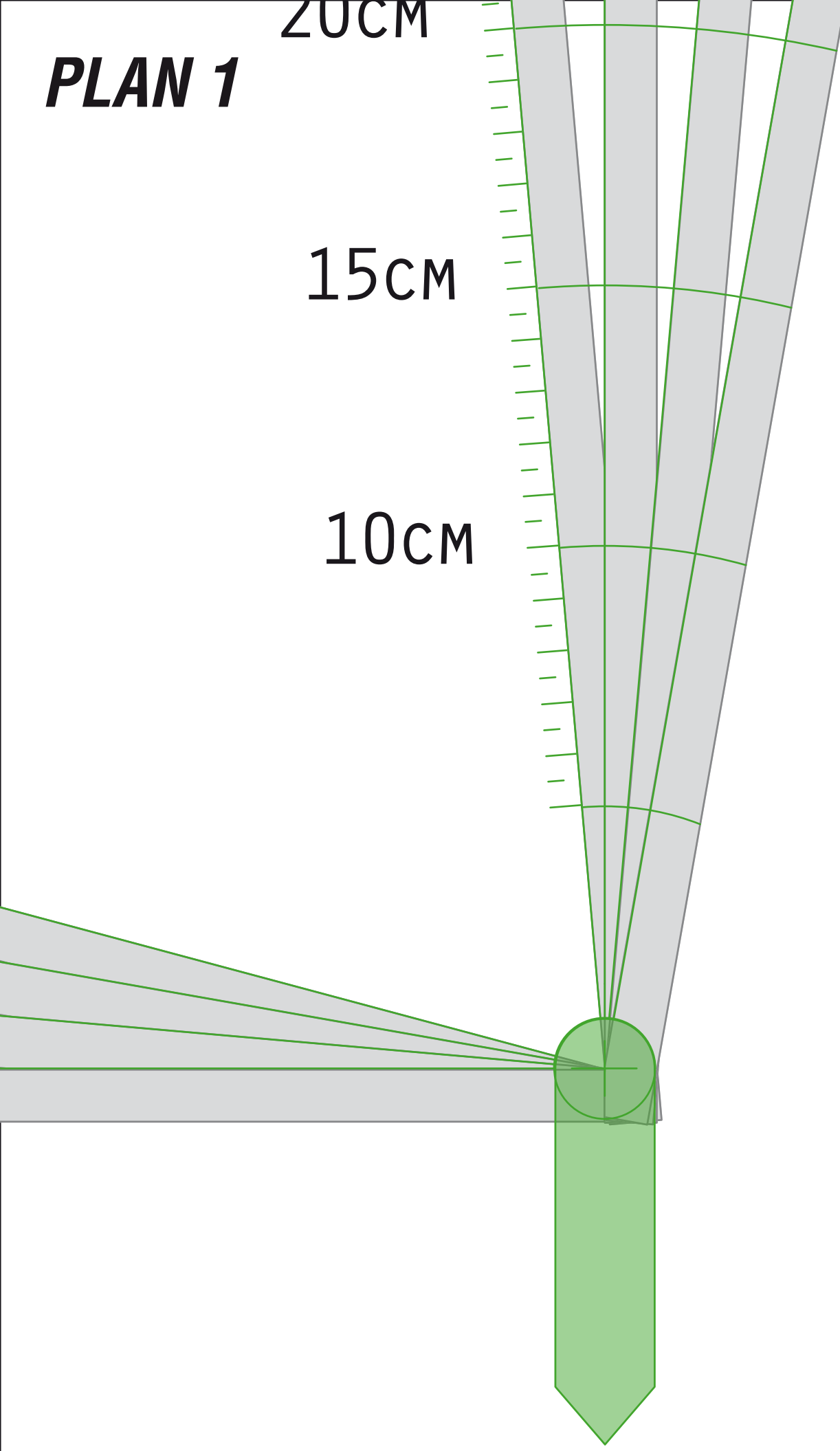

MEASURE **C**: BACKREST'S LENGHT

PLAN 1

MEASURE **D**: BACKREST'S ANGLE

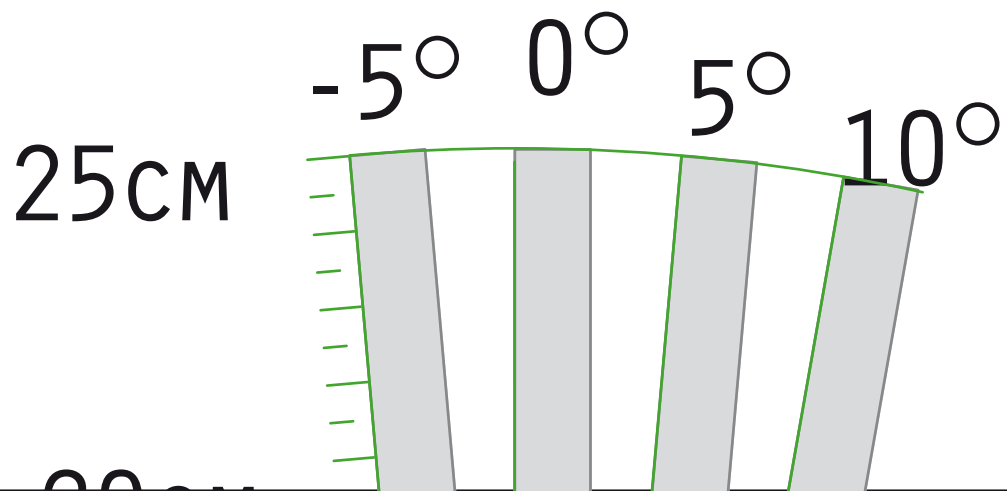

PLAN 3

BACKREST SUPPORT, CUT AT THE SAME HEIGHT OF THE BACKREST

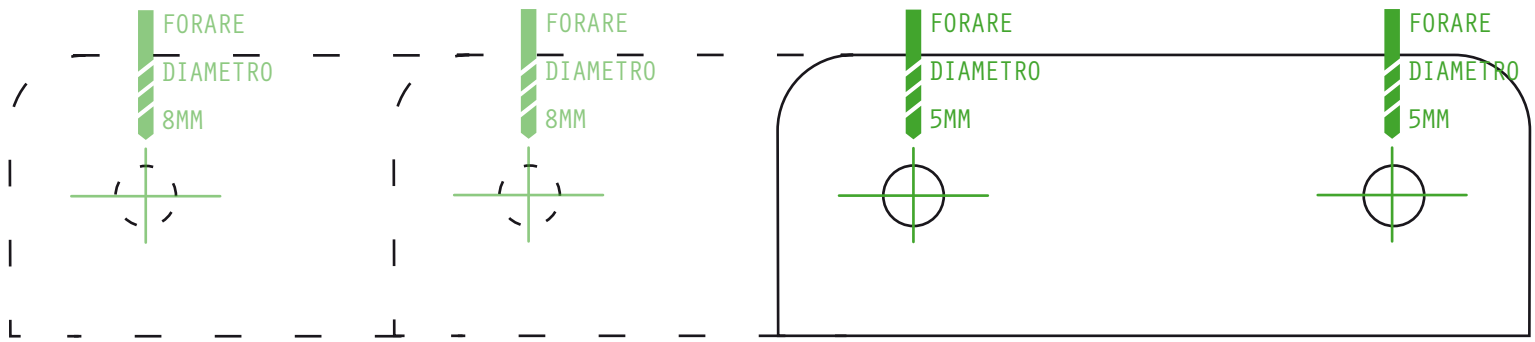

SEAT SUPPORT, CUT AT THE SAME LENGTH OF THE SEAT



BUMPER SUPPORT

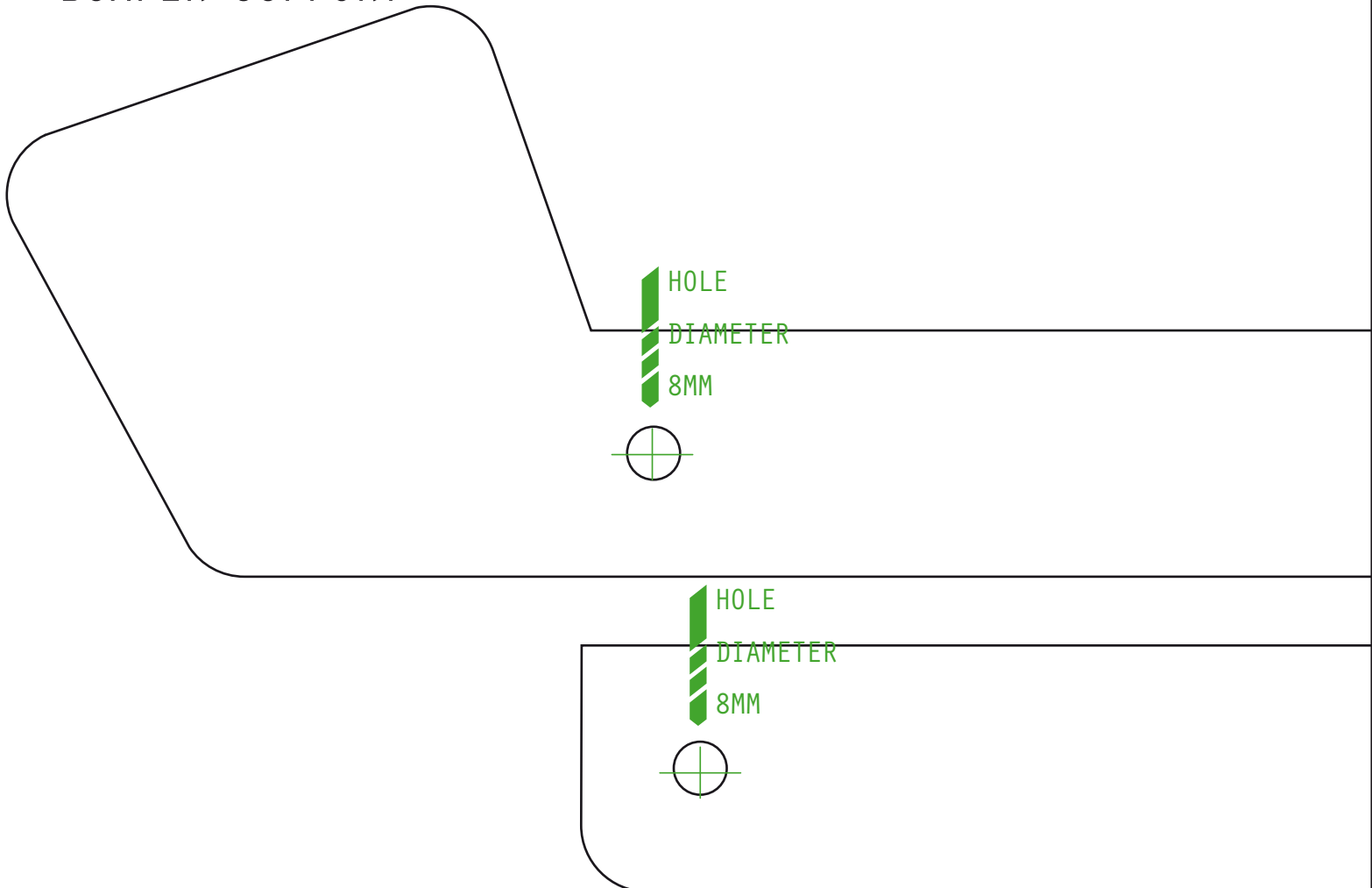

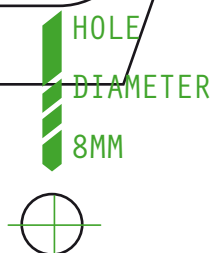
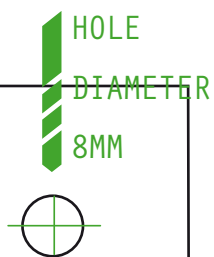
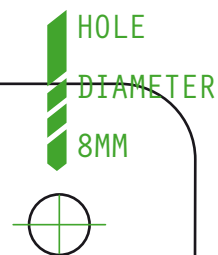
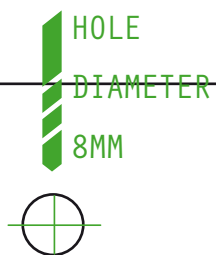

PLAN 4

EXTERNAL SIDES

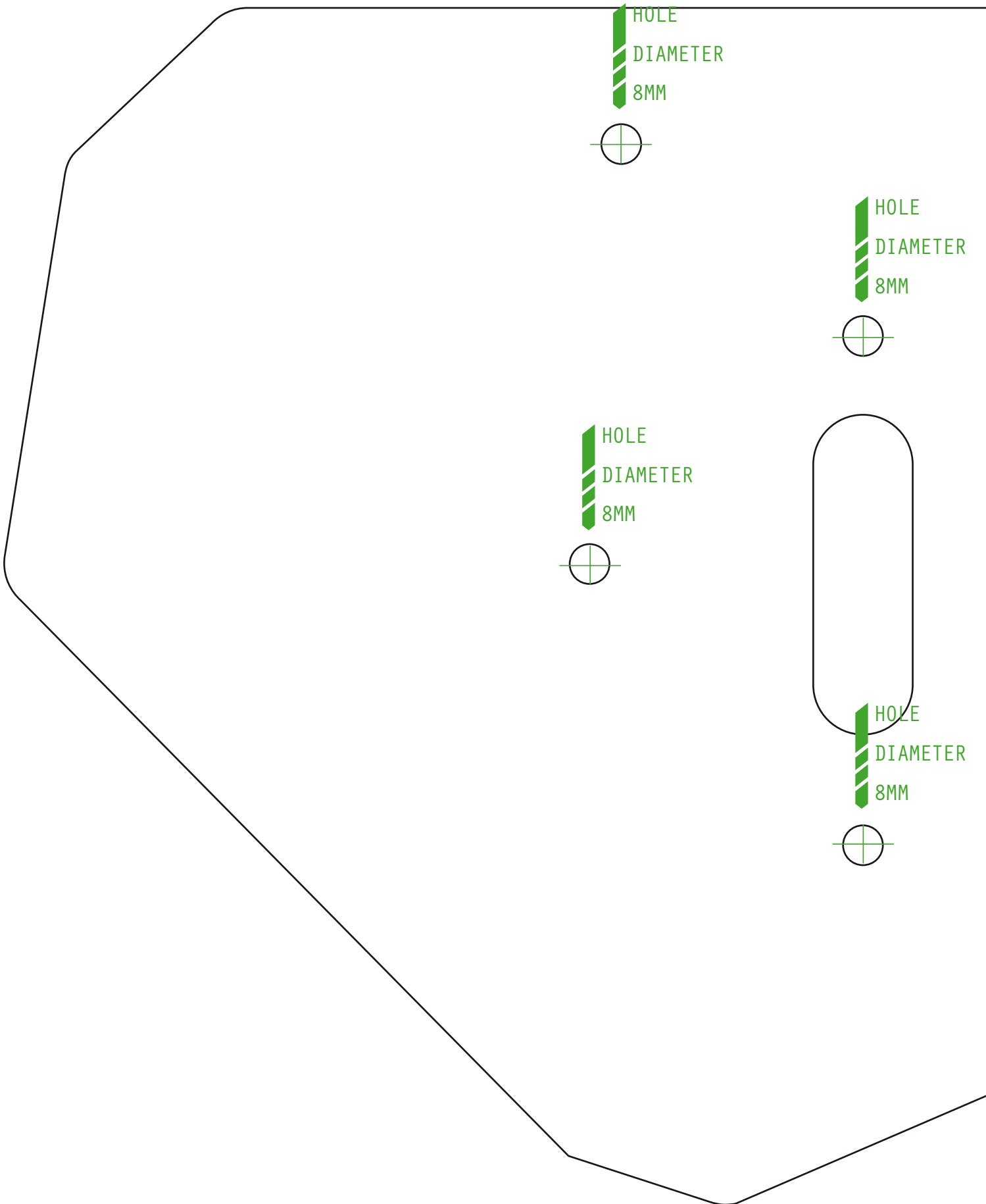

BUMPER SUPPORT

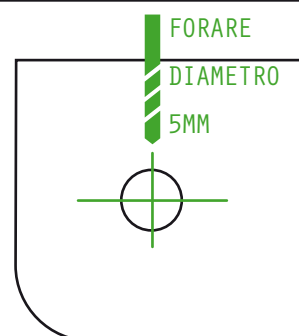
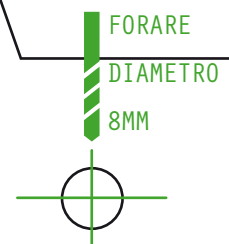
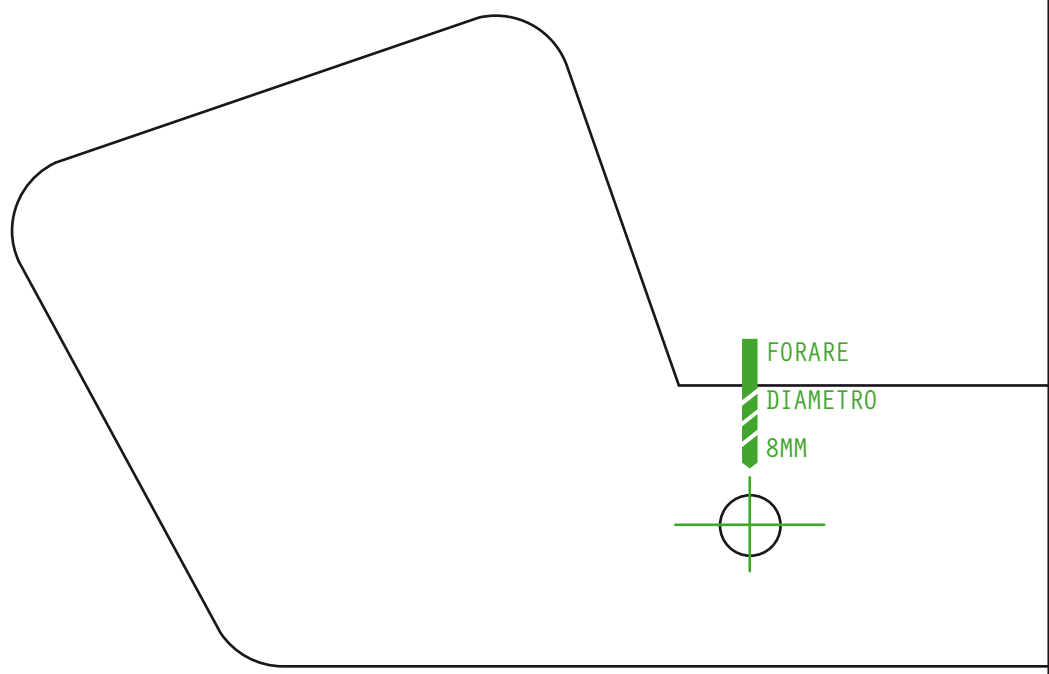
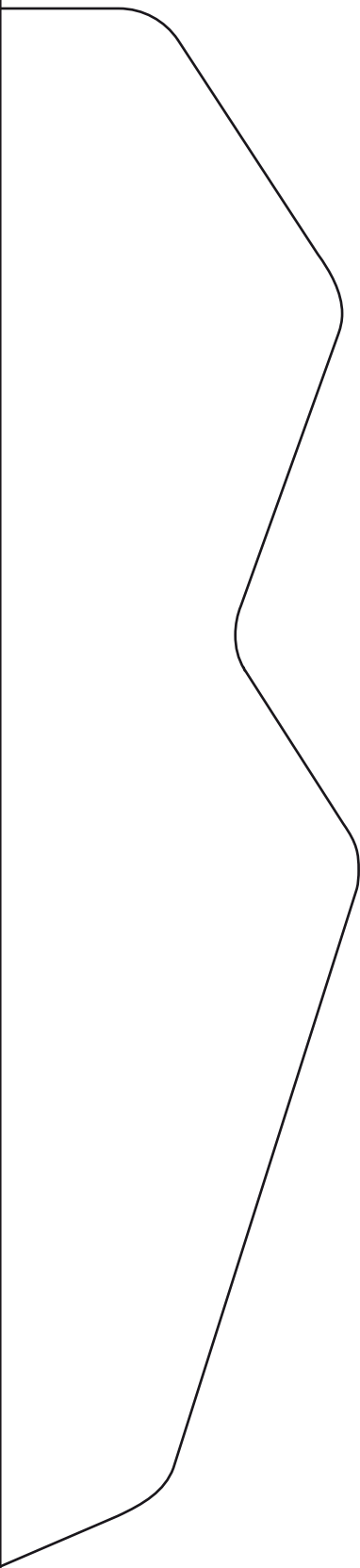

EXTERNAL SIDES

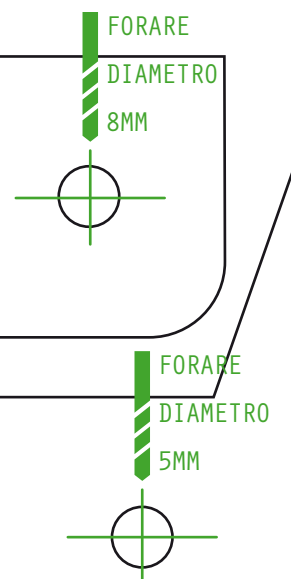
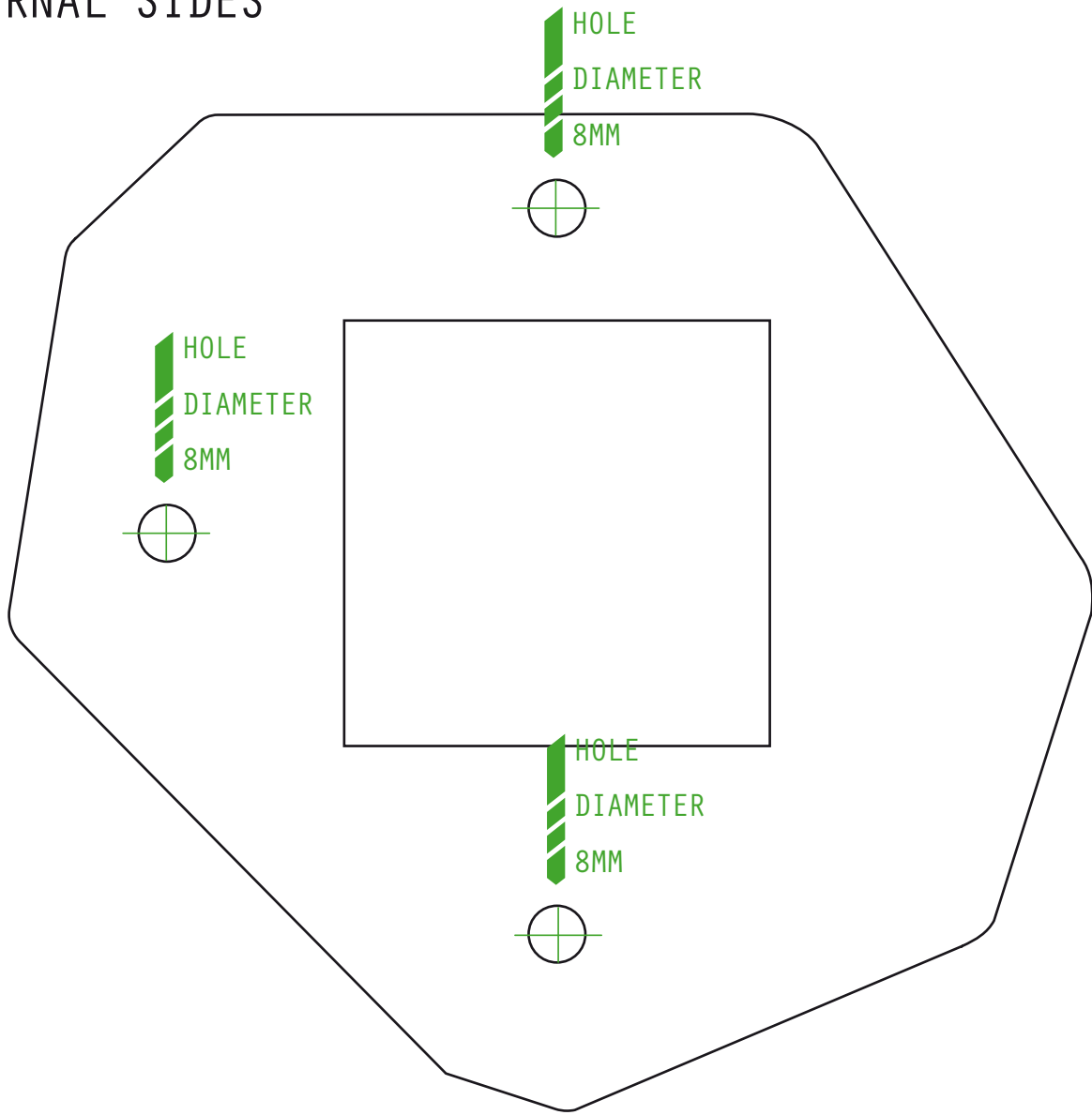

EXTERNAL SIDES

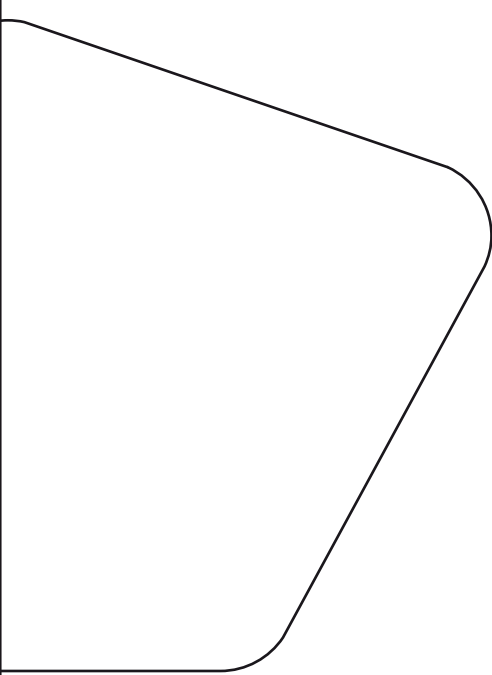
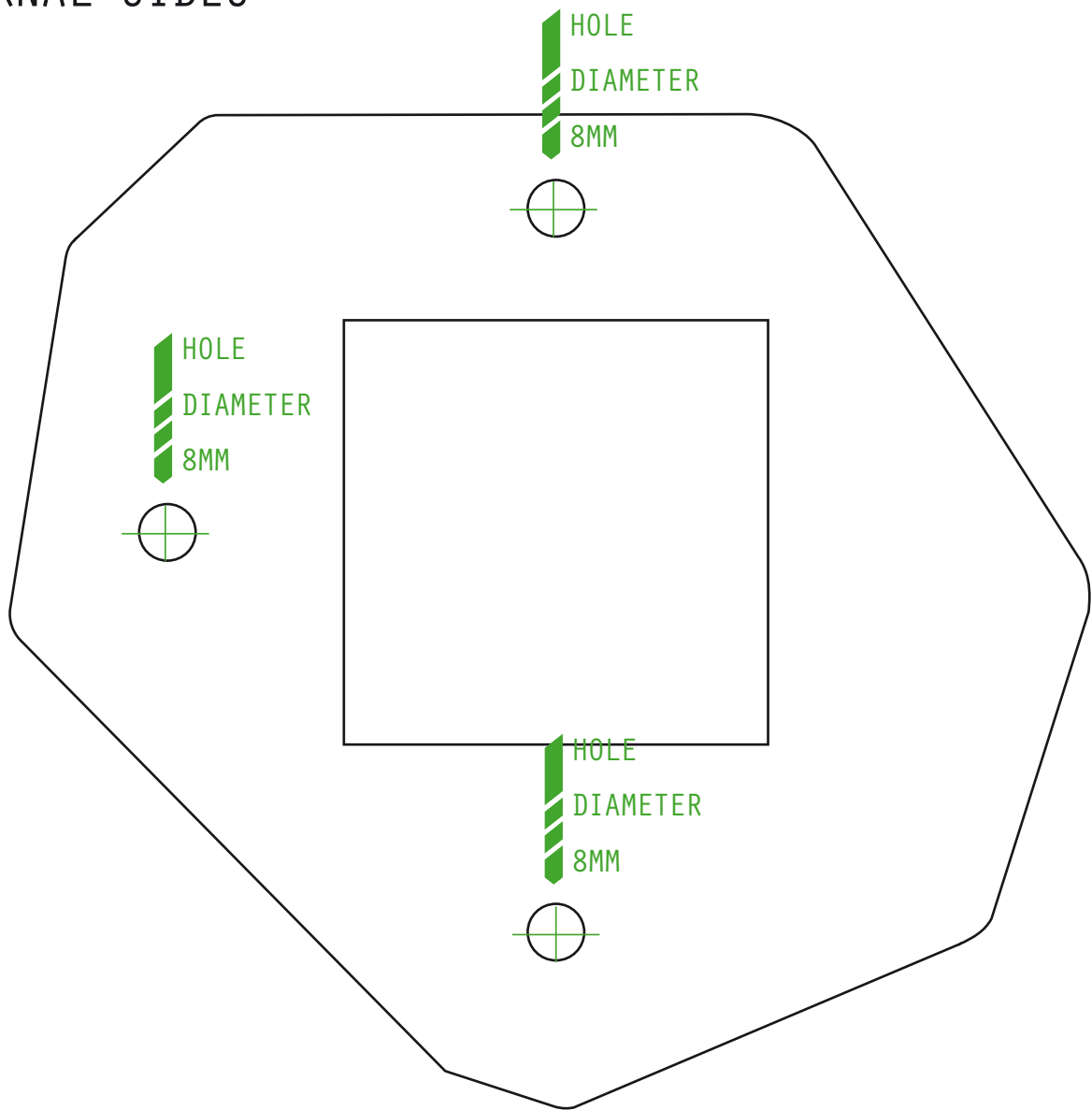

PLAN 5

INTERNAL SIDES

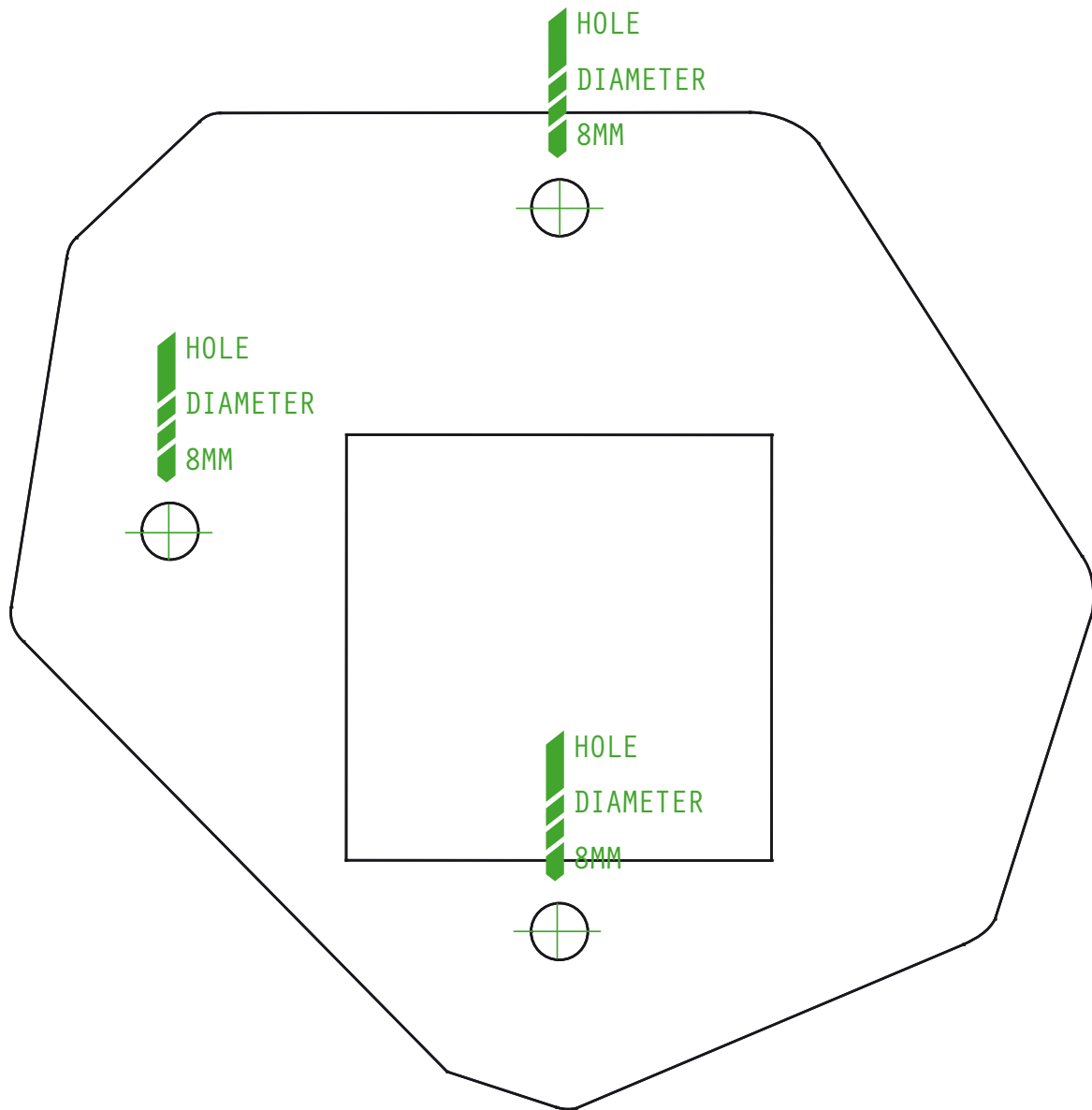

INTERNAL SIDES

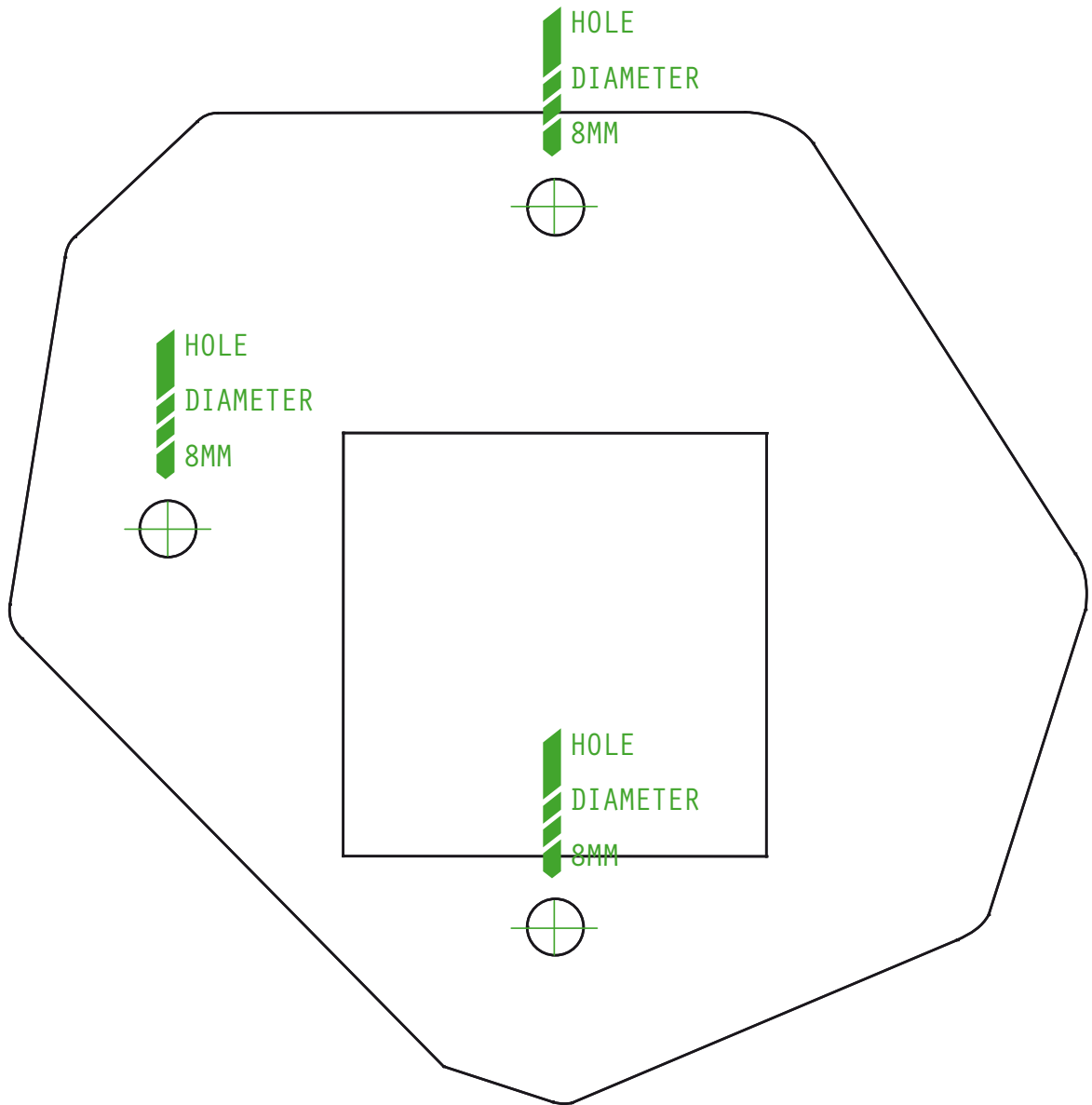

PLAN 2

DEPENDING ON YOUR PERSONAL HEIGHT CHOOSE THE SIZE RANGE THAT'S MORE SUITS YOU FROM THE DOTTED OUTLINES

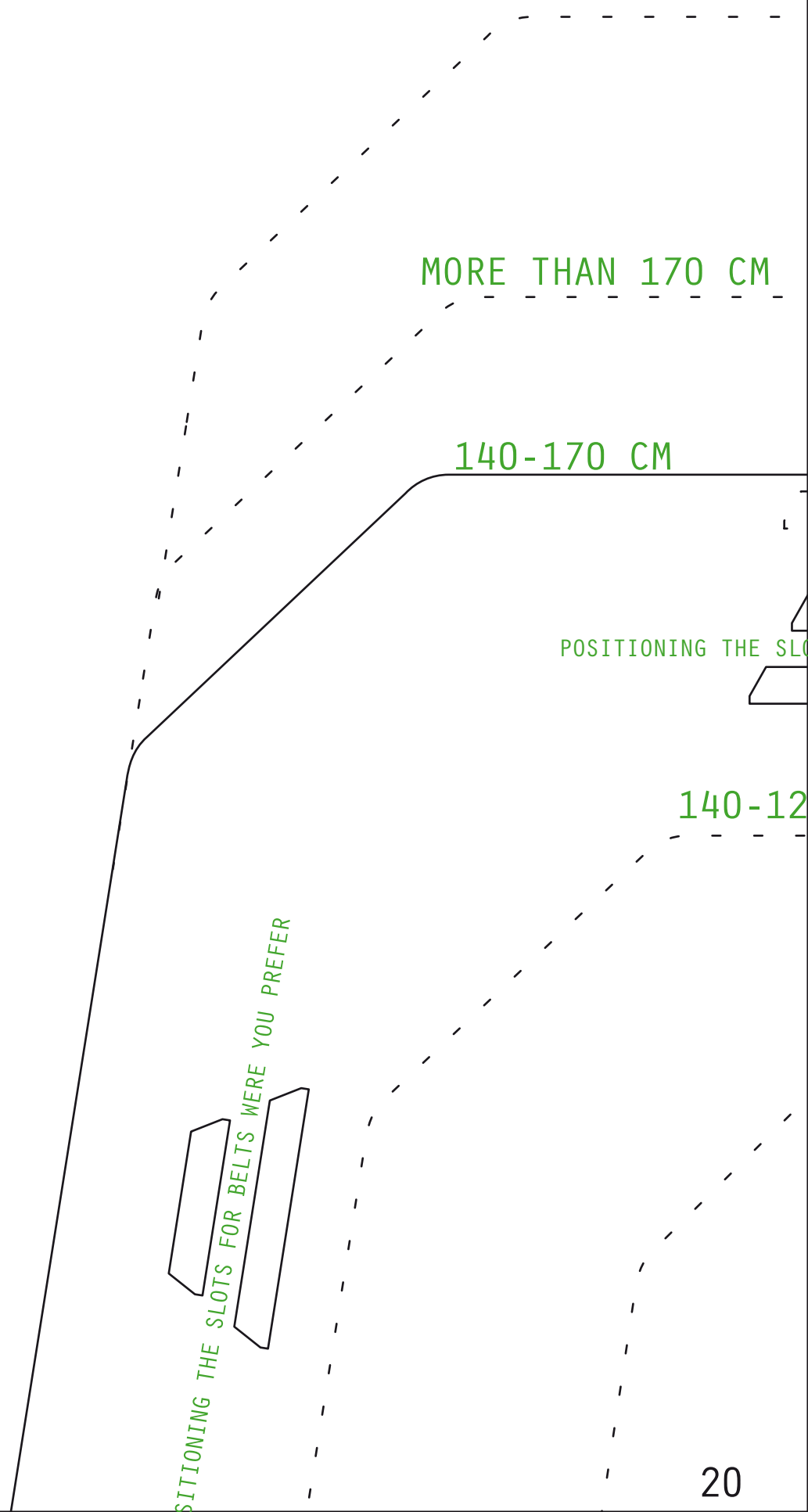

POINTS FOR BELTS WERE YOU PREFER

0 CM

120-80 CM

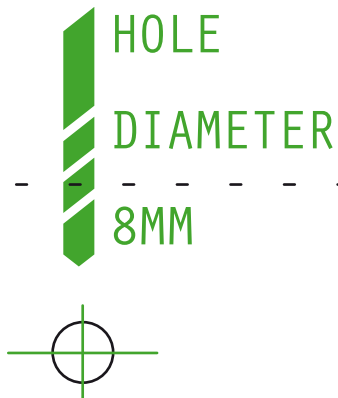

POSITIONING THE SLOTS

FOR BELTS WERE YOU PREFER

CENTRAL AXIS

HOLE
DIAMETER
8MM

HOLE
DIAMETER
8MM

HOLE
DIAMETER
8MM

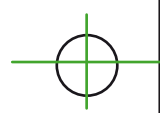

OLE
AMETER
IM

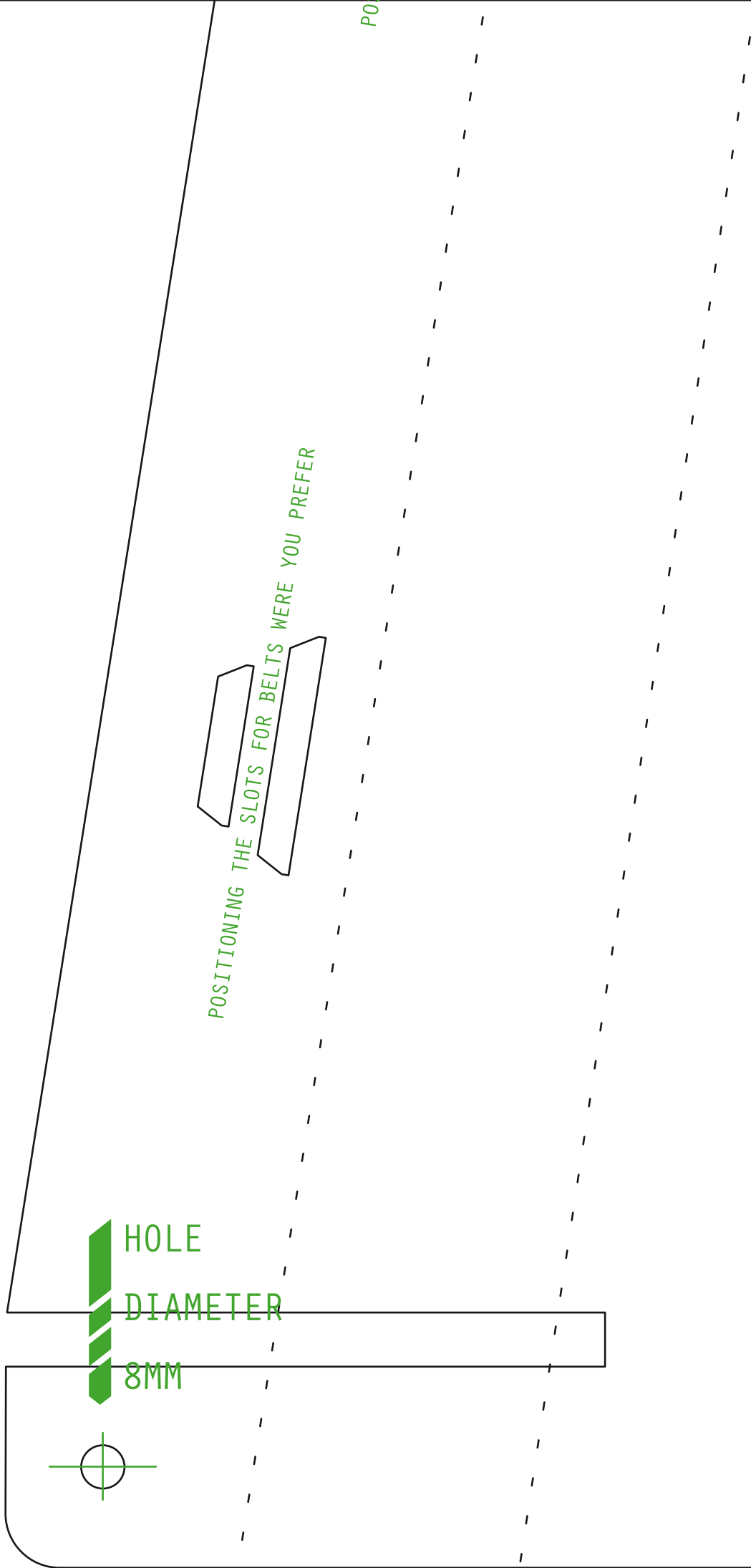

POSITIONING THE SLOTS FOR BELTS WERE YOU PREFER

HOLE
DIAMETER
8MM

P0

HOLE
DIAMETER
8MM

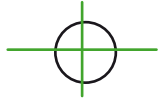

HOLE
DIAMETER
8MM

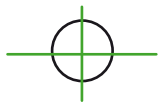

HOLE
DIAMETER
8MM



HOLE
DIAMETER
8MM



PLAN 6

EXTERNAL SIDE

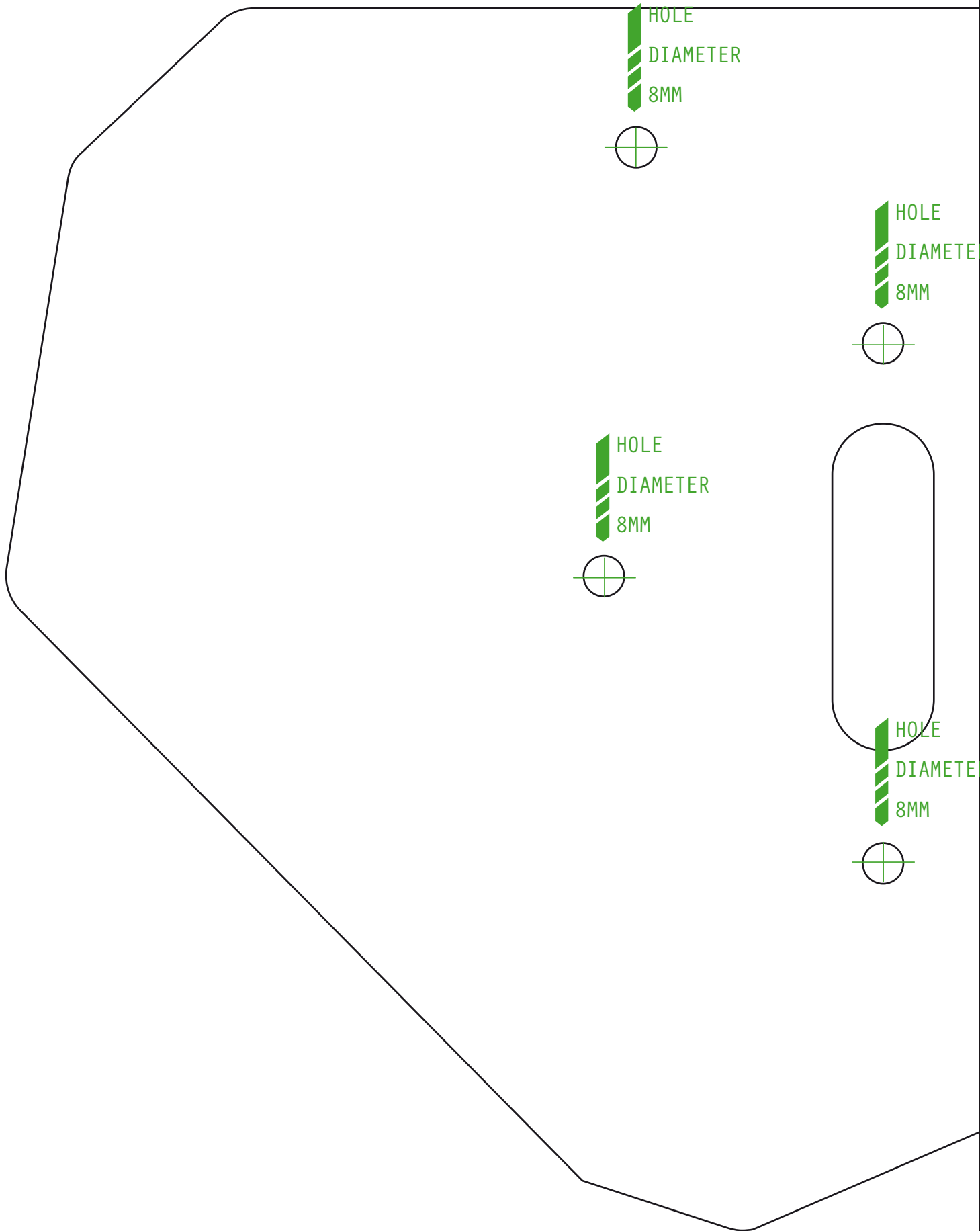

INTERNAL SIDE

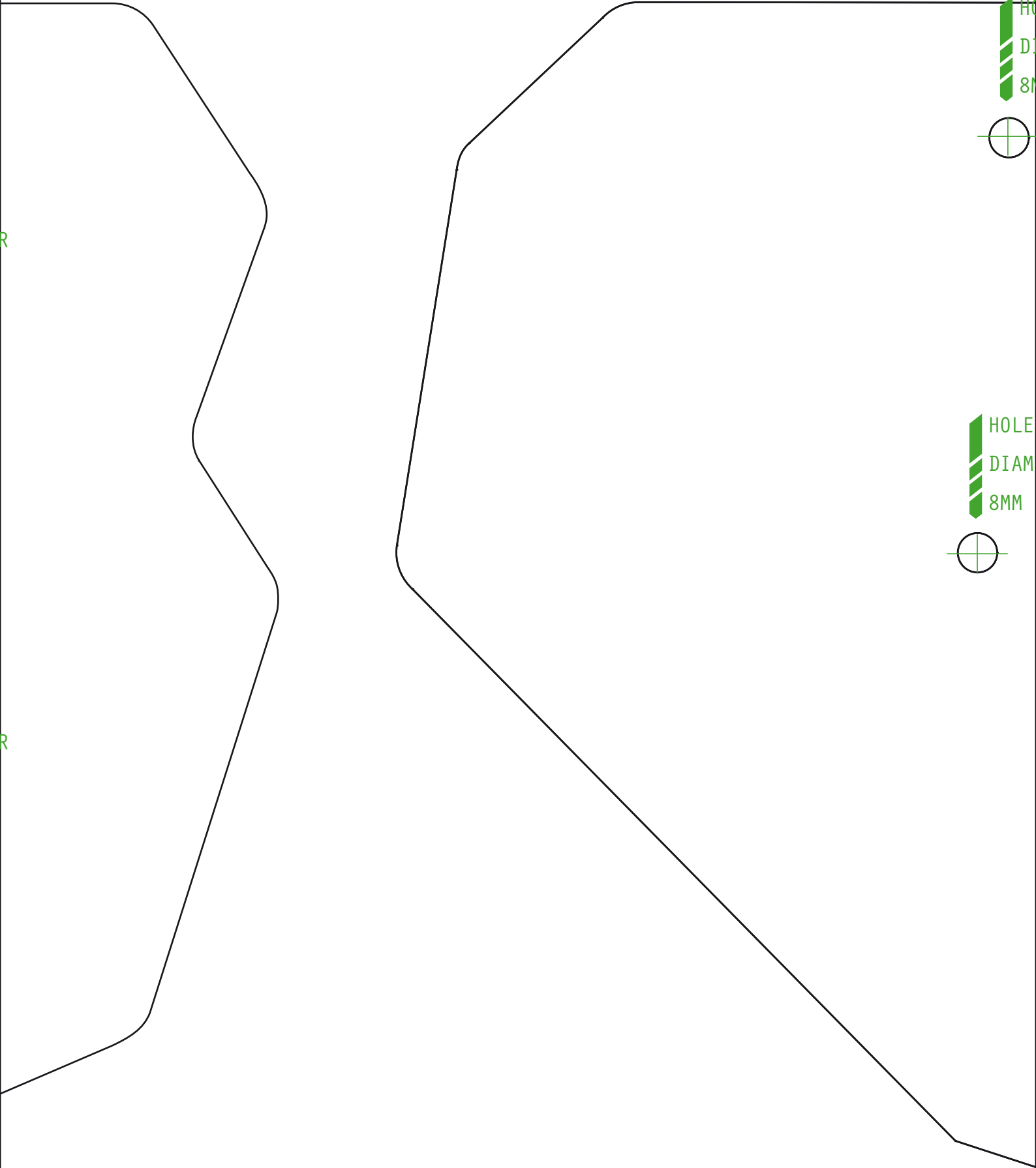

INTERNAL SIDE

HOLE
DIAMETER
8MM

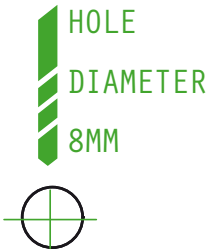

HOLE
DIAMETER

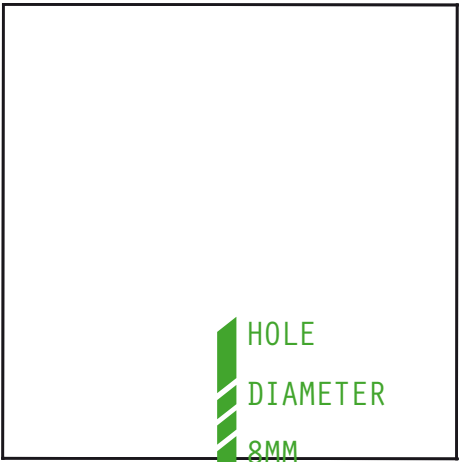

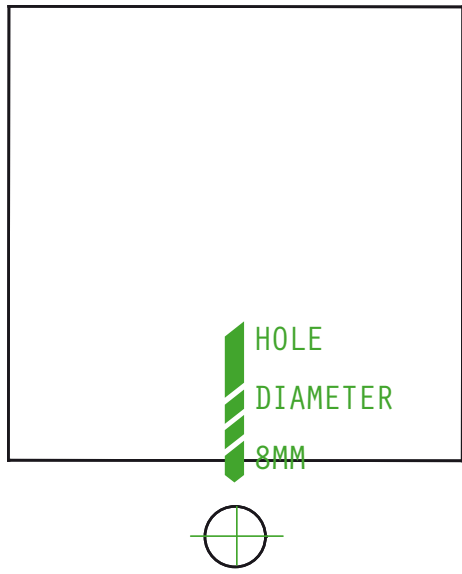
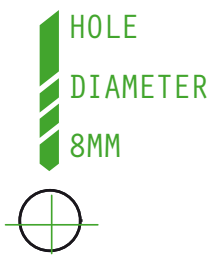
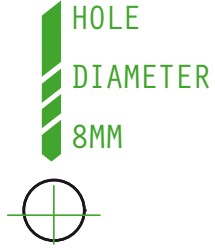
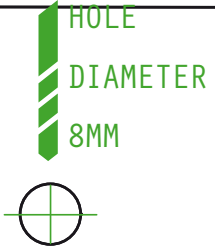

PLAN 7

EXTERNAL SIDE

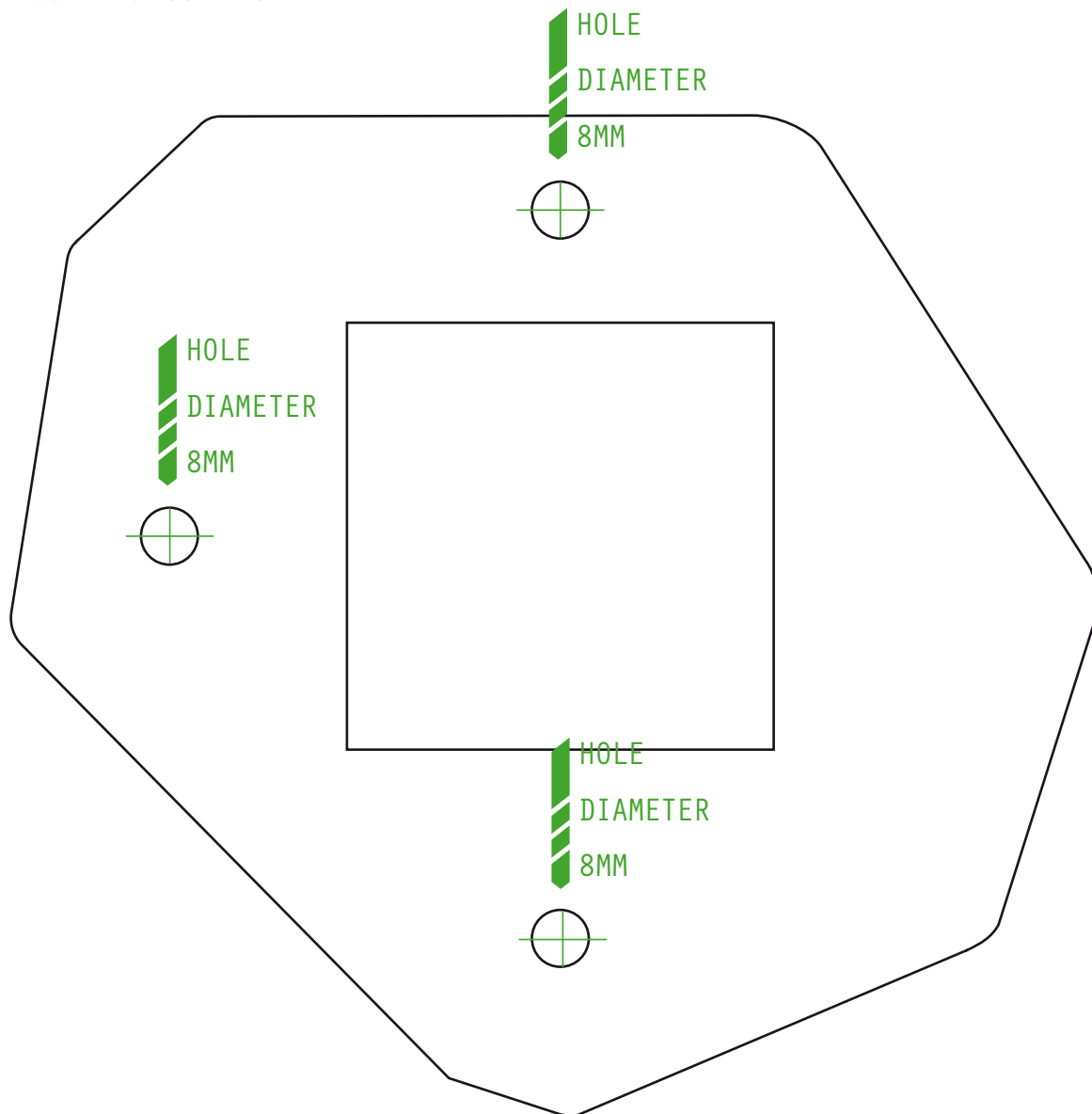

EXTERNAL SIDE

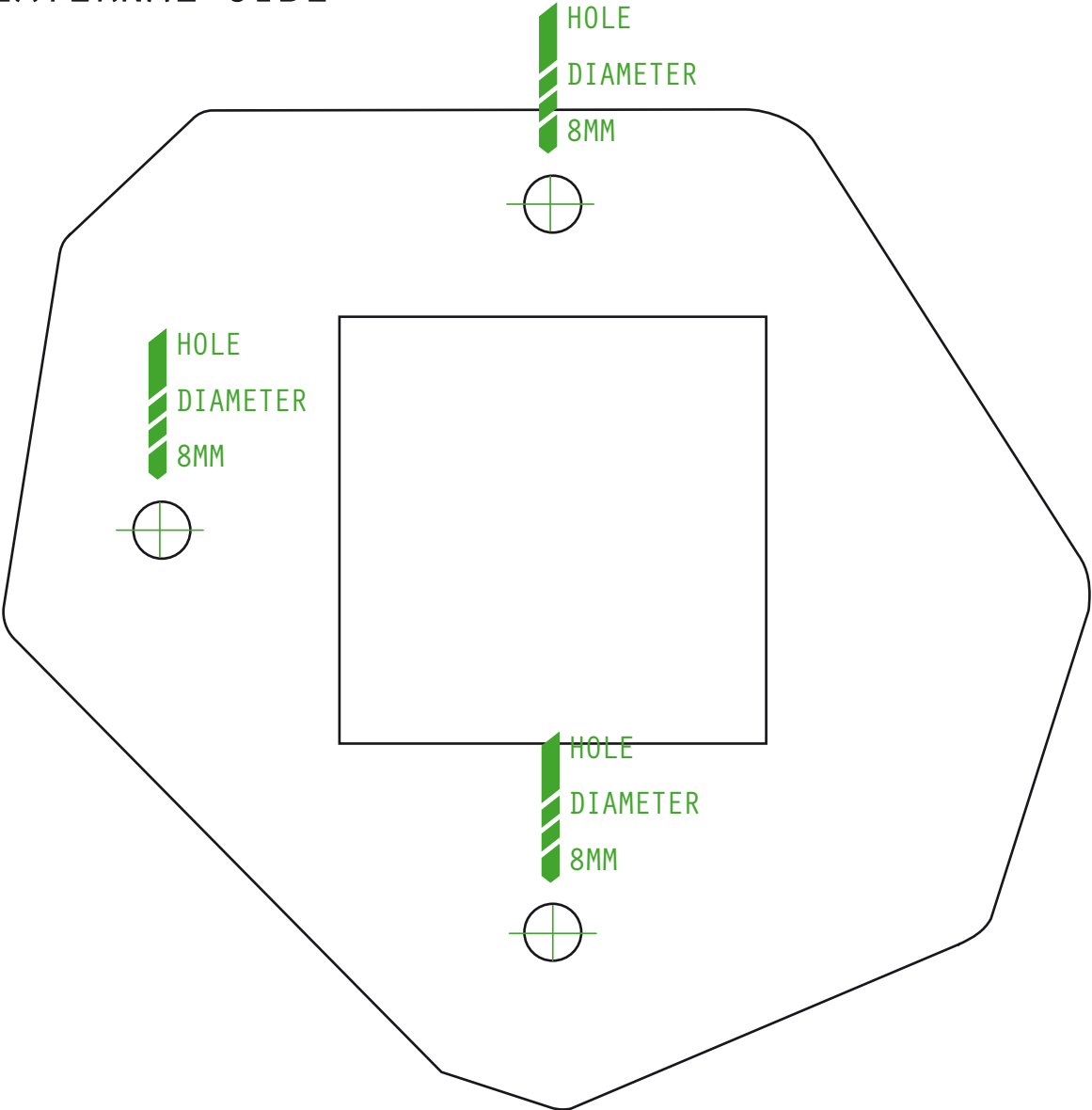

SEAT

SEAT

ITS WIDTH IS THE SAME OF YOUR **A** MEASURE AND ITS DEPTH IS THE SAME OF THE MEASURE **B - 10CM**. IF YOU WANT TO HAVE DIFFERENT SHAPER FOR EXTRA ERGONOMICS, CUT OFF SOME PART AND DESIGN YOUR REQUIRED SHAPES. THE DOTTED OUTLINE CAN BE AN EXAMPLE.

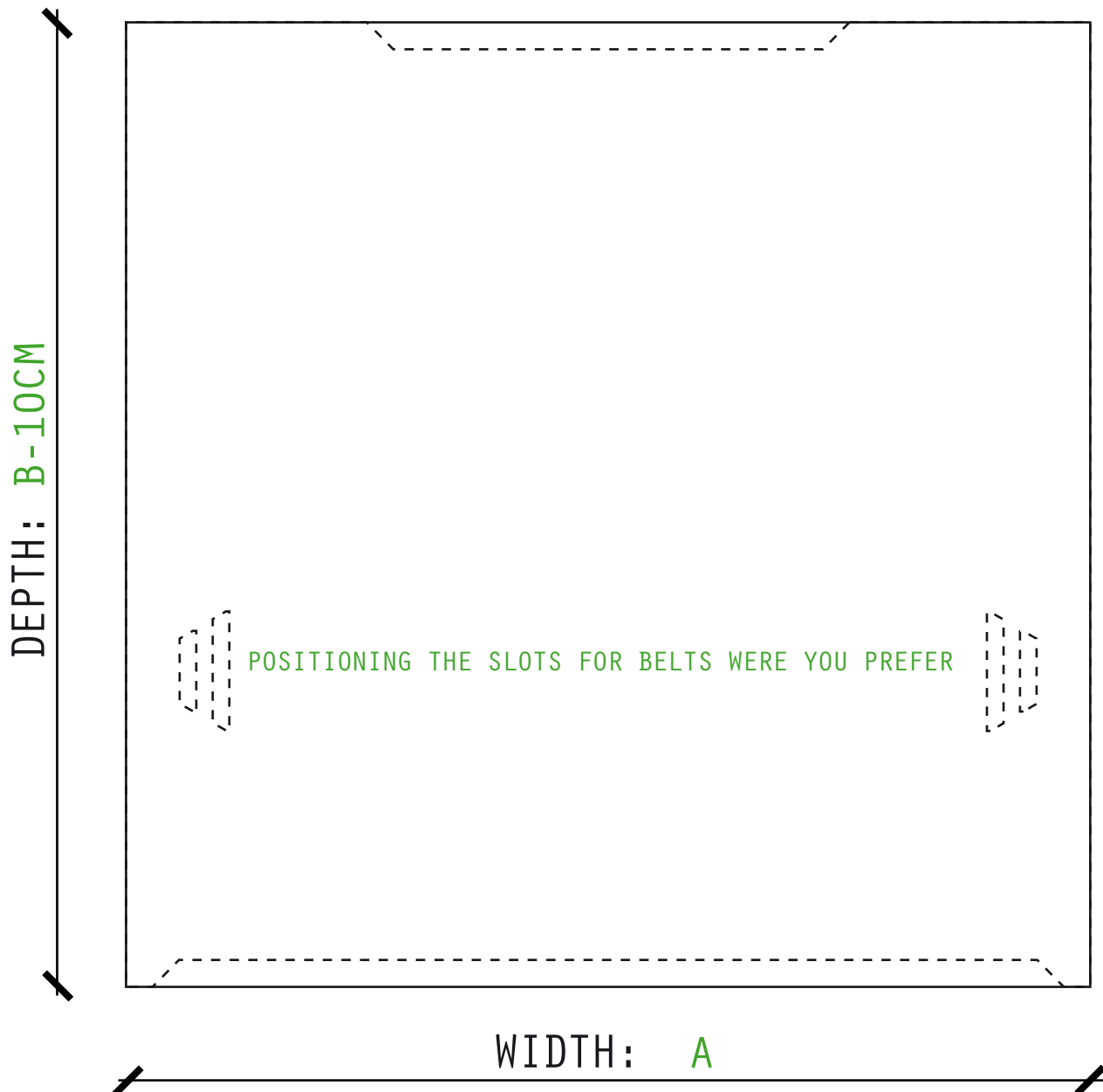

BACKREST

BACKREST

THE BACKREST WIDTH IS GIVEN BY THE A MEASURE, ITS HEIGHT FROM THE C MEASURE. FOR A BETTER COMFORT, YOU CAN CUT OFF SOME PARTS AND DESIGN YOUR REQUIRED SHAPES.

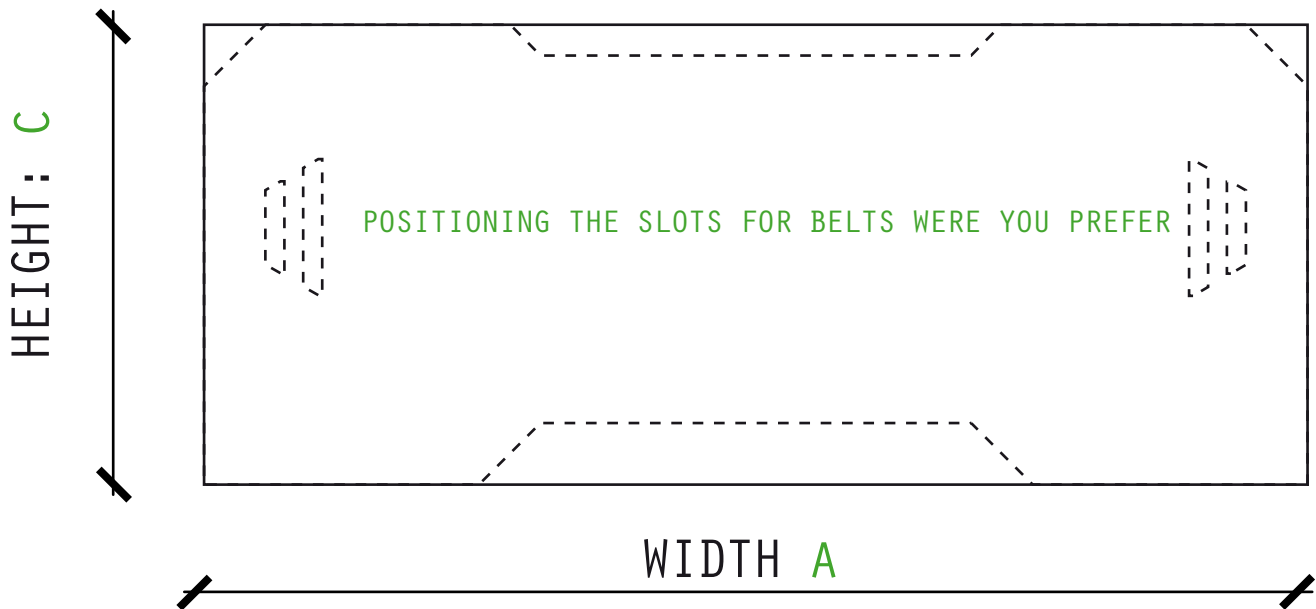

HORIZONTAL PANEL

POGGIAPIEDI

THE WITH OF THIS PIECE IS YOUR **A** MEASURE, HIS HIGHT IS **20CM**.

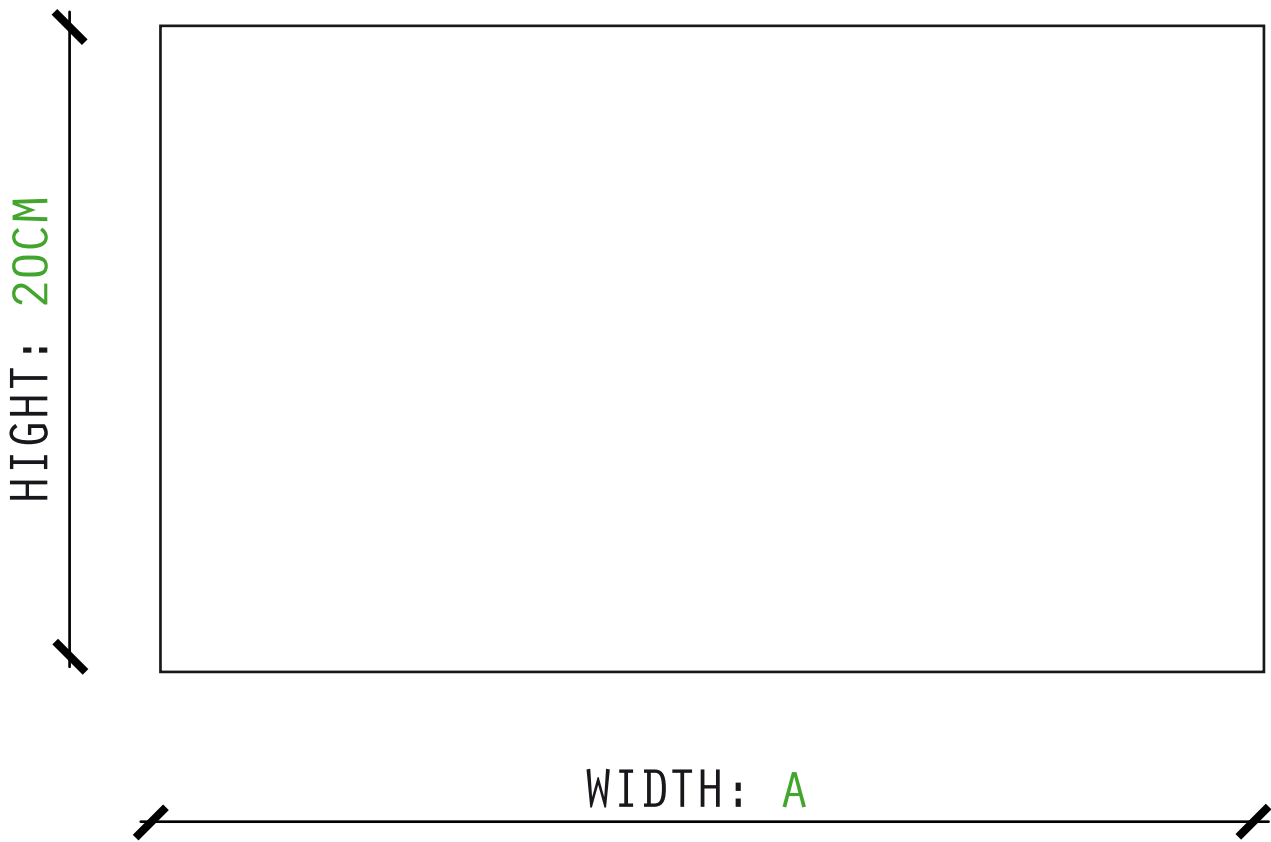

AXLE'S WEDGE

SECTION AA'

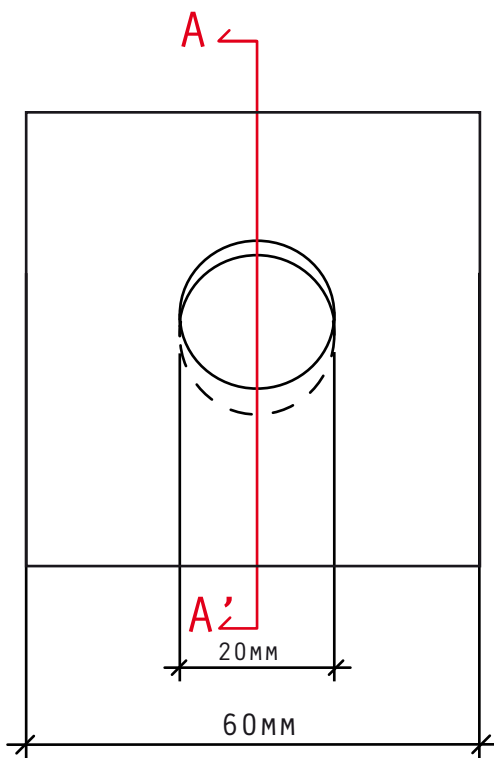
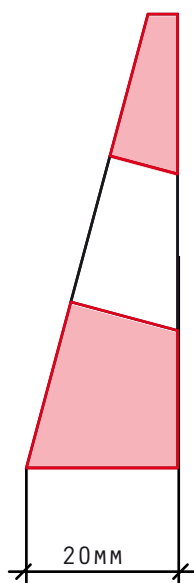

THE AXLE'S WEDGE ALLOW YOU TO HAVE THE DESIRED ANGLE OF THE WHEELS. YOU CAN CUT FROM WOOD OR 3D PRINT, BUT BE SHURE YOUR MATERIAL IS STRONG ENOUGH!

YOU CAN CHANGE THE ANGLE OF THE WEDGE FOR DIFFERENT WHEELS INCLINATION, OR IF YOU WANT VERTICAL WHEELS FOR EVERYDAY USE YOU CAN MAKE THE FACES OF THE WEDGE PARALLEL, WITH THE HOLE PERPENDICULAR AT THE FACES.

HUB'S FLANGE

FASE 8

CUT THIS OUTLINES AND FIX ON YOUR METAL SHEET. DRILL THE HOLE WITH THE INDICATED DIAMETER BIT. BE CAREFUL TO SMOOTH ALL THE SURFACES TO AVOID CUTS AND SCRATCHES!

