



4 X 100Watt Class D Audio Amplifier Board – T-AMP User's Guide

4 X 100Watt Class D Audio Amplifier Board – T-AMP

Note:

Please read this manual carefully before you use the product. To keep the product in a best working condition and having a long service time, please operate it according to the relevant steps. The warranty lapses if the product is damaged because of incorrect use and your negligence.

Please read this manual carefully before you use the product and check if the product is a good one. DC36V is recommended to be used to power the product for one hour. Please make sure there's space for heat dissipation since this product outputs high power and don't touch the heat sink with your hand. Never use this product in an extreme condition.

Warning: Never immerse the product in the rain or any other humid environment to prevent the fire or electric shock.

Safety Precautions:

1. In order to achieve a better sound quality, please use stable power supply since a bad or unstable power supply may worsen the sound quality or even cripple the amplifier board.
2. Avoid metal objects. Protect this product well and move away metal objects from this product.



4 X 100WATT CLASS D AUDIO AMPLIFIER BOARD - T-AMP USER'S GUIDE

Table of Contents

Chapter 1. Overview	1
1.1 Overview	1
1.2 Accessories	1
1.3 Features	2
1.4 Applications.....	2
1.5 Benefits	2
1.6 Quick Start	2
Chapter 2. Hardware Detail	4
2.1 Power Connection.....	4
2.2 Input Connections.....	5
2.3 Output Connections.....	5
2.4 DC Offset.....	6
2.5 LED Indicators.....	6
2.6 Volume Control.....	7
2.7 Notes	7
Chapter 3. Electrical Characteristics	8
Chapter 4. Mechanical Drawing.....	9
Chapter 5. Contact Us	10

4 X 100Watt Class D Audio Amplifier Board - T-AMP

NOTES:

Product Version : **Ver 2.2**

Document Version : **Ver 1.0**

Chapter 1. Overview

1.1 Overview

Welcome to use this self-made 4*100W audio amplifier board which is a perfect class-D architecture integrated with Tripath's high performance TC2000 and TP2050 chips supporting dual channel audio amplification. Powered by any DC voltage from 10V to 30V, this high efficiency amplifier board is capable of outputting up to 100W per channel. It can be used to drive 4Ω or 8Ω passive speakers. With high efficiency, it especially is available for the outdoor venues where power supply is always in consideration.

TC2000 is a dual channel audio controller produced by Tripath using its patent Digital Power Processing technology (DPP™). Combined with switching power output stages TP2050, it can achieve class-T audio power amplification, as well as lower THD+N and higher S/N ratio.

For 100W power output, this amplifier board integrates one TC2000 chips and two TP2050 chips so that it supports dual-channel audio amplification of up to 100W each. Resistance and capacity components of high quality are used to gain the perfect timber, finally realize high S/N ratio, low THD+N, wide frequency response range etc.

FIGURE 1-1 OVERVIEW

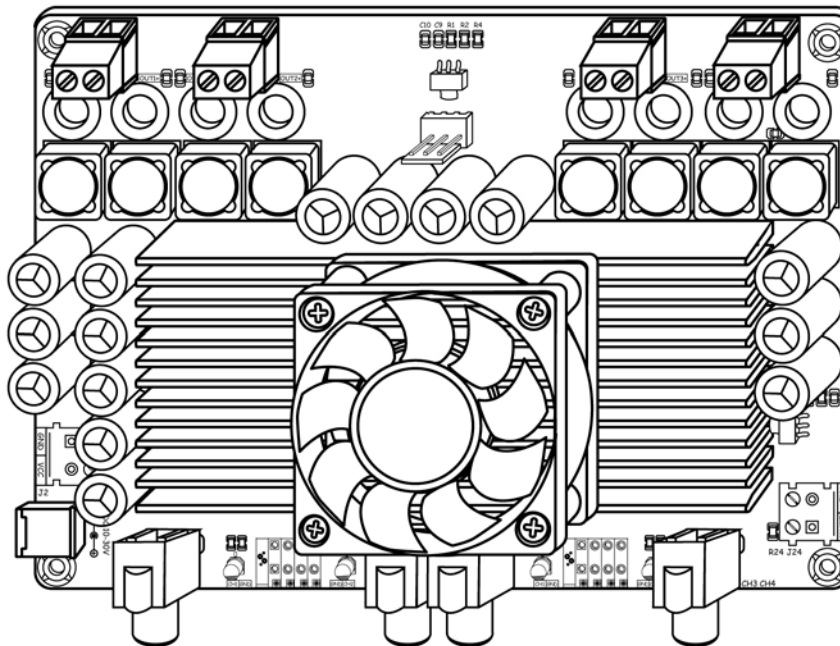

Note: All the diagrams in this manual are for reference only.

1.2 Accessories

We don't provide audio accessories together with this product. Please go to www.sure-electronics.com to choose what you need.

4 X 100Watt Class D Audio Amplifier Board - T-AMP

1.3 Features

- A perfect "Class D" architecture
- Frequency response: 20Hz to 20KHz(± 3 dB)
- Single end audio signal input
- Over/under voltage protection
- Over current protection
- Over temperature protection

1.4 Applications

It is the ideal solution for any sound reinforcement installation or application needing an affordable compact PA system.

- Background Music Systems
- Vending Machine
- Lifts
- Interactive Kiosks
- Home DIY
- Car audio

1.5 Benefits

- Mounting holes facilitate installation and fixing
- Several wiring methods facilitate connection: RCA Socket (Default), Terminal Block(Optional)
- Excellent design of the power ports which allows you to connect multiple amplifier boards in series (Terminal Block Optional).
- Excellent heat dissipation eliminates the requirement of an extra heat sink.

1.6 Quick Start

Suggested connection is shown in figure 1-3.

FIGURE 1-2 CONNECTION SCHEMATIC

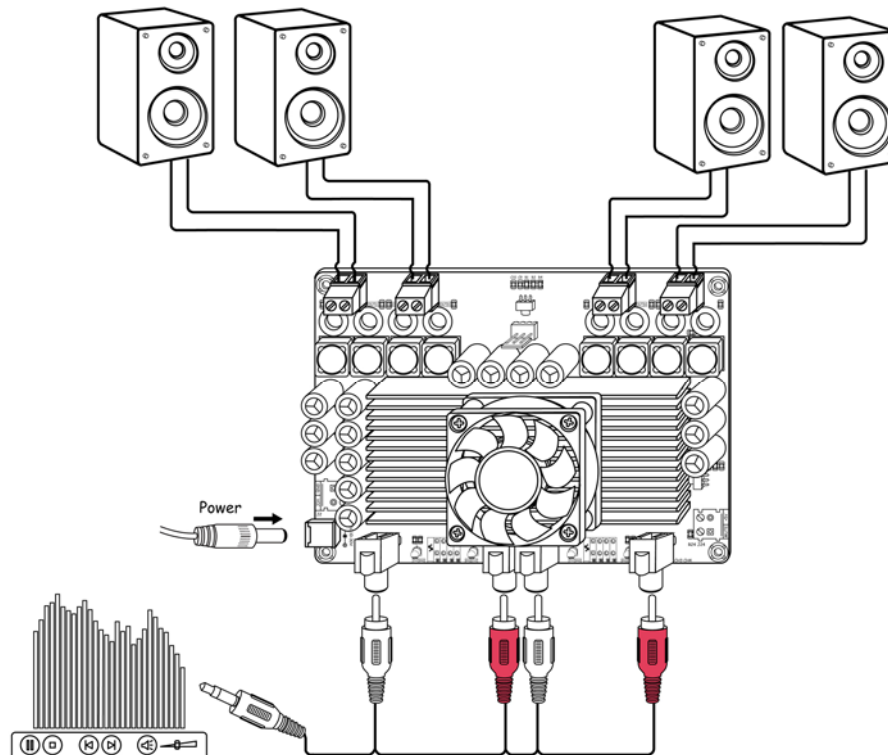

Note: Please observe the following steps to complete verification so as to ensure the products are intact during transit.

1. Open the amplifier package and make sure the product is intact (No missing or damaged components and no deformation).
2. Please observe the connection schematics when connecting the amplifier board. Use a nearby sound source, such as MP3 or CD player to have a trial. This amplifier board can be deemed as qualified if you can hear the sound corresponding to that sound source

Chapter 2. Hardware Detail

2.1 Power Connection

To power the amplifier board, use either jack J3 (inner +, outer -) or terminal blocks J2 (optional). Pay attention to the polarity when connecting power supply.

FIGURE 2-1 POWER CONNECTION

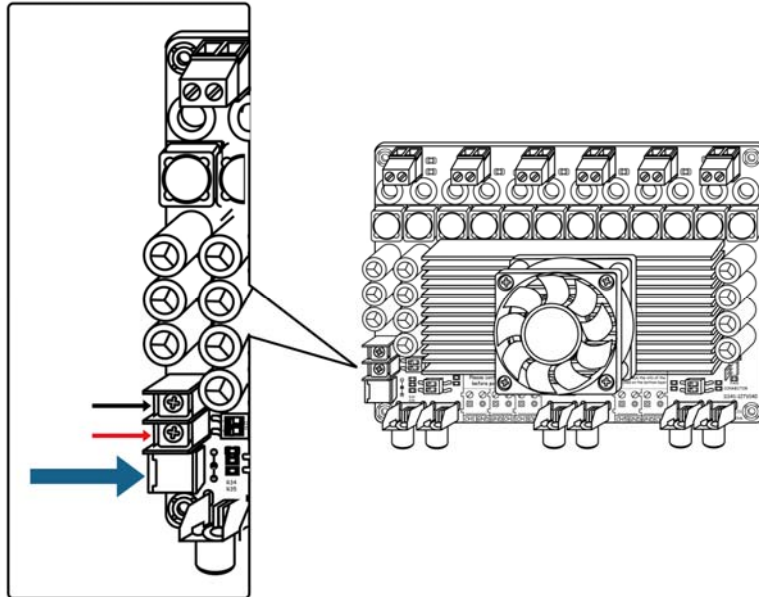

TABLE 2-1 POWER CONNECTION

Connector Mark		Description	
Jack	J3	DC 10-30V power supply socket	
Terminal Blocks	J2	VCC	The positive of DC 10-30V power supply socket
		GND	The negative of DC 10-30V power supply socket

Note:

1. You are allowed to use only one way to power the amplifier board at a time.
2. The maximum supply voltage shall be referred to Chapter 3.
3. [27V Switching power supply](#) is recommended.

4 X 100Watt Class D Audio Amplifier Board - T-AMP

2.2 Input Connections

You may use RCA connectors to input audio signal.

FIGURE 2-2 INPUT CONNECTION

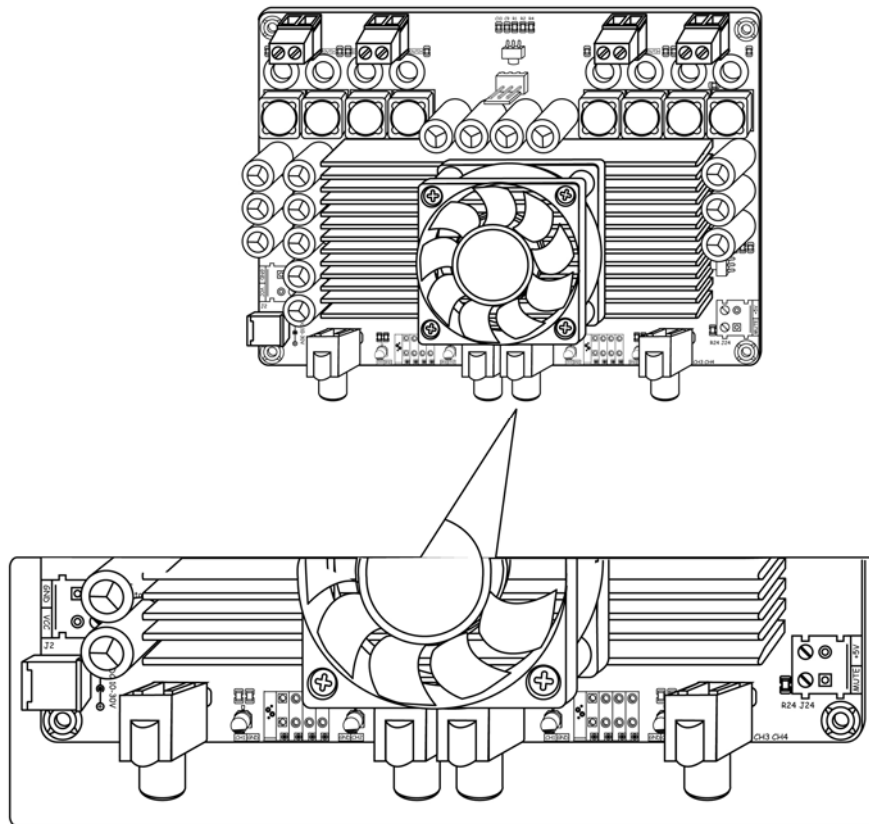

TABLE 2-2 INPUT CONNECTION

Connector Mark	Channel Description
RCA connector	J17 Channel 1 Input
	J19 Channel 2 Input
	J21 Channel 3 Input
	J23 Channel 4 Input

Warning:

1. For each group (dual channels), RCA and Terminal Blocks can not be used as input connectors at the same time.
2. Never plug in or unplug RCA connectors when the amplifier is powered. Or the amplifier will be damaged permanently.
3. Only the same signal is allowed for each or two groups.

2.3 Output Connections

You can use either terminal blocks or banana connectors (optional) to output audio signal.

FIGURE 2-3 OUTPUT CONNECTION

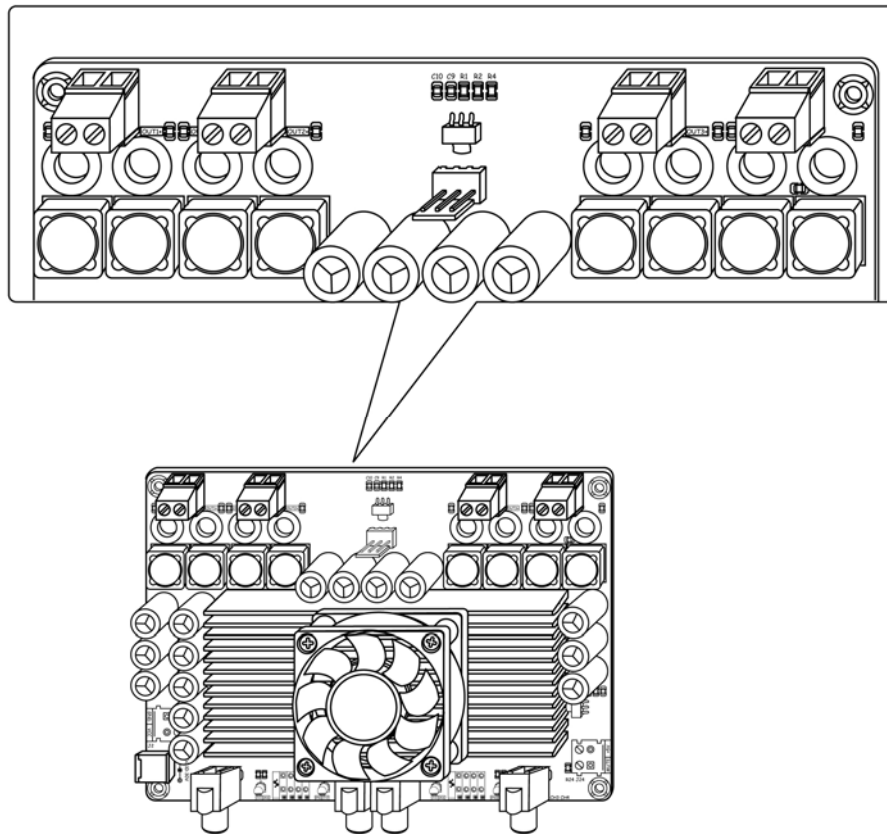

TABLE 2-3 OUTPUT CONNECTION

Connector Mark		Description
Terminal blocks*	J5	Output of Channel 1
	J8	Output of Channel 2
	J11	Output of Channel 3
	J14	Output of Channel 4

Note:

1. Never connect more than one group of speaker to the audio output
2. Never connect CH1_OUT- ,CH2_OUT- together since they belong to different NETs.
3. Refer to on-board descriptions for connection details.

2.4 DC Offset

If it is not quite necessary, DO NOT trim the output offset by adjusting “R51”, “R56”, “R61” and “R65” on the board since the output offset has been regulated to a range of $\pm 10\text{mV}$.

Note: Never adjust these potentiometers unless necessary, improper adjustment may damage your speakers.

2.5 LED Indicators

This amplifier has 1 power LED indicator which is marked as “Power Indicator (D1)”. “Power Indicator (D1)” will be illuminated in green when power-up.

4 X 100Watt Class D Audio Amplifier Board - T-AMP

FIGURE 2-4 LED INDICATOR

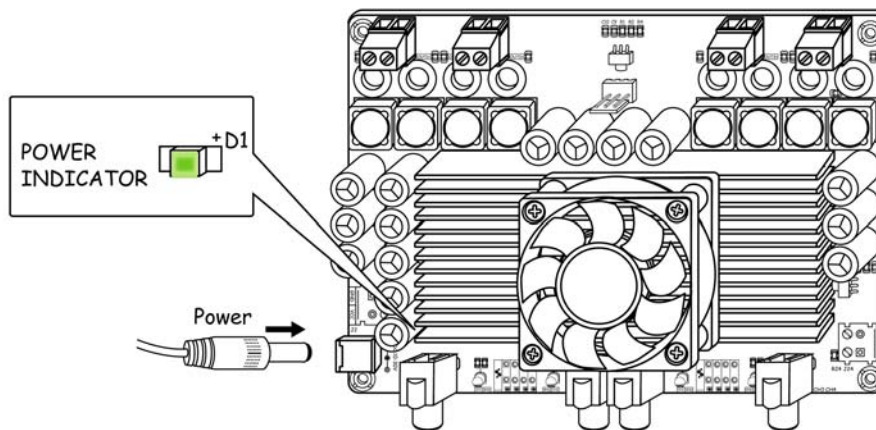

2.6 Volume Control

No potentiometer is provided for manually adjusting the volume. The volume control of sound source like MP3 or PC can be used to adjust the volume of the audio output or a 50K Ω potentiometer can be installed by users themselves, which may cause signal attenuation.

Please be aware that audio clippings may occur to some portable players because of the audio source not the amplifier itself. The sensitivity of this amplifier is 0.520VRMS and the audio signal of the same level should be input.

2.7 Notes

In order to protect amplifier board and extend its service lifetime, please read the following warnings carefully since warranties will be voided if you do not observe the following warnings:

Warning 1:

Quality-related issues caused by potentiometers installed by buyers.

Warning 2:

In order to achieve a better sound quality, please use stable power supply since a bad or unstable power supply may worsen the sound quality or even cripple the amplifier board.

Warning 3:

Never equip a pre-amplifier to the audio input since the amplifier itself has powerful amplification ability and a high signal input will burn out the amplifier chip.

Warning 4:

In order to protect amplifier and speaker, please turn the volume output to the minimum when hooking up the amplifier and you may readjust the volume when you are sure that the amplifier is functioning properly.

Chapter 3. Electrical Characteristics

Following table lists all typical data of the Amp board. Stresses beyond the power supply range maximum ratings may cause permanent damage.

TABLE 3-1 ELECTRICAL CHARACTERISTICS

Parameter	Condition	Min.	Typ.	Max.
Supply Voltage	-	10V	27V	30V
Input Sensitivity	Pout=100w	-	520mV	-
Quiescent Power (W)	Vmute=0V VCC=30V	-	12.6	-
Standby Power (W)	Vmute=5V VCC=30V	-	6.6	-
Efficiency	Pout=100W	-	90.3%	-
Input Impedance	-	-	10K ohm	-
Output Power	1% THD+N	RL=4 ohm, VCC=30V	64W	-
	10% THD+N		108W	
Frequency Response	VCC=30V	-3dB	1.01dB	3dB
Load	-	3.2 ohm	4 ohm	-
Gain	-	-	32dB	-
Operating Temperature	-	0°C	20°C	70°C
Storage Temperature	-	-20°C	20°C	105°C
Thermal Shutdown	-	-	150°C	-

Note:

1. Stresses beyond the listed maximum power supply voltage may cause the permanent damage to components on board.
2. The input sensitivity values are calculated on the basis of 6 Ohm load.

Chapter 4. Mechanical Drawing

FIGURE 4-1 MECHANICAL DRAWING

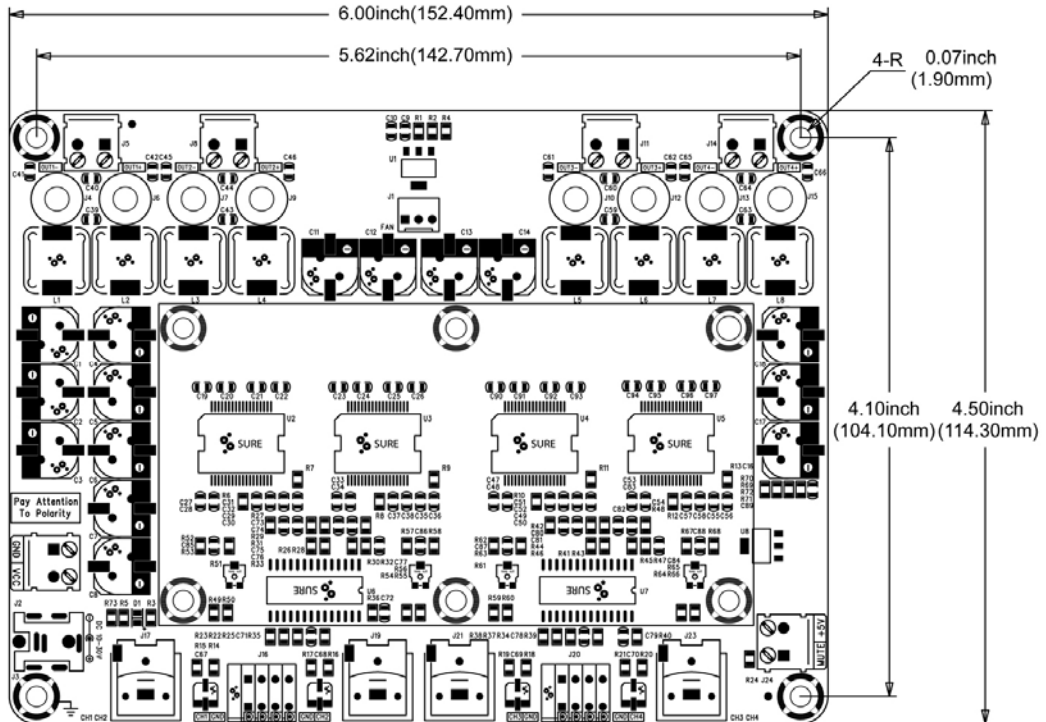



4 X 100WATT CLASS D AUDIO AMPLIFIER BOARD - T-AMP USER'S GUIDE

Chapter 5. Contact Us

Sure Electronics Co., Ltd.

East zone, 3F, Building 6
Jingang Technology Innovation Center
No.108 Ganjiabian Rd (ZIP: 210000)
Qixia District
Nanjing
P.R.China

Tel: +86-25-68154800-860

Fax: +86-25-68154891-832

Website: www.sure-electronics.com

Email: customerservice@sure-electronics.com