

VIEW Front

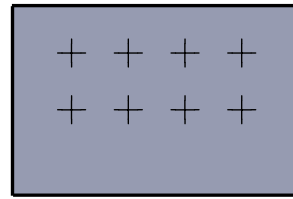

VIEW Front

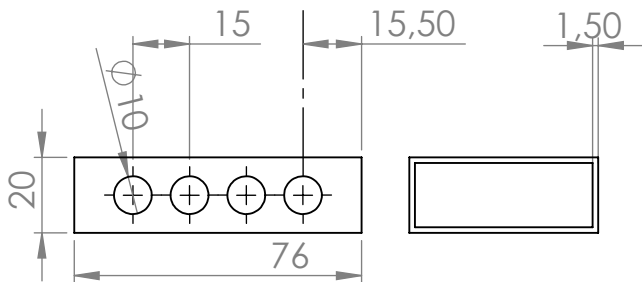

VIEW Top

VIEW Side

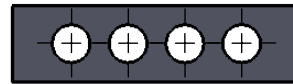

VIEW Top



VIEW Side

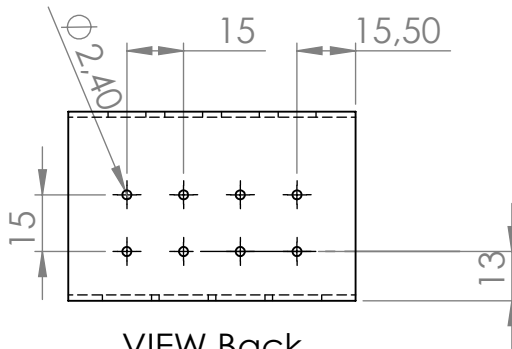

VIEW Back

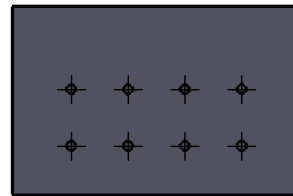

VIEW Back

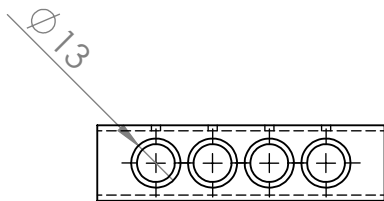

VIEW Bottom

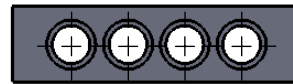

VIEW Bottom

UNLESS OTHERWISE SPECIFIED:
DIMENSIONS ARE IN MILLIMETERS
SURFACE FINISH:
TOLERANCES:
LINEAR:
ANGULAR:

FINISH:

DEBUR AND
BREAK SHARP
EDGES

DO NOT SCALE DRAWING

REVISION

	NAME	SIGNATURE	DATE		
DRAWN					
CHK'D					
APPV'D					
MFG					
Q.A				MATERIAL:	
				WEIGHT:	

TITLE:	
DWG NO:	Haptic_input_frame ^{A4}
SCALE:1:2	SHEET 1 OF 1