



# MediaTek LinkIt™ Smart 7688 Developer's Guide

Version: 1.1

Release date: 22nd February 2016

Specifications are subject to change without notice.

© 2015, 2016 MediaTek Inc.

This document contains information that is proprietary to MediaTek Inc.  
Unauthorized reproduction of this information in whole or in part is strictly prohibited.

## Document Revision History

---

Revision	Date	Description
1.0	1 <sup>st</sup> December 2015	Initial Release
1.1	22 <sup>nd</sup> February	Updated instructions of installing the Arduino PyMata Sketch in 6.6.5, "PyMata Approach".

# Table of contents

---

<b>1.</b>	<b>Introduction</b> .....	<b>1</b>
1.1.	What is MediaTek LinkIt? .....	1
1.2.	What is MediaTek LinkIt Smart 7688 Development Platform .....	1
1.3.	Hardware Development Kits .....	1
1.4.	Programming Environment .....	1
1.5.	Software Development Tool .....	1
1.6.	Get Started .....	2
1.7.	More Information .....	2
1.8.	Join the MediaTek Labs Ecosystem .....	3
<b>2.</b>	<b>Hardware Development Kit</b> .....	<b>4</b>
2.1.	MediaTek MT7688AN Chip Specification Summary .....	4
2.2.	LinkIt Smart 7688 .....	5
2.3.	LinkIt Smart 7688 Duo .....	15
2.4.	FCC, CE and NCC Certifications .....	22
<b>3.</b>	<b>Programming Environment Guide</b> .....	<b>23</b>
3.1.	Platform operating system .....	23
3.2.	Programming Environment Overview .....	23
3.3.	Programming Model for Different Boards .....	24
3.4.	Network Environment .....	25
3.5.	Programming in C/C++ .....	26
3.6.	Programming in Python .....	27
3.7.	Programming in Node.js .....	28
<b>4.</b>	<b>Software and Tools</b> .....	<b>31</b>
4.1.	Software and Tools .....	31
4.2.	Supported Host Environments .....	31
4.3.	Default OpenWrt Packages .....	32
4.4.	OPKG Package Manager .....	32
4.5.	System Configuration .....	33
4.6.	System Configuration tasks .....	44
4.7.	File Editor and Transfer .....	53
<b>5.</b>	<b>Peripheral Programming on LinkIt Smart 7688</b> .....	<b>59</b>
5.1.	How to Access LinkIt Smart 7688 Peripheral using MRAA .....	59
5.2.	How to use UPM to access sensors and peripherals .....	66
<b>6.</b>	<b>Peripheral Programming on LinkIt Smart 7688 Duo</b> .....	<b>67</b>
6.1.	Installing Arduino IDE .....	67
6.2.	Installing Board Support Package .....	67
6.3.	Installing LinkIt Smart 7688 Duo COM Port Driver .....	71
6.4.	Programming model for LinkIt Smart 7688 Duo .....	72
6.5.	Programming with Primitive UART Connection .....	75
6.6.	Programming with Firmata Protocol .....	77
6.7.	Programming with Yun Bridge Library .....	89
<b>7.</b>	<b>How to Build Firmware and Bootloader</b> .....	<b>91</b>
7.1.	Building a firmware .....	91
7.2.	Building a bootloader .....	92
<b>8.</b>	<b>Troubleshooting Guide</b> .....	<b>94</b>
8.1.	My firmware upgrade won't start or failed. Why? .....	94
8.2.	I can't connect to URL mylinkit.local using a browser, why is that? .....	94

8.3. My virtual machine cannot detect the board with mylinkit.local, why? ..... 95

8.4. I'm not able to SSH access with an error showing "Host Identification Has Changed",  
what can I do? ..... 95

8.5. There are multiple LinkIt Smart 7688 APs nearby and I'm not sure which one is mine,  
how do I find out?.....97

8.6. My onboard flash is very slow and seems broken, why? .....97

8.7. Why did my board failed to start up due to corrupted file system? ..... 98

8.8. What can I do if my onboard flash is full? ..... 98

8.9. Why is my I2C device not working? ..... 98

8.10. Why does my board keep rebooting when driving a servo? ..... 98

**Appendix A            Federal Communication Commission Interference Statement..... 99**

## Lists of tables and figures

---

Table 1 MT7688AN SOC Specification.....	4
Table 2 LinkIt Smart 7688 Development board buttons.....	6
Table 3 Wi-Fi LED blink pattern in LinkIt Smart 7688 HDK.....	7
Table 4 Typical power consumption scenarios.....	8
Table 5 LinkIt Smart 7688 development boards specifications.....	13
Table 6 LinkIt Smart 7688 Duo Development board buttons.....	16
Table 7 Typical power consumption scenarios.....	17
Table 8 LinkIt Smart 7688 Duo development board specifications.....	20
Table 9 LinkIt Smart 7688 Programming Environment Overview.....	24
Table 10 OS Capabilities.....	31
Table 11 Packages included in the LinkIt Smart 7688 development platform.....	32
Table 12 Configuration functions of the Web UI and System console.....	34
Table 13 USB and LinkIt Smart 7688 UART Pin Mapping.....	41
Table 14 Wi-Fi AP Encryption Type.....	50
Table 15 File Transfer Tools.....	53
Table 16 LinkIt Smart 7688 GPIO Pin Mapping.....	60
Table 17 MCU and MPU Communication.....	75
Table 18 Serial Pin Mapping Between MPU and MCU.....	78
Figure 1 LinkIt Smart 7688 development board (MPU only).....	5
Figure 2 Removing resistor to enable I-PEX connector.....	7
Figure 3 USB OTG cable.....	9
Figure 4 JTAG resistors on the bottom of the LinkIt Smart 7688.....	10
Figure 5 Moving a resistor to access JTAG mode.....	11
Figure 6 LinkIt Smart 7688 Pin-out Diagram.....	14
Figure 7 LinkIt Smart 7688 Duo development board (MPU + MCU).....	15
Figure 8 JTAG resistors on LinkIt Smart 7688 Duo bottom view.....	18
Figure 9 Moving a resistor to access JTAG mode.....	18
Figure 10 LinkIt Smart 7688 Duo Pin-out Diagram.....	21
Figure 11 Programming models for the LinkIt Smart 7688 development platform.....	24
Figure 12 LinkIt Smart 7688 in AP Mode.....	25
Figure 13 LinkIt Smart 7688 in Station Mode.....	26
Figure 14 Connecting LinkIt Smart development board to a computer.....	35
Figure 15 Wi-Fi LED Status.....	36
Figure 16 Connecting to LinkIt Smart 7688 AP.....	36
Figure 17 LinkIt Smart 7688 in AP mode.....	37
Figure 18 LinkIt Smart 7688 Web UI Sign In.....	38
Figure 19 Using SSH in Windows PuTTY.....	39
Figure 20 PuTTY Security Warning.....	40
Figure 21 System Console.....	40

Figure 22 LinkIt Smart 7688 COM port using Serial to USB cable .....	42
Figure 23 Using UART to USB cable to access system console in Windows terminal.....	43
Figure 24 Firmware upgrade button .....	45
Figure 25 Selecting firmware file .....	45
Figure 26 Firmware version .....	46
Figure 27 Wi-Fi LED Status During Firmware Upgra .....	46
Figure 28 Factory Reset using LinkIt Smart 7688 Web UI .....	47
Figure 29 Change networking setting in Web UI.....	48
Figure 30 Changing to Station mode in Web UI .....	49
Figure 31 LinkIt Smart 7688 in Station mode connected to a Wi-Fi AP.....	51
Figure 32 System Information in LinkIt Smart 7688 Web .....	52
Figure 33 SCP Security Warning .....	53
Figure 34 WinSCP login window .....	54
Figure 35 File transfer using WinSCP .....	54
Figure 36 File transfer confirmation .....	55
Figure 37 File transfer using Samba in Windows.....	56
Figure 38 Connecting to LinkIt Smart 7688 from Finder .....	57
Figure 39 Connecting to mylinkit.local server in Mac .....	57
Figure 40 Connecting as guest to mylinkit.local on Mac.....	58
Figure 41 MyShareFolder in Mac Finder .....	58
Figure 42 LinkIt Smart 7688 Software Architecture.....	59
Figure 43 Set up the Node.js application prompt.....	65
Figure 44 LinkIt Smart 7688 Duo Hardware Architecture.....	67
Figure 45 LinkIt Smart 7688 Duo package URL for a custom board installation in Arduino IDE .....	68
Figure 46 Arduino IDE Board Manager Menu .....	68
Figure 47 LinkIt Smart 7688 Board Package Menu.....	69
Figure 48 LinkIt Smart 7688 Duo board package installed on Arduino IDE.....	70
Figure 49 LinkIt Smart 7688 Duo installed on Arduino IDE .....	71
Figure 50 Arduino Preference Location.....	72
Figure 51 Driver installation .....	72
Figure 52 Smart 7688 Duo Hardware Architecture .....	73
Figure 53 Software architecture .....	73
Figure 54 Firmata Protocol.....	74
Figure 55 Yun Bridge Library .....	74
Figure 56 Upload Sketch in Arduino IDE .....	76
Figure 57 MPU MCU Communication Diagram .....	78
Figure 58 Copying example code from Github .....	83
Figure 59 Uploading example sketch in Arduino IDE .....	83
Figure 60 Programming bootloader using AVRDUDE .....	89
Figure 61 Finding LinkIt Smart 7688 IP address in Station mode.....	95
Figure 62 Host ID change warning.....	95
Figure 63 Known hosts file.....	96
Figure 64 Finding LinkIt Smart 7688 hardware address .....	97

# 1. Introduction

---

This section provide an overview of the MediaTek LinkIt™ development platforms and introduction to the MediaTek LinkIt Smart 7688 development platform, which also acts as a guide to the content of this document.

## 1.1. What is MediaTek LinkIt?

MediaTek LinkIt™ is a collection of development platforms designed for the prototyping of Wearable and Internet of Things (IoT) devices. Each development platforms provide a collection of tools, hardware and related resources to enable developers to address various Wearable and Internet of Things (IoT) device sectors.

## 1.2. What is MediaTek LinkIt Smart 7688 Development Platform

The MediaTek LinkIt Smart 7688 development platform consists of a Linux Wi-Fi SOC based development board designed to enable the prototyping of IoT devices. These devices include Wi-Fi security web cam and sensors for the home or office, real time camera monitors for toddler and seniors as well as cloud-based applications.

LinkIt Smart 7688 is an open development platform based on the [OpenWrt](#) Linux distribution. The platform provides generous memory and storage to enable rich application development. The platform also offers options to create device applications using Python, Node.js and C.

During prototyping the platform can take advantage of the free [MediaTek Cloud Sandbox](#) service to store data in the cloud. And the [MediaTek Labs Partner Connect program](#) is available to help get devices to market.

## 1.3. Hardware Development Kits

The LinkIt Smart 7688 development platform offers two development boards:

- LinkIt Smart 7688: MPU only. Powered by MediaTek MT7688.
- LinkIt Smart 7688 Duo: MPU and MCU. Powered by MT7688 and ATmega32U4.

For more details on the development boards, please see Chapter 2, “Hardware Development Kit”.

## 1.4. Programming Environment

The LinkIt Smart 7688 development platform supports high-level languages (Python and Node.js) and native application development (C). In addition, the MCU on the LinkIt Smart 7688 Duo can be programmed using the Arduino API and tools.

For more details on the software development options, please see Chapter 3, “Programming Environment Guide”.

## 1.5. Software Development Tool

LinkIt Smart 7688 offers Software Development Tools with utilities for tasks such as configuring the development boards, updating board firmware, managing board support in Arduino and installing software.

For more details on the tools and utilities provided, please see Chapter 4, “Software and Tools”.

## 1.6. Get Started

You can find guide to [getting started](#) with LinkIt Smart 7688 on the MediaTek Lab website and learn how to run a blink example. The step by step guide for the LinkIt Smart 7688 and LinkIt Smart 7688 Duo board covers:

- Setting up development environment.
- Connecting to a LinkIt Smart 7688 development board.
- Upgrading the development board firmware.
- Accessing and using the system console.
- Running the Blink example on a LinkIt Smart 7688 development board.
- Connecting to the Internet.

### 1.6.1. Documentation, code examples and related information

There are several references available to assist with the development of software for LinkIt Smart 7688 prototypes:

- This developer's guide, the latest copy of which is available [here](#) on the MediaTek Labs website.
- [LinkIt Smart 7688 development board pin-out diagram](#): This diagram provides details of the pin breakout on the development board.
- [LinkIt Smart 7688 Duo development board pin-out diagram](#): This diagram provides details of the pin breakout on the development board.

In addition there are a number of resources available to assist with the creation of final device hardware boards:

- [LinkIt Smart 7688 Hardware Reference Design](#): This file includes:
  - LinkIt Smart 7688 development board schematic and layout
  - LinkIt Smart 7688 development board pin-out diagram
  - MediaTek MT7688AN chipset datasheet
- [LinkIt Smart 7688 Duo Hardware Reference Design](#): This file includes:
  - LinkIt Smart 7688 development board schematic and layout
  - LinkIt Smart 7688 development board pin-out diagram
  - MediaTek MT7688AN chipset datasheet

Additional documentation may become available from time to time and can be found on the development platforms [documentation page](#) on the MediaTek Labs website.

## 1.7. More Information

The LinkIt Smart 7688 development platform is based on an open source Linux distribution and supports various high-level programming languages. You can find more information about developing for the software as follows:

- [OpenWrt](#)
- C



- [Python](#)
- [Node.js](#) (JavaScript)
- [Arduino](#)

## 1.8. Join the MediaTek Labs Ecosystem

Wearable and Internet of Things are the next wave in the consumer gadget revolution. MediaTek is a key player in this field, combining the best of two worlds —the existing MediaTek ecosystem of phone manufacturers, electronic device manufacturers, and telecom operators with open, vibrant developer and maker communities.

Whether you're a maker, device manufacturer, student, DIY hobbyist, or programmer, you can use this powerful yet simple platform to create something innovative. You can join the MediaTek LinkIt ecosystem by registering on [labs.mediatek.com](http://labs.mediatek.com), we look forward to you joining our ecosystem and creating something great together.

(The remainder of this page is intentionally left blank)

## 2. Hardware Development Kit

The LinkIt Smart 7688 hardware development kit (HDK) delivers two development boards: LinkIt Smart 7688 (offering an MPU alone) and LinkIt Smart 7688 Duo (offering an MPU and MCU). The MPU is powered by MediaTek's MT7688AN SOC and the MCU is powered by an ATmega32U4.

The MPU supports the OpenWrt Linux distribution; it processes an application's intensive logic tasks and provides Wi-Fi connectivity. It supports Python, Node.js and C programming languages. The MCU handles real-time peripheral control as well as offering the ability to run Arduino sketches.

### 2.1. MediaTek MT7688AN Chip Specification Summary

Specifications of the MT7688AN SOC are shown in Table 1.

MT7688AN SOC Specifications	
CPU	MIPS24KEc (580 MHz)
Total DMIPs	580 x 1.6 DMIPs
I-Cache, D-Cache	64 KB, 32 KB
L2 Cache	N/A
Memory	DDR1/DDR2 16 bits Max. 2 Gb, 193 MHz
SPI Flash	3B addr mode (max 128 Mbit) 4B addr mode (max 512 Mbit)
SD	SD-XC (class 10)
RF	1T1R 802.11n 2.4GHz
Package	DR-QFN156-12 mm x 12 mm
Interface	Count
PCIe	1
USB 2.0	1
Fast Ethernet Switch	5
I2S	1
PCM	1
PWM	4
SPI	1
I2C	1
UARTLite	3
JTAG	1

*Table 1 MT7688AN SOC Specification*

## 2.2. LinkIt Smart 7688

LinkIt Smart 7688 is one of the most highly integrated and compact hardware development boards available for IoT prototyping.

### 2.2.1. Key Features

LinkIt Smart 7688's key features include the following:

- 1T1R Wi-Fi 802.11 b/g/n (2.4G).
- Pin-out for GPIO, I2C, I2S, SPI, UART, PWM and Ethernet Port.
- 580 MHz MIPS CPU.
- 32MB flash and 128MB DDR2 RAM.
- USB host.
- Micro SD slot.

LinkIt Smart 7688 development board is shown in Figure 1.

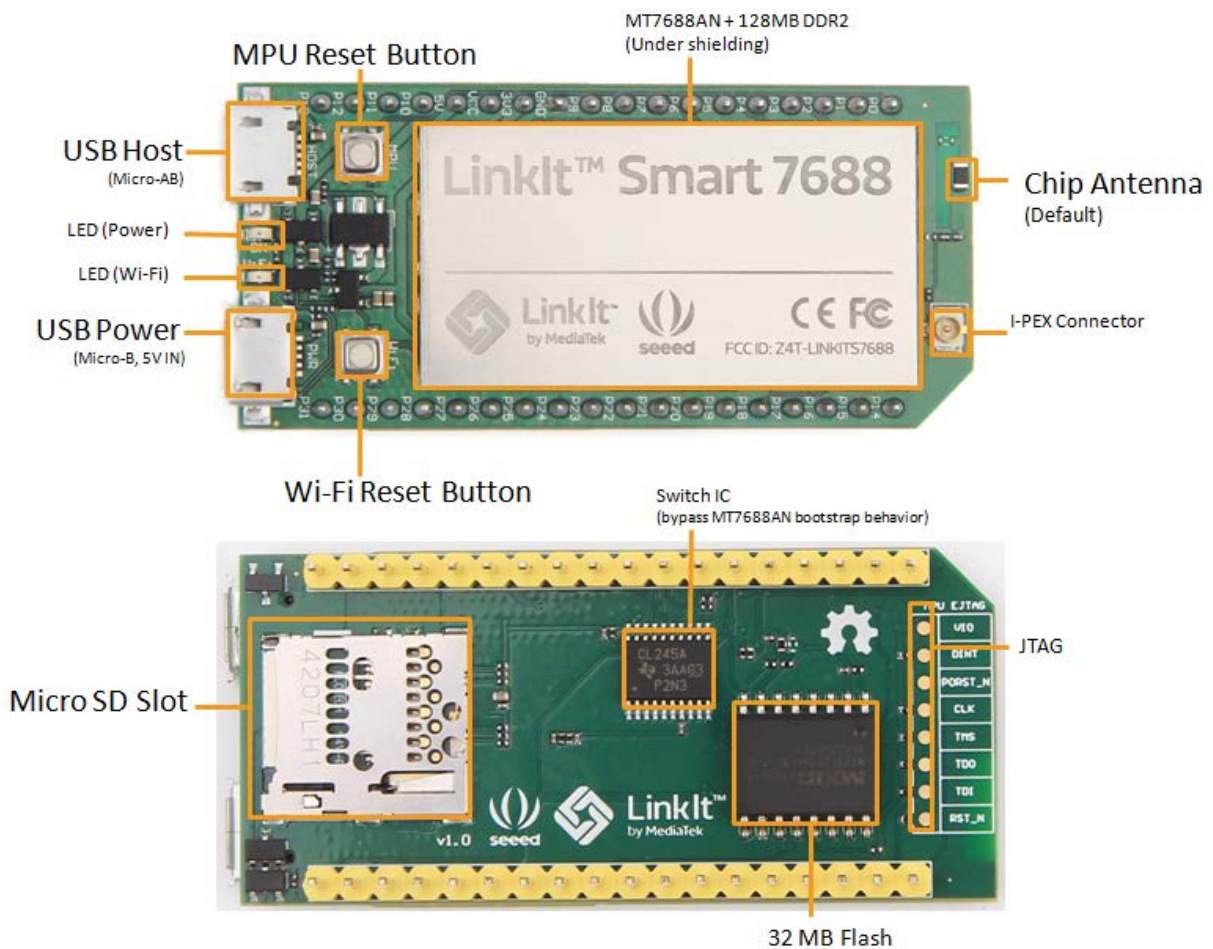

Figure 1 LinkIt Smart 7688 development board (MPU only)

## 2.2.2. Buttons

Description of how to use the buttons on the LinkIt Smart 7688 development board is provided in Table 2.

Scenario	Button	Action
Reset the MPU	MPU Reset Button	One press (with the board booted up)
Reset Wi-Fi to AP mode	Wi-Fi Reset Button	Press for at least 5 seconds and release (with the board booted up)
Factory reset and enter AP mode. <b>WARNING: This will restore the board to default setting and remove all user data</b>	Wi-Fi Reset Button	Press for at least 20 seconds and release (with the board booted up)
Upgrade firmware from a USB drive	Wi-Fi Reset Button	Press the button for at least 5 seconds and release (while the board is powering up)
Upgrade bootloader from a USB drive.	Wi-Fi Reset Button	Press the button for at least 20 seconds and release (while the board is powering up)

*Table 2 LinkIt Smart 7688 Development board buttons*

## 2.2.3. LEDs

This section describes the functions of the LEDs available on the board.

- **Power**  
The Power LED displays solid green when power is supplied to the board.

- Wi-Fi  
The Wi-Fi LED is orange and displays the blink patterns described in Table 3.

Mode	Status	LED blink pattern
AP Mode	With client device	3 blinks per second followed by a pause for 0.5 seconds (cycle repeats)
	Without client device	Off
Station Mode	Disconnected	Off
	Connecting	2 blinks per second
	Connected	Blinks are based on the transmitted data package

**Table 3 Wi-Fi LED blink pattern in LinkIt Smart 7688 HDK**

For more information on Wi-Fi Access Point and Station modes, please see section 3.4, “Network Environment”.

### 2.2.4. Antenna

There are two types of antenna supported on the LinkIt Smart 7688 development board:

- 1) Built in Wi-Fi chip antenna, this is the default antenna.
- 2) I-PEX connector for external antenna.  
To enable the I-PEX connector, you'll need to remove the resistor R233 located on the top left corner of the I-PEX connector, as circled in Figure 2.

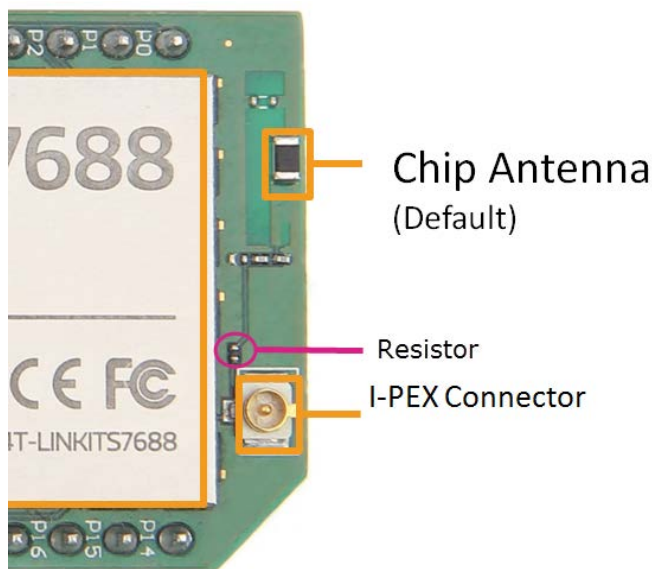

**Figure 2 Removing resistor to enable I-PEX connector**

### 2.2.5. USB Host

LinkIt Smart 7688 provides USB host capability that enables it to connect to various USB devices such as webcams, USB drives, keyboards, joysticks and more. The connector is a USB micro-AB type. Please see Figure 1 for the USB host connector location.

## 2.2.6. USB Power

A USB cable connected to a PC or other power source provides a 5V supply to the LinkIt Smart 7688 development board. When you add peripheral devices such as an SD card, USB drive or other USB device to the development board, additional power may be consumed. Please use a high quality USB cable to reduce power loss. If your peripheral device consumes power heavily, it's better to use an external power source for it.

The approximate power consumption of various scenarios on the LinkIt Smart 7688 are described in Table 4. Please see Figure 1 for the USB power connector location.

Scenario		Approximate Power Consumption
To establish Wi-Fi connection	Peak	475.3 mA
	Average	255.6 mA
Device boot up	Peak	605.4 mA
	Average	195.1 mA
Downloading a file to an SD Card over Wi-Fi	Peak	540.4 mA
	Average	275.8 mA
Downloading a file to a USB Drive over Wi-Fi	Peak	569.5 mA
	Average	304.9 mA
Downloading a file to flash over Wi-Fi	Peak	522.4 mA
	Average	271.3 mA

*Table 4 Typical power consumption scenarios*



Note: The suggested power source is 5V/1A.

## 2.2.7. Accessories

The standard LinkIt Smart 7688 sales package doesn't include accessories; you may therefore require the following:

- 1) **USB Power Cable (Required):** You'll need a USB type A to micro-B plug cable to power the LinkIt Smart 7688 development board from a PC or other USB power source.

- 2) **Micro USB OTG (On-The-Go) or Host Cable (Optional):** An OTG cable, as shown in Figure 3, is used to connect Type A USB devices such as USB drives, USB cameras and more.



*Figure 3 USB OTG cable*

- 3) **USB-UART Cable (Optional):** This cable is used to enable communication to the Linux console.
- 4) **Micro SD Card (Optional):** Use a micro SD card for extra storage space for application code and data.
- 5) **USB Drive (Optional):** For extra storage. You can also use it to store bootloader and firmware to upgrade the LinkIt Smart 7688.



### 2.2.8. JTAG

You can use the JTAG interface to debug MT7688AN. To access the JTAG interface, you'll need to unsolder resistor R95 and solder it to resistor R3 on the development board. After you've moved the resistor and reboot the device you can activate the JTAG function. The hardware configuration steps are:

- 1) Find the group of resistors on the bottom of LinkIt Smart 7688 in the upper-right, as circled in Figure 4.

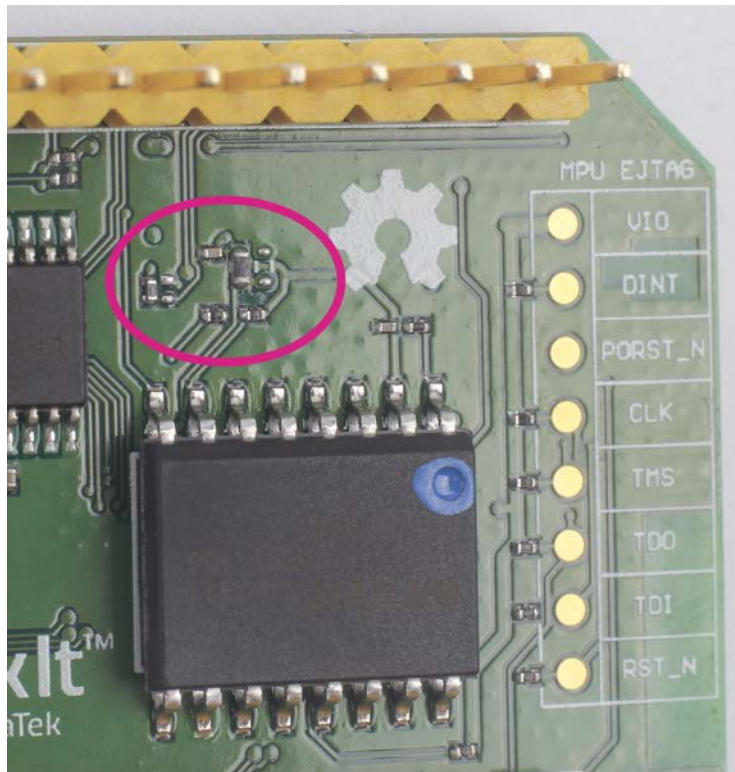

*Figure 4 JTAG resistors on the bottom of the LinkIt Smart 7688*



- 2) Move a resistor by unsoldering and soldering it to a position to the right as shown in Figure 5, after you've finished moving the resistor, restart the device and you should be able to activate the JTAG function.

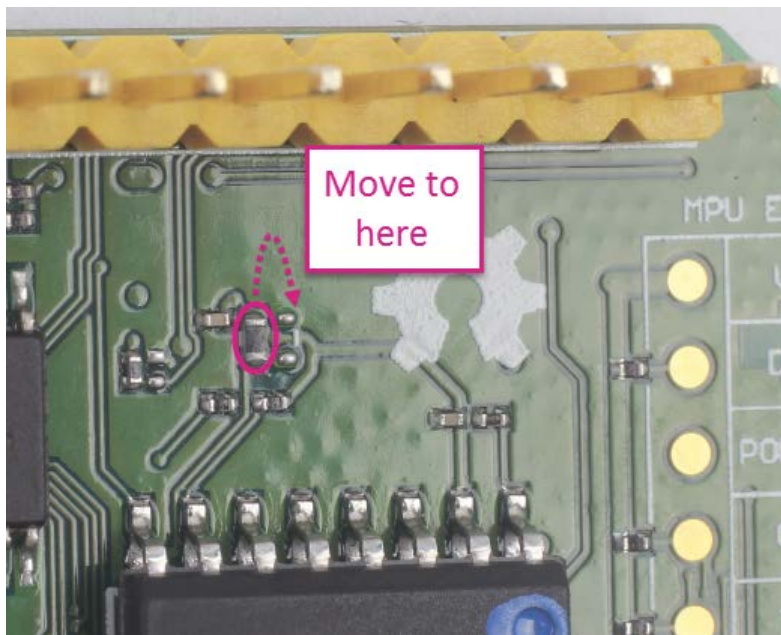

Figure 5 Moving a resistor to access JTAG mode

### 2.2.9. Specifications

The key specifications of the LinkIt Smart 7688 development board are shown in Table 5.

Category	Feature	Specification
MPU	Chipset	MT7688AN
	Core	MIPS24KEc
	Clock speed	580MHz
	Working Voltage	3.3V
PCB Size	Dimensions	55.7 x 26 mm
Memory	Flash	32MB
	RAM	128MB DDR2
Power Source	USB Power	5V (USB micro-B)
	VCC	3.3V (Pin Breakout)
GPIO	Pin Counts	22
	Pin Numbers	P1,P8,P9,P10,P11,P12,P13,P14,P15,P16,P17,P18,P19,P20,P21,P25,P26,P27,P7,P28,P29,P30,P31
	Voltage	3.3v
PWM	Pin Counts	4
	Pin Numbers	P8, P9, P26, P27
	Voltage	3.3v
	Max. Resolution	7 bits (customizable)

Category	Feature	Specification
	Maximum Frequency@Resolution	100kHz@1-bit 50kHz@2-bit 25kHz@3-bit 12.5kHz@4-bit 6.25kHz@5-bit 3.125kHz@6-bit 1.5625kHz@7-bit (Standard mode)
		40MHz@1-bit 20MHz@2-bit 10MHz@3-bit 5MHz@4-bit 2.5MHz@5-bit 1.25Mhz@6-bit 625kHz@7-bit (Fast mode)
External Interrupts	Pin Count	22
	Pin Numbers	P1,P8,P9,P10,P11,P12,P13,P14,P15,P16,P17,P18,P19,P20,P21,P25,P26,P27,P7,P28,P29,P30,P31
SPI	Set count	1
	Pin Numbers	P22, P23,P24 (shared with on-board flash) P25
	Max. Speed	25 MHz
SPI Slave	Set Count	1
	Pin Numbers	P28, P29, P30, P31
	Max. Speed	25 MHz
I2S	Set Count	1
	Pin Numbers	P10, P11, P12, P13
I2C	Set Count	1
	Pin Numbers	P20, P21
	Speed	120K/400K
UART Lite	Set Counts	3
	Pin Numbers	P8, P9, P16, P17, P18, P19
	Max. Speed	115200 bps
USB Host	Set Count	1
	Pin Numbers	P6, P7
	Connector Type	Micro-AB

Category	Feature	Specification
Communication	Wi-Fi	1T1R 802.11 b/g/n (2.4G)
	Ethernet	1-port 10/100 FE PHY
	Pin Numbers	P2, P3, P4, P5
User Storage	SD Card	Micro SD SDXC

*Table 5 LinkIt Smart 7688 development boards specifications*

### 2.2.10. Pin-out Diagram

This pin-out diagram helps you identify and map the pins on LinkIt Smart 7688 development board to the peripheral devices you want to attach through interfaces such as GPIO, PWM, I2C, I2S, SPI, UART and more. The available pins for the LinkIt Smart 7688 are illustrated in Figure 6. For your convenience, this [pin-out diagram](#) can be downloaded from the MediaTek Labs website.

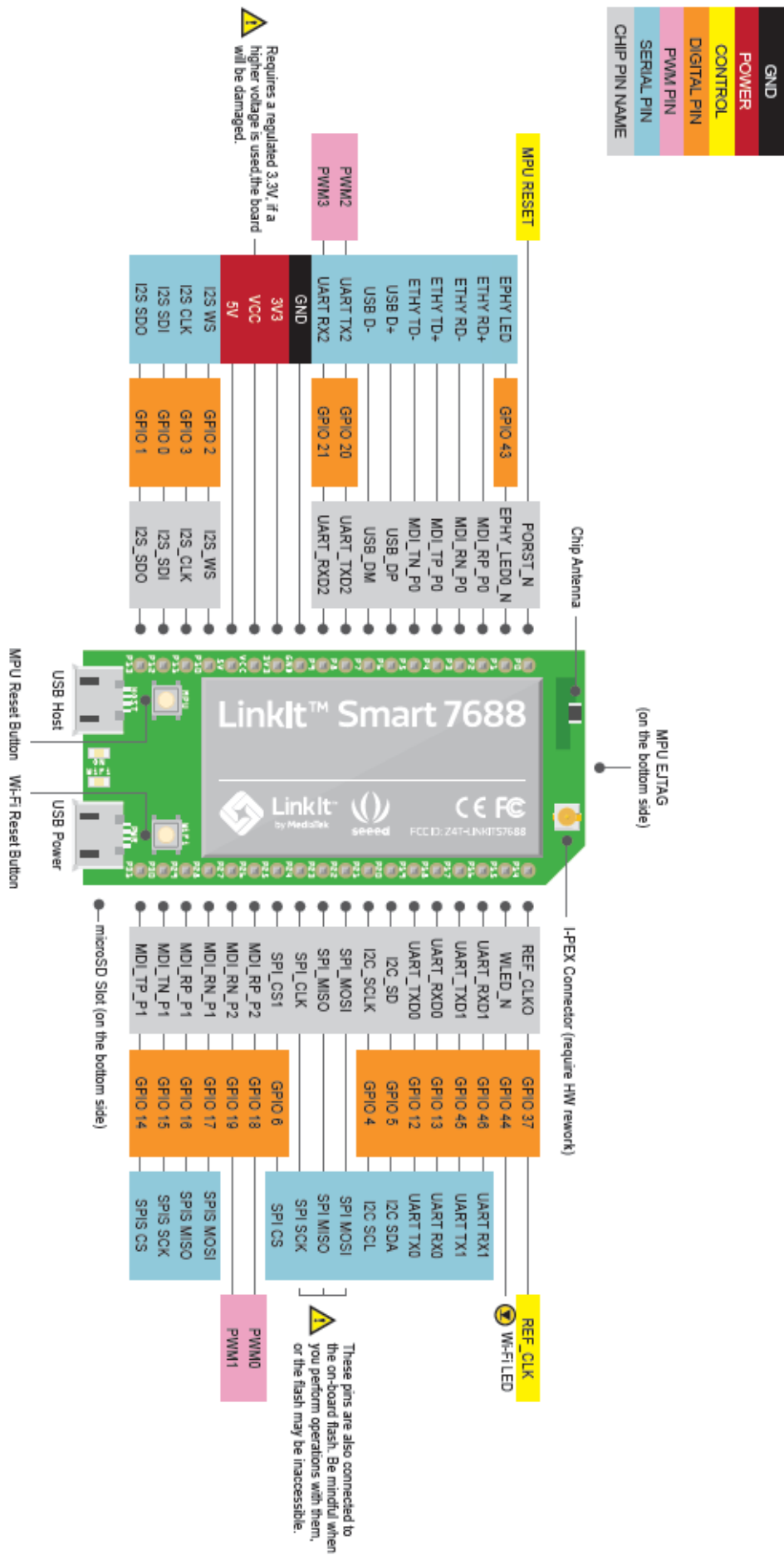

Figure 6 LinkIt Smart 7688 Pin-out Diagram

## 2.3. LinkIt Smart 7688 Duo

The LinkIt Smart 7688 Duo development board is powered by the same MT7688AN SOC as the LinkIt Smart 7688, but includes an ATmega32U4 MCU. This supports additional features including Analog I/O support and Arduino IDE support. The board's functionality is therefore a combination of that provided by the two chipsets: Wi-Fi and Ethernet are supported through OpenWrt Linux on the MT7688AN SOC, and various peripheral supported through Arduino on the ATmega32U4 microcontroller.

### 2.3.1. Key Features

LinkIt Smart 7688 Duo's key features include:

- 1T1R Wi-Fi 802.11 b/g/n (2.4G).
- Pin-out for GPIO, I2C, SPI, UART, PWM, ADC and Ethernet Port.
- 580 MHz MIPS CPU.
- 32MB flash and 128MB DDR2 RAM.
- USB host.
- Micro SD slot.
- Support for Arduino (ATmega32U4)

LinkIt Smart 7688 Duo development board is shown in Figure 7.

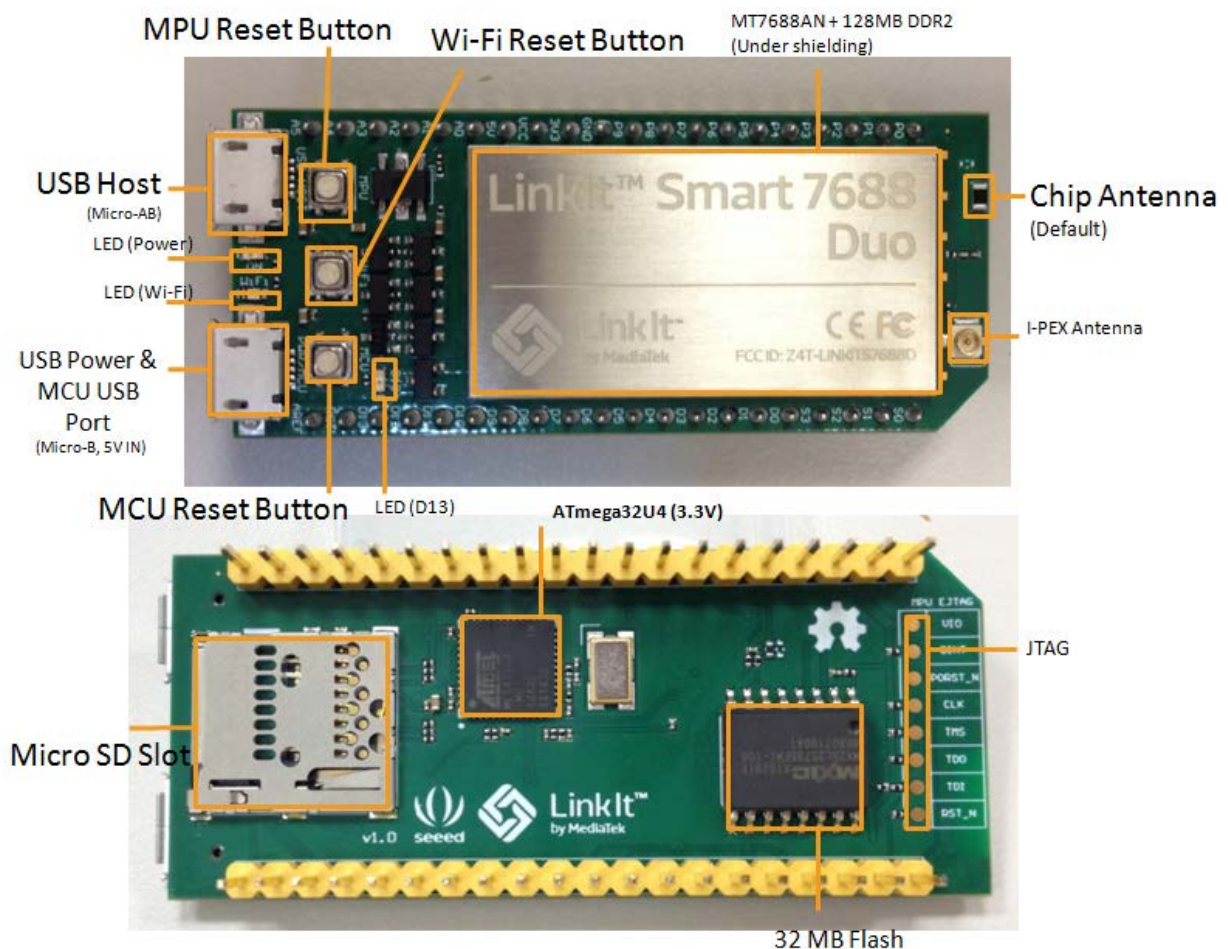

Figure 7 LinkIt Smart 7688 Duo development board (MPU + MCU)

### 2.3.2. Buttons

The buttons description on LinkIt Smart 7688 Duo and how to use them are described in Table 6.

Scenario	Button	Action
Resets the MPU	MPU Reset Button	One press
Resets the MCU	MCU Reset Button	One press
Enters MCU bootloader mode (Timeout after 8 seconds)	MCU Reset Button	Two presses within 750 milliseconds
Resets Wi-Fi to AP mode	Wi-Fi Reset Button	Press the button for at least 5 seconds and release (with the board booted up)
Factory resets and enters AP mode <b>WARNING: Restore to default setting and all user data will be removed from the device</b>	Wi-Fi Reset Button	Press the button for at least 20 seconds and release (with the board booted up)
Upgrades firmware from a USB drive	Wi-Fi Reset Button	Press the button for at least 5 seconds and release (while the board is powering up)
Upgrades bootloader from a USB drive	Wi-Fi Reset Button	Press the button for at least 20 seconds and release (while the board is powering up)

*Table 6 LinkIt Smart 7688 Duo Development board buttons*

### 2.3.3. LEDs

LinkIt Smart 7688 Duo has the same power and Wi-Fi LEDs as the LinkIt Smart 7688 development board. Please see section 2.2.3, “LEDs” for detailed information. In addition to the power and Wi-Fi LEDs, the LinkIt Smart 7688 Duo also has a LED that is tied to pin D13. D13 LED is controlled by the user Arduino program.

### 2.3.4. Antennas

LinkIt Smart 7688 Duo has the same antenna support as LinkIt Smart 7688. Please refer to section 2.2.4, “Antenna” for details.

### 2.3.5. USB Host

LinkIt Smart 7688 Duo provides USB host capability that enables it to connect to various USB devices such as webcams, USB drives, keyboards, joysticks and more. The connector is a USB micro-AB type. Please see Figure 7 for USB host connector location.

### 2.3.6. USB Power

A USB cable connected to a PC or other power source provides a 5V supply to LinkIt Smart 7688 Duo development board. When you add peripheral devices such as an SD card, USB drive or other USB devices to the development board, additional power may be consumed. Please use a high quality USB cable to reduce power loss. If your peripheral device consumes power heavily, it's better to use an external power source for it. Please see Figure 7 for USB Power connector location.

The approximate power consumption of various devices connected to the LinkIt Smart 7688 Duo is described in Table 7.

Scenario		Approximate Power Consumption
To establish Wi-Fi connection	Peak	596.4 mA
	Average	273.5 mA
Device boot up	Peak	672.6 mA
	Average	248.9 mA
Downloading file to a SD Card via Wi-Fi	Peak	605.4 mA
	Average	300.4 mA
Downloading a file to a USB Drive via Wi-Fi	Peak	616.6 mA
	Average	347.5 mA
Downloading a file to flash via Wi-Fi	Peak	578.5 mA
	Average	336.3 mA

*Table 7 Typical power consumption scenarios*

### 2.3.7. Accessories

The standard LinkIt Smart 7688 Duo sales package doesn't include accessories, you may therefore require the accessories which are the same as LinkIt Smart 7688 and they are described in 2.2.7, "Accessories".

### 2.3.8. Breakout Board

A breakout board for LinkIt Smart 7688/ 7688 Duo development boards is available from Seeed Studio. This breakout board provides all the pin-outs from the MT7688AN and ATmega32U4 which allow you to connect sensors and peripherals easily.



### 2.3.9. JTAG

You can use JTAG interface to debug MT7688AN. To access JTAG interface, you will need to unsolder resistor R95 and solder it to resistor R3 on the LinkIt Smart 7688 Duo development board. After you've moved the resistor and reboot the device you'll activate JTAG function. The steps are:

- 1) Find a group of resistors on the bottom side of LinkIt Smart 7688 Duo (top-right view) as circled in Figure 8.

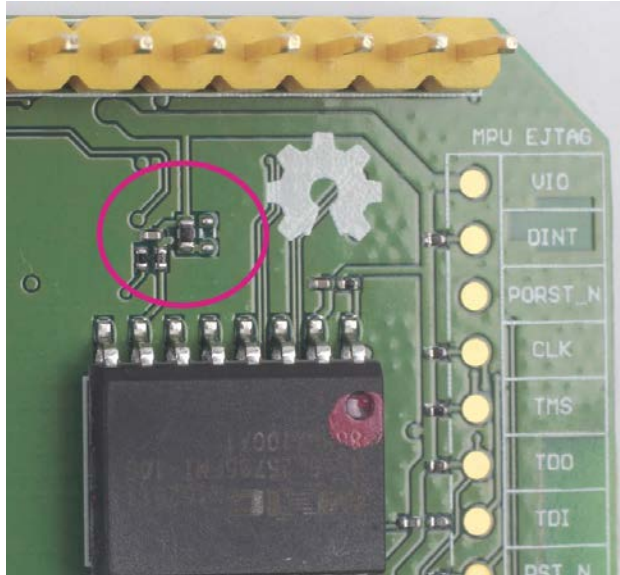

*Figure 8 JTAG resistors on LinkIt Smart 7688 Duo bottom view*

- 2) Next, you will move a resistor by unsoldering and soldering it to a position to the right as shown in Figure 9, after you're finished moving the resistor, restart the device and you should be able to access JTAG mode.

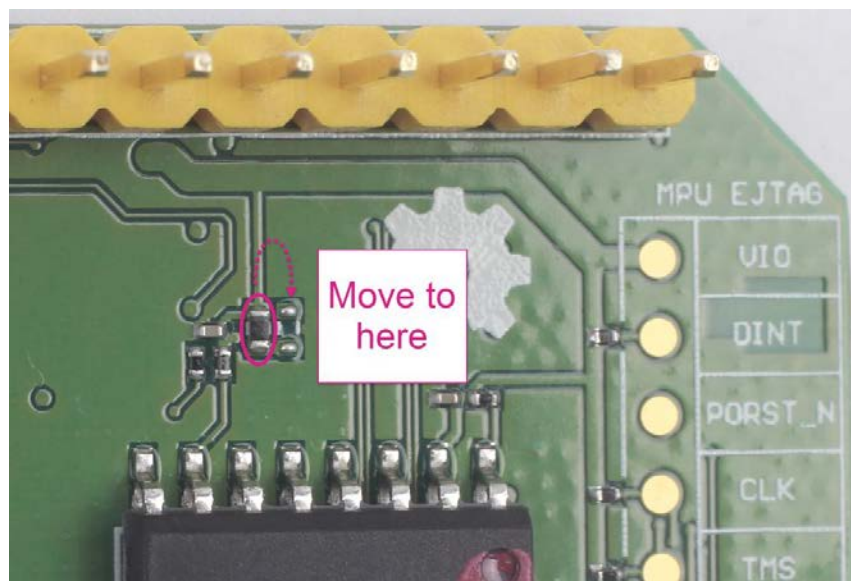

*Figure 9 Moving a resistor to access JTAG mode*



### 2.3.10. Specifications

The key specifications of the LinkIt Smart 7688 Duo development board are shown in Table 8.

Category	Feature	LinkIt Smart 7688 Duo
MPU	Chipset	MT7688AN
	Core	MIPS24KEc
	Clock speed	580MHz
	Working voltage	3.3V
MCU	Chipset	ATmega32U4
	Core	Atmel AVR
	Clock speed	8MHz
	Working voltage	3.3V
PCB Size	Dimensions	60.8 x 26 mm
Memory	Flash	32MB
	RAM	128MB DDR2
Power Source	USB Power	5V (USB micro-B)
	VCC	3.3V (Pin Breakout)
GPIO	Pin Counts	3 (MT7688AN) 24 (ATmega32U4)
	Pin Numbers	P1,P8,P9,A0,A1,A2 ,A3,A4,A5,S0,S1,S2,S3,D0,D1,D2,D3, D4,D5,D6,D7,D8,D9,D10,D11, D12,D13,
	Voltage	3.3v
PWM	Pin Counts	8 (ATmega32U4)
	Pin Numbers	D3, D5, D6, D9, D10, D11, D12, D13
	Voltage	3.3v
	Max. Resolution	16 bits (customizable)
	Maximum Frequency@ Resolution	31.25kHz@8-bit Timer 0 (4 sets) 2MHz@2-bit 122Hz@16-bit Timer 1 & 3 (4 sets) 187.5kHz@8-bit 46.875kHz@10-bit Timer 4 (6 sets)
ADC	Pin Count	12 (ATmega32U4)
	Pin Numbers	A0,A1,A2,A3,A4,A5,D4,D6,D8,D9,D10,D12
	Voltage	3.3v
External Interrupts	Pin Counts	8 (ATmega32U4)
	Pin Numbers	S0,S1,S2,S3,D8,D9,D10,D11

Category	Feature	LinkIt Smart 7688 Duo
SPI	Set Count	1 (ATmega32U4)
	Pin Numbers	S0, S1, S2, S3
	Max. Speed	4 MHz
I2C	Set Count	1
	Pin Numbers	D2, D3
	Speed	400K
UART Lite	Set Count	1 (MT7688AN)
		1 (ATmega32U4)
	Pin Numbers	P8, P9 (MT7688AN)
		D0, D1 (ATmega32U4)
Max. Speed	115200 bps (MT7688AN) 0.5 Mbps (ATmega32U4)	
USB Host	Set Count	1 (MT7688AN)
	Pin Numbers	P6, P7
	Connector Type	Micro-AB
Communication	Wi-Fi	1T1R 802.11 b/g/n (2.4G)
	Ethernet	1-port 10/100 FE PHY
	Pin Numbers	P2, P3, P4, P5
User Storage	SD Card	Micro SD SDXC

**Table 8 LinkIt Smart 7688 Duo development board specifications**

### 2.3.11. Pin-out Diagram

This pin-out diagram helps you identify and map the pins on LinkIt Smart 7688 Duo development board to the peripheral devices you want to attach through interfaces such as GPIO, PWM, I2C, SPI, UART and more. The available pins for LinkIt Smart 7688 Duo are illustrated in Figure 10. For your convenience, this [pin-out diagram](#) is also downloadable from the MediaTek Labs website.

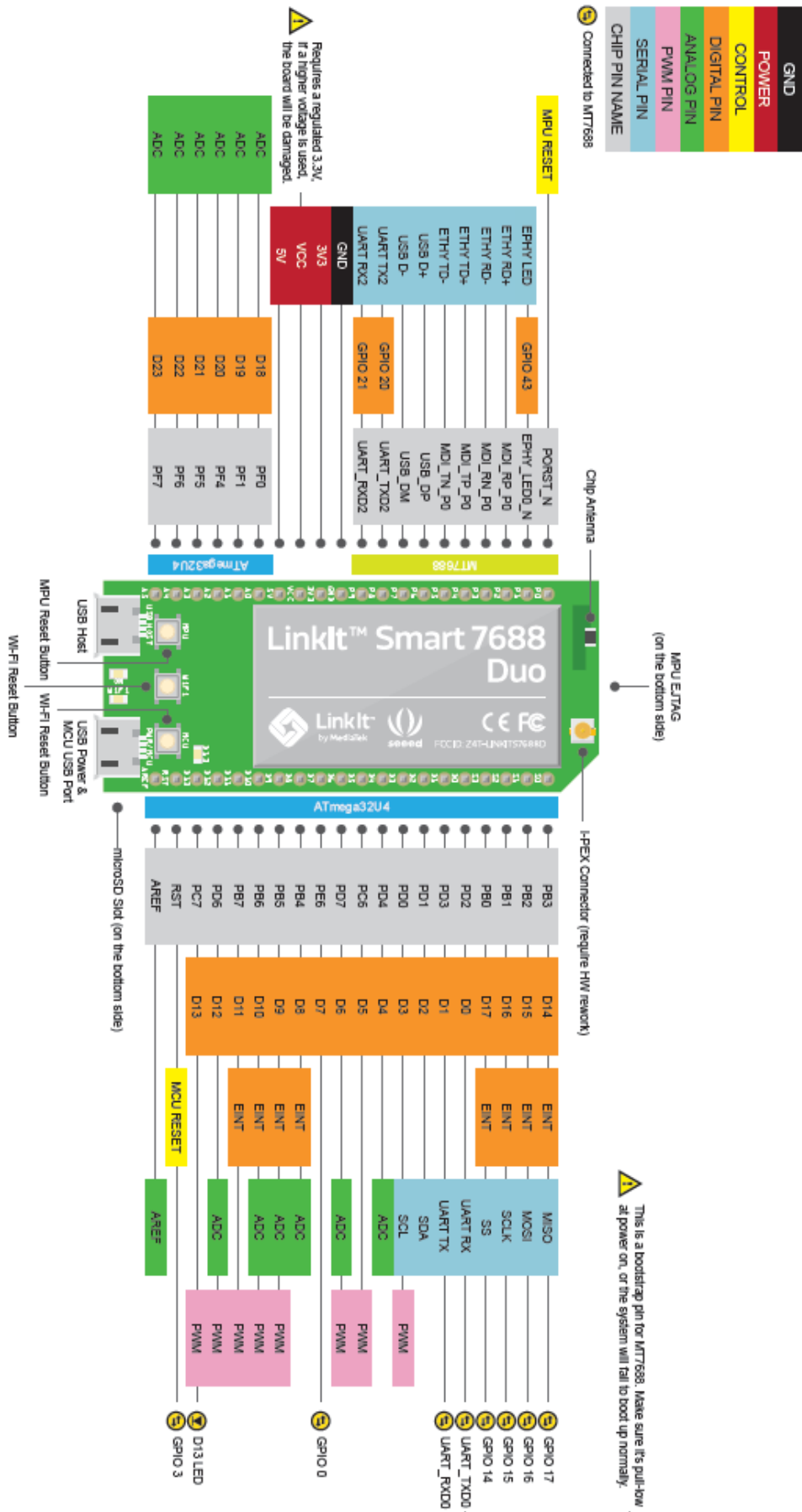

Figure 10 LinkIt Smart 7688 Duo Pin-out Diagram

## **2.4. FCC, CE and NCC Certifications**

LinkIt Smart 7688 and LinkIt Smart 7688 Duo development boards are FCC, CE and NCC certified. For FCC compliance statement, please see Appendix A.

(The remainder of this page is intentionally left blank)

## 3. Programming Environment Guide

---

This chapter introduces the:

- Operating system used on the platform
- Programming environment offered on the LinkIt Smart 7688 development platform
- Different programming models and how they are applied to the development boards
- Network environment available for Wi-Fi communication with the boards
- Methodologies for creating applications in C/C++, Python and Node.js.

### 3.1. Platform operating system

The LinkIt Smart 7688 development platform uses the [OpenWrt](#) open-source embedded Linux operating system, which was originally developed for embedded devices such as wireless routers. Key features of OpenWrt include:

- 1) Comprehensive network control functions,
- 2) Fully writable file system, with package management.
- 3) Rich and extendable feature set, there are over 3,400 packages available and number that continues to grow.

### 3.2. Programming Environment Overview

The LinkIt Smart 7688 development platform runs in OpenWrt Linux environment. It supports development in native C/C++ and the high-level language Python and JavaScript (using Node.js).

With native applications, you can create drivers, frameworks and system applications for devices that require optimal performance. The high-level language development options enable you to build prototypes quickly.

Since LinkIt Smart 7688 doesn't have a display, you need to develop the high level programs remotely in a separate computer, conventionally called the host platform. Majority of the editing and development activities are performed on the host platform, the resulting programs are then transferred to LinkIt Smart 7688 for deployment and execution, the target platform.

The mechanisms you can use during the development cycle are described briefly later in this chapter. Table 9 shows an overview of the LinkIt Smart 7688 programming languages and their related development environment.

Programming language	Tools and libraries	Applications	Host platforms
C/C++	Cross compilation toolchain	System programming	<ul style="list-style-type: none"> <li>OS X</li> <li>Linux</li> </ul>
Python	Python runtime on LinkIt Smart 7688	<ul style="list-style-type: none"> <li>Prototyping</li> <li>Network</li> <li>IoT application</li> </ul>	<ul style="list-style-type: none"> <li>OS X</li> <li>Linux</li> <li>Windows</li> </ul>
Node.js	Node.js runtime on LinkIt Smart 7688	<ul style="list-style-type: none"> <li>Prototyping</li> <li>Network</li> <li>IoT application</li> </ul>	<ul style="list-style-type: none"> <li>OS X</li> <li>Linux</li> <li>Windows</li> </ul>

Table 9 LinkIt Smart 7688 Programming Environment Overview

### 3.3. Programming Model for Different Boards

The LinkIt Smart 7688 and LinkIt Smart 7688 Duo development boards share the same core programming environment. The main difference is the interface available on these two boards, and the additional microcontroller on LinkIt Smart 7688 Duo.

Figure 11 illustrates the different programming models on LinkIt Smart 7688 and LinkIt Smart 7688 Duo and the related software stacks used to access sensors.

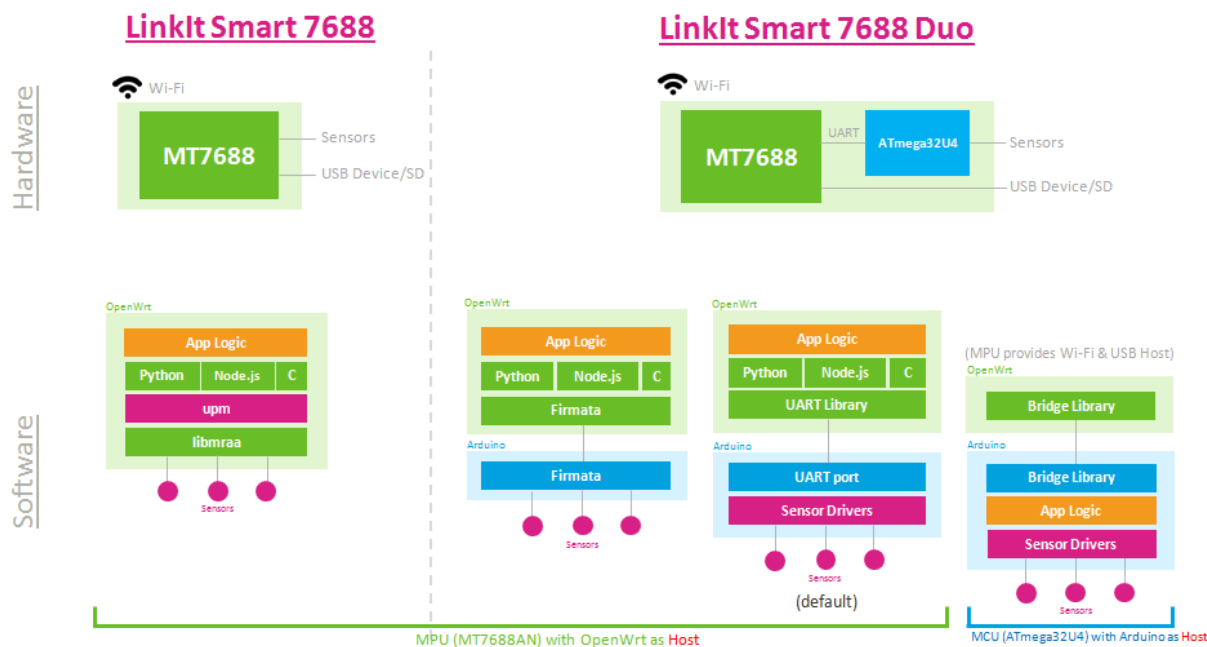

Figure 11 Programming models for the LinkIt Smart 7688 development platform

On the LinkIt Smart 7688 development board external devices and peripherals are connected to the MT7688AN MPU and controlled by the Linux environment. The device application also executes in the Linux environment on the MT7688AN MPU.

While on the LinkIt Smart 7688 Duo development board external devices and peripherals are connected to and controlled by the ATmega32U4 MCU. However, because the MPU and MCU are

able to communicate with one another (over a UART connection), you can choose to create the device application for the MPU (in native C/C++, Python or Node.js) or MCU as Arduino sketches.

Based on different levels of programmability and user scenarios, different software stacks and approaches can be used as shown in Figure 11. If you are using LinkIt Smart 7688 board, refer to chapter 5, “Peripheral Programming on LinkIt Smart 7688” to learn how to connect to different devices and peripherals. If you are using LinkIt Smart 7688 Duo, refer to chapter 6, “Peripheral Programming on LinkIt Smart 7688 Duo” to learn how to setup Arduino IDE for programming on the microcontroller, and how to communicate between MT7688AN and the ATmega32U4 microcontroller.

### 3.4. Network Environment

Wi-Fi communications on the LinkIt Smart 7688 development platform offers two operating modes: Access Point and Station. This section describes those two modes.

#### 3.4.1. Access Point Mode

In AP mode a LinkIt Smart 7688 development board forms a LAN and acts as an access point, as shown in Figure 12. AP mode is used mainly to configure the board settings.

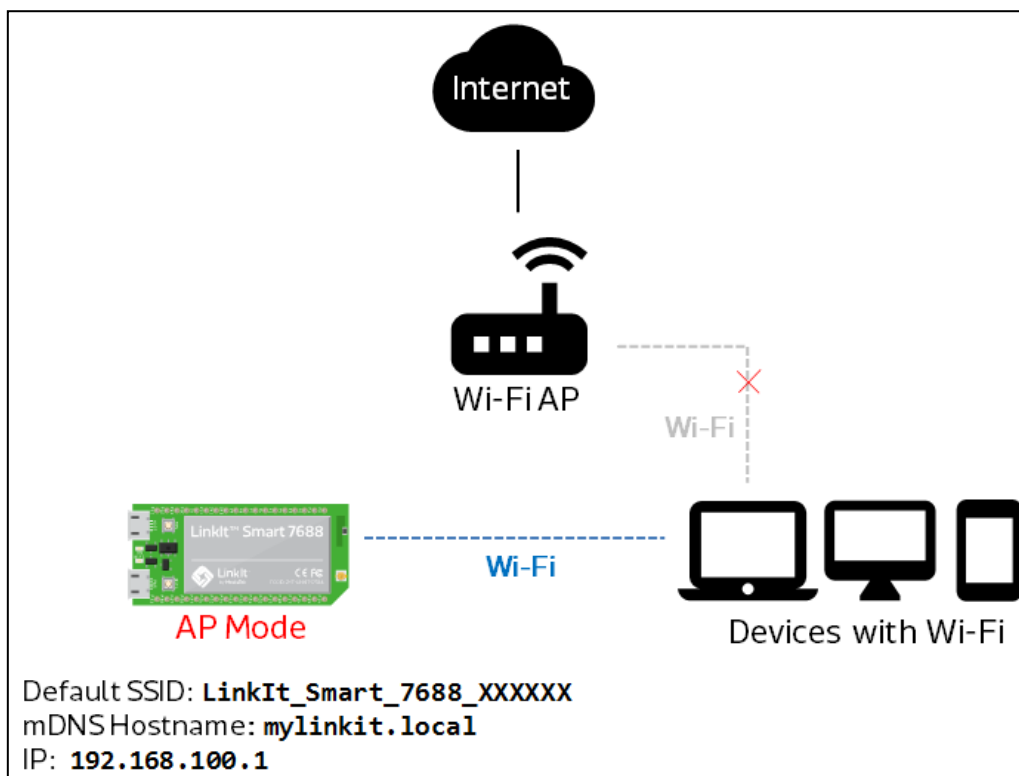

Figure 12 LinkIt Smart 7688 in AP Mode

(The remainder of this page is intentionally left blank)

### 3.4.2. Station Mode

In Station mode a LinkIt Smart 7688 development board is able to access the Internet by joining a Wi-Fi network, as shown in Figure 13.

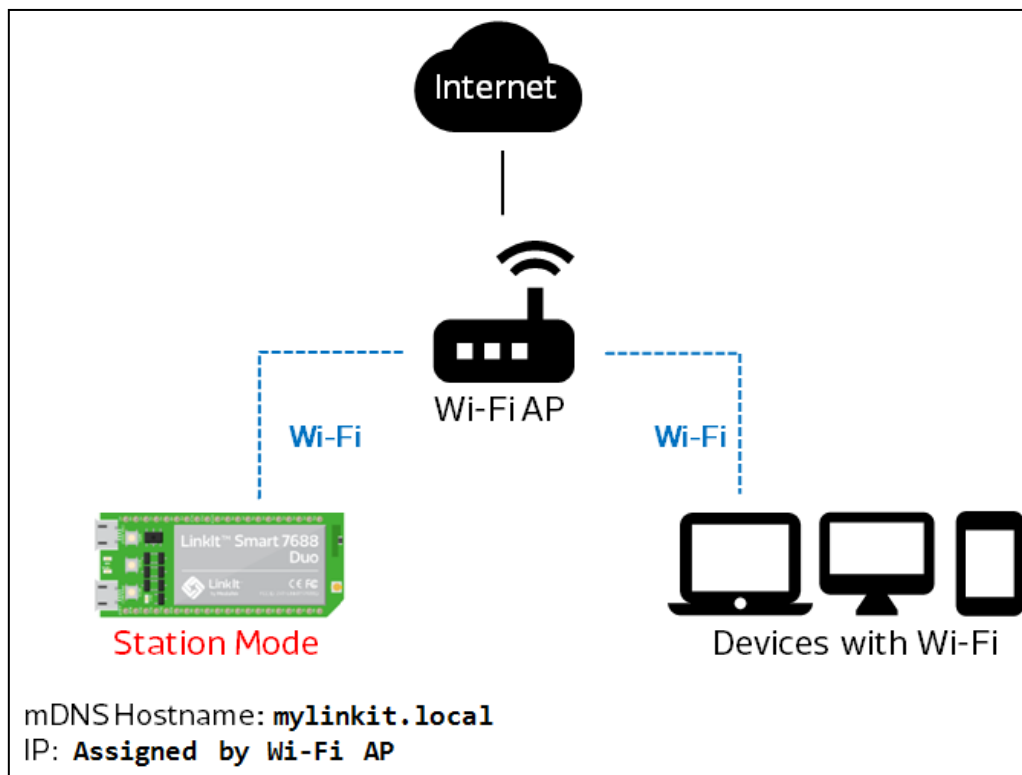

Figure 13 LinkIt Smart 7688 in Station Mode

In addition to being used by the device application to access remote systems or cloud services over the internet, this mode is used to install software from OpenWrt to the board using [opkg package manager](#). In this scenario, your computer joins the same Wi-Fi network as the board and connects to the board through SSH.

## 3.5. Programming in C/C++

Native applications require toolchain programs to compile and link C/C++ source code into executable binaries. While you can install development tools on LinkIt Smart 7688 Linux environment directly, the board's 128MB of RAM may be insufficient for use and this can become a limitation for native application developments.

To avoid running out of memory during native application developments, you should setup the native application development environment in a more powerful *host* environment that enables you to *cross-compile* the application into the executable format of the LinkIt Smart 7688 *target* instead.

### 3.5.1. Setting up C/C++ Programming Environment

The cross compilation toolchain is included in the software package of LinkIt Smart 7688 SDK and supports Mac OS X and Linux. Windows isn't supported at the time of writing.

To use the toolchain, download and unzip it to a directory of your choice and denote the toolchain directory as CC\_TOOLS.



### 3.5.2. Hello World Example in C

- 1) Open a text editor and create a file named `helloworld.c`.
- 2) Copy and paste the example code below and save the file.

```
#include <stdio.h>
int main(int argc, char** argv)
{
    printf("Hello, World!\n");
    return 0;
}
```

- 3) In the host PC, enter the following command to cross-compile the code.

```
CC_TOOLS/bin/mipsel-openwrt-linux-g++ helloworld.c -o helloworld
```

- 4) Assuming the host environment is connected to Wi-Fi of the LinkIt Smart 7688; transfer the output binary named `helloworld` to LinkIt Smart 7688 using **SCP**. For example:

```
scp ./helloworld root@mylinkit.local:helloworld
```

- 5) Finally, execute this program in the SSH terminal of LinkIt Smart 7688:

```
# ./helloworld
```

You should see the string `Hello, World!` as the output.

## 3.6. Programming in Python

High-level programming languages are executed by the corresponding languages interpreter in LinkIt Smart 7688. You can do the programming remotely and send the code to LinkIt Smart 7688 for execution.

### 3.6.1. Setting Up Python Programming Environment

The high-level programming environment is simple. You'll need to install a text editor and a tool to transfer program files between your computer and LinkIt Smart 7688. Please see section 4.7, "File Editor and Transfer".

### 3.6.2. Hello World Example in Python

- 1) Open a text editor, copy and paste the below example code and save it as `helloworld.py`.

```
print "Hello World!"
```

- 2) Assuming the host environment is connected to Wi-Fi of the LinkIt Smart 7688; transfer the output binary named `helloworld` to LinkIt Smart 7688 using **SCP**. For example:

```
scp ./helloworld root@mylinkit.local:helloworld
```

- 3) Execute the example code. You do this in the LinkIt Smart 7688 system console, invoke the Python interpreter by entering the following commands:

```
# python helloworld.py
```

And you should see Hello World! as the program output.

### 3.6.3. Installing additional modules in Python

Python comes with a default package manager utility called **pip**. You can use this utility to install additional Python modules. To use it, first make sure your board is connected to the internet as described in 4.6.5, “Connecting LinkIt Smart 7688 to a Wi-Fi Access Point to Access the internet” or Get Started guide, and check [here](#) for a list of available packages. You can use **pip install** command in the system console to install the packages. For example:

```
# pip install requests
```

This example installs the popular [requests](#) module, which helps you generate HTTP requests easily.

Note that some Python packages that rely on native C/C++ implementation may fallback to Python implementations or fail to install at all because there isn't native compilation toolchain environment available on the board. For example, when installing the `simplejson` module, you'll see a warning during the installation process, as shown below:

```
warning: install_lib: byte-compiling is disabled, skipping.

*****WARNING: The C extension could not be compiled, speedups are not enabled.
Plain-Python installation succeeded.
*****
Successfully installed simplejson
```

The installation still succeeds because `simplejson` provides a pure-python implementation as an alternative – the module still works but may be slower than its native counterparts.

## 3.7. Programming in Node.js

Node.js programming environment in LinkIt Smart 7688 is similar to Python - use a text editor and a file transfer tool to execute the program or use SSH to create your Node.js programs.

Before you start, please make sure you've connected to LinkIt Smart 7688 via SSH. If you need more information please see section 4.5.4.1, “Using SSH (Secure Socket Shell)”.

### 3.7.1. Hello World Example in Node.js

This example executes in the LinkIt Smart 7688 console directly.

- 1) Open a system console via SSH and create a folder named app.

```
# mkdir example
# cd example
```

- 2) Create a file named app.js using vi editor.

```
# vim app.js
```

- 3) In the vi editor, type letter **i** to insert code. Type the codes below.

```
console.log('Hello World');
```

- 4) Save the file and exit the vi editor:
  - a) Press the **Esc** key
  - b) Press **Esc** key and **:wq!**
- 5) Execute the example code by typing the command:

```
# node app.js
```

You should see Hello World as the output string.

### 3.7.2. Installing additional packages in Node.js

Node.js comes with a default package manager utility called npm. You can use this utility to install additional Node.js modules. To use it, first make sure your board is connected to the internet as described in section 4.6.5, “Connecting LinkIt Smart 7688 to a Wi-Fi Access Point to Access the internet” or Get Started guide, and check [here](#) for a list of available packages. You can use **npm install** command in the system console to install the packages. For example:

```
# npm install request
```

This installs the popular [request](#) package, which helps you generate HTTP requests easily.

Note some NPM packages that rely on native C/C++ implementation may fallback to pure JavaScript implementations or fail to install at all because there isn't native compilation toolchain environment available on the board, specifically, the node-gyp. For example, when installing the socket.io package, you'll see a warning message during the installation process, as shown below:

```
sh: node-gyp: not found
npm WARN optional dep failed, continuing utf-8-validate@1.2.1
```

This is because `socket.io` relies on other packages such as `utf-8-validate` and `bufferutil` that require `node-gyp` to build their native implementations. These are optional dependencies to `socket.io` package, so eventually the package installs and you can still use it with some limitation. But for some packages that require native implementations, they may fail to install at all.

## 4. Software and Tools

---

This section describes the software and tools available to create, test, deploy and run applications for the LinkIt Smart 7688 development boards.

### 4.1. Software and Tools

The LinkIt Smart 7688 software and tools include:

- The latest bootloader for the development boards.
- The latest firmware for the development boards.
- The toolchain for libmraa and OpenWrt SDK to enable native application development.

Note that the software and tools don't include editor utilities for Python, Node.js or Arduino developments. For Python and Node.js you use your standard development environment to create your code and then use the system console tools to launch the application on a development board. For Arduino development, the standard Arduino IDE is used to code your sketches and launch them on a board.

### 4.2. Supported Host Environments

Depending on the development model you adopt, you will be able to use a host environment as shown in Table 10.

Development model	Windows	Ubuntu	Mac OS X
Native (OpenWrt) C/C++ applications	No <sup>(1)</sup>	Yes	Yes
Python or Node.js applications	Yes	Yes	Yes
Arduino sketches (LinkIt Smart 7688 Duo only)	Yes	Yes	Yes

**Table 10 OS Capabilities**

(1) You can develop on a Windows computer by using a virtual machine running Ubuntu.

The LinkIt Smart 7688 software and tools support the following OS versions:

- Windows XP, 7, 8 and 10.
- Mac OS X 10.9 and 10.10.
- Ubuntu 14.04 LTS.

### 4.3. Default OpenWrt Packages

Both development boards are pre-loaded with a comprehensive selection of commonly used software packages, as detailed in Table 11.

Package	Description
<a href="#">Dropbear</a>	A light-weight SSH server
<a href="#">cURL</a>	Command line tool for transferring data with URL syntax
stty	Set the options for a terminal device interface
UVC USB camera support	Kernel drivers for USB camera support
Python	Python language support
<a href="#">pySerial</a>	Library for providing serial port access function in Python
Node.js	JavaScript language support
<a href="#">node-serialport</a>	Library for providing serial port access function in JavaScript
Bridge library	Arduino Yun's Bridge library
<a href="#">libmraa</a>	C/C++ library with bindings to JavaScript & Python for I/O interface in Linux
<a href="#">UPM</a>	A set of sensor drivers written in libmraa
OpenSSL	Toolkits for TLS / SSL protocols and cryptography library
AVAHI	Facilitates service discovery on a local network via the mDNS/DNS-SD protocol suite
AVRDUDE	Command line tool for flashing codes to MCU on Linux

**Table 11 Packages included in the LinkIt Smart 7688 development platform**

There are other OpenWrt packages available and you may want to upgrade or install more to expand your tool set. The software can be upgraded and managed using the `opkg` utility. For more information on `opkg`, please see section 4.4, "OPKG Package Manager" or the [OpenWrt website](#).

### 4.4. OPKG Package Manager

OPKG Package Manager is a tool used to install OpenWrt packages from local package repositories or install packages from the internet. You can use this tool to install and update packages on LinkIt Smart 7688.

The main `opkg` arguments used in the command line are as follows:

- **List**

Shows a list of packages currently installed on LinkIt Smart 7688. Example:

```
# opkg list-installed
```

- **Update**

Updates list of available packages. Before installing a new package please ensure to update the list of available package first. Example:

```
# opkg update
```

- **Install**

Installs package(s). The install argument must be followed by the name or fully qualify domain name (FQDN) of the package.

```
# opkg install <pkgs| FQDN>
```

For example to install a text editor called nano, you can either use its package name or its FQDN.

```
# opkg install nano

# opkg install
http://mirror2.openwrt.org/mt7688/packages/nano\_2.4.1-1 ramips
24kec.ipk
```

- **Remove**

This removes a previously installed package(s). For example:

```
# opkg remove <pkgs| globp>
```

- **Upgrade**

This upgrades an installed package to a newer version. For example:

```
# opkg upgrade <pkgs| globp>
```



Note: To perform opkg tasks such as install and upgrade, you'll need to switch the LinkIt Smart 7688 to Station mode; this connects the device to the internet. Please see section 3.4.2, "Station Mode" for more information. Please also be aware if you upgrade a package to a newer version, it may or may not work with your current project due to possible API or behavior changes.

For more information on opkg features, please check the [OpenWrt website](#).

## 4.5. System Configuration

This chapter describes the tools and methods you can use to configure LinkIt Smart 7688 development board.

### 4.5.1. System Configuration Tools

There are two options available for configuring LinkIt Smart 7688 development boards: the Web UI and system console.

The Web UI will enable you to perform most common development related tasks, but to gain full access to the system you'll need to access the system console. A summary of the features of these two options are provided in Table 12.

Configuration	Interface	Connection Method	Reference
Wi-Fi Simple Configuration	Web UI	Wi-Fi network	Connecting to the Web UI
System Configuration	System Console	SSH through Wi-Fi	Using SSH (Secure Socket Shell)
		Kernel Console through UART2 interface	Using Serial to USB Cable

**Table 12 Configuration functions of the Web UI and System console**

In addition, some functions, such as updating the bootloader and firmware can be performed using a USB drive.

#### 4.5.2. Local Domain

The board uses a local domain name **mylinkit.local** and your computer needs to support mDNS to use this local domain. For Windows 8 and later, Mac OS X and Linux, the mDNS is supported. However, if you're using Windows 7, you'll need to install [Bonjour print service](#) to enable your computer to discover LinkIt Smart 7688's IP address within a local domain name.

If you are using a virtual machine, please note that mDNS may have problems reaching the guest OS network. In this case, please use the host OS browser to perform the task in the next section – connecting to the Web UI. You can also use ping utility in the host OS to query the IP address of mylinkit.local and use IP address in the guest OS.



### 4.5.3. Connecting to the Web UI

LinkIt Smart 7688 Web UI allows you to configure system information, upgrade firmware, perform device reset and change between Wi-Fi AP and Station mode and more. The following steps apply to Windows, Mac OS X and Linux.

- 1) Power on LinkIt Smart development board by using any USB power source, for example your computer and a micro USB cable. LinkIt Smart 7688 Duo is used in Figure 14.



**Figure 14** Connecting LinkIt Smart development board to a computer

Make sure you connect the cable to the Power (PWR) connector, not the USB host (HOST) connector near the MPU reset button. The green ON LED (Power on) will light up solid first, followed by a blink from the orange Wi-Fi LED (bootloader initialization). Then, after about 5 seconds, the device boot up starts and the orange LED will light up solid for about 30 seconds.

After boot up, the Wi-Fi LED turns off. This means the system is ready to accept Wi-Fi connection and the steps are described next. The following Figure 15 shows the Wi-Fi LED status and system state:

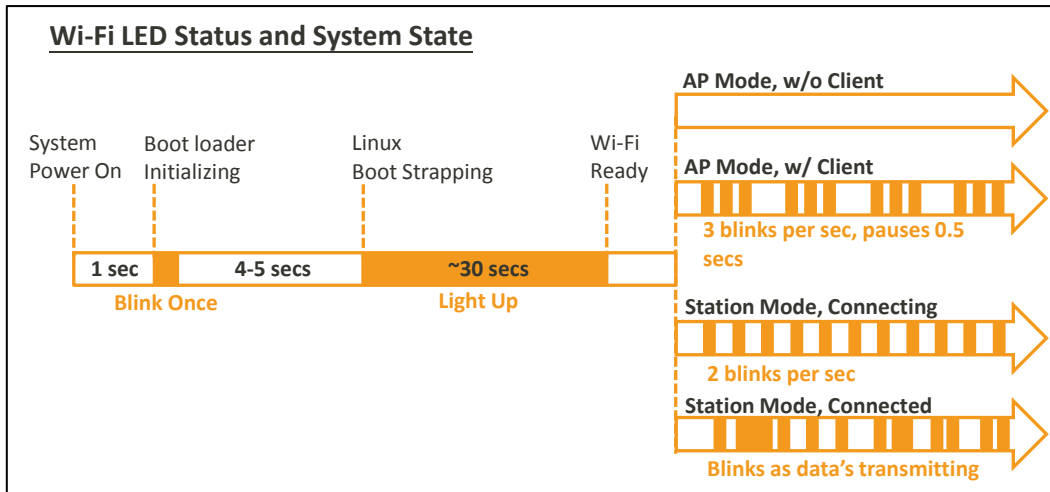

Figure 15 Wi-Fi LED Status

- Open the Wi-Fi connection utility on your computer and connect to the access point named LinkIt\_Smart\_7688\_1B09F3 (1B09F3 is the MAC address and yours could be different), as shown in Figure 16.

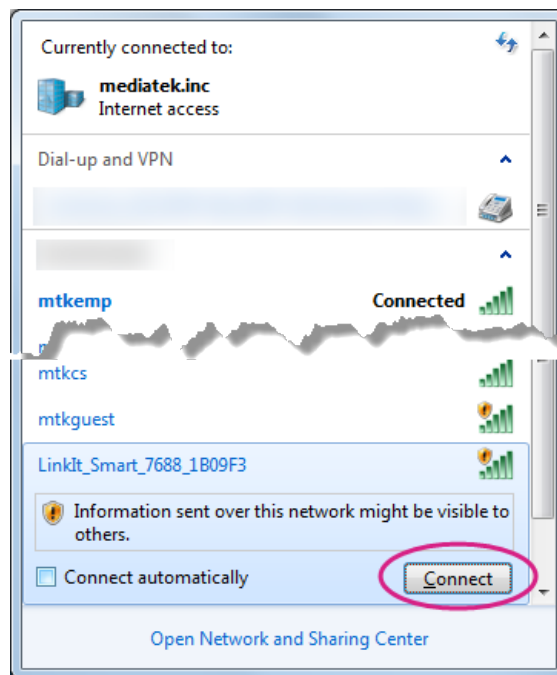

Figure 16 Connecting to LinkIt Smart 7688 AP

After you've connected to LinkIt\_Smart\_7688\_XXXXXX AP, the Wi-Fi LED will blink three times per second.

(The remainder of this page is intentionally left blank)

Keep in mind that once you've connected to LinkIt Smart 7688, your computer may no longer have access to the internet – it is now joined the Local Area Network formed by LinkIt Smart 7688, as shown in Figure 17. You'll learn how to connect LinkIt Smart 7688 to the internet in later steps. But first, you need to configure LinkIt Smart 7688 and the steps are described next.

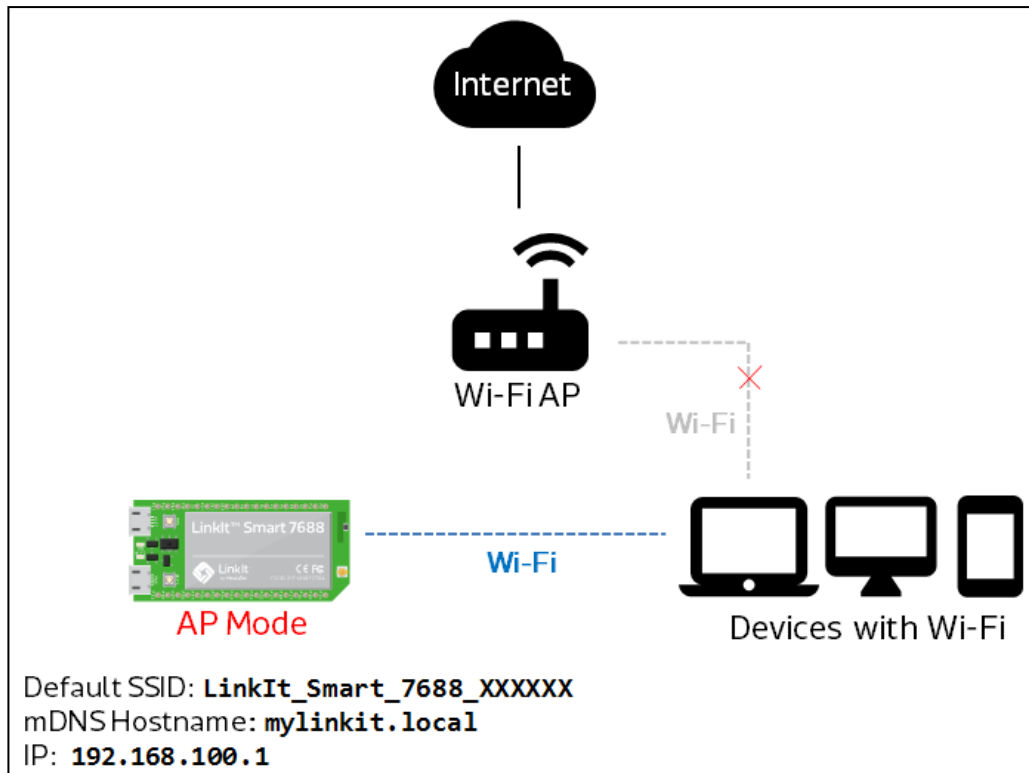

Figure 17 LinkIt Smart 7688 in AP mode

3) In your web browser open `http://mylinkit.local`, as shown in Figure 18.

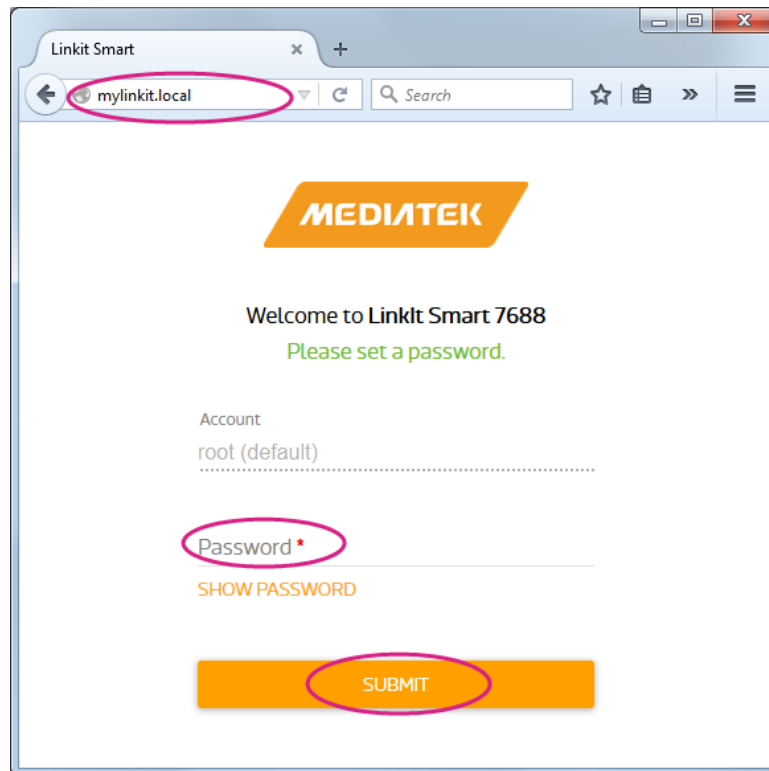

Figure 18 LinkIt Smart 7688 Web UI Sign In



If the board already has a password and you don't have access or lost it, use a USB drive to upgrade firmware or press and hold the Wi-Fi button for at least 20 seconds and release. Keep in mind if you do either of these methods, it will restore to board's default settings and all user data will be removed from the device. For more information on how to upgrade firmware using a USB drive or use the buttons please refer to section 4.6.1, "Upgrading Firmware" or section 4.6.4, "Factory Reset".

4) Click on the **Password** field and set a password using at least 6 alphanumeric characters. Click **Submit** and enter the password again to **Sign In**.

#### 4.5.4. Connecting to the System Console

There are two ways to access the system console on LinkIt Smart 7688 development board. They are described as follows:

##### 4.5.4.1. Using SSH (Secure Socket Shell)

Before you start please make sure you've already set a password in the Web UI as described in section 4.5.3, "Connecting to the Web UI" and the LinkIt Smart 7688 is in the same network as your computer.

- For Windows:
  - 1) Install PuTTY from [here](#).
  - 2) Type **mylinkit.local** in the Host Name box, check the **SSH** radio button and click **Open** as shown in Figure 19.

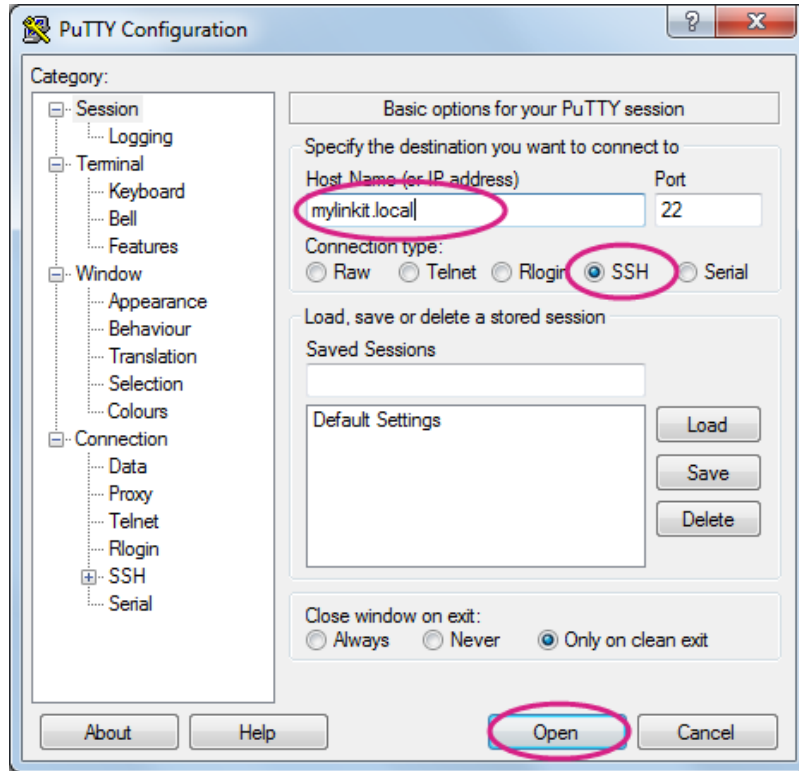

Figure 19 Using SSH in Windows PuTTY

- 3) A Security Alert window will pop up as shown in Figure 20 below, this happens when you use PuTTY for the first time, or after upgrading firmware, or use a different board. Click **Yes**.

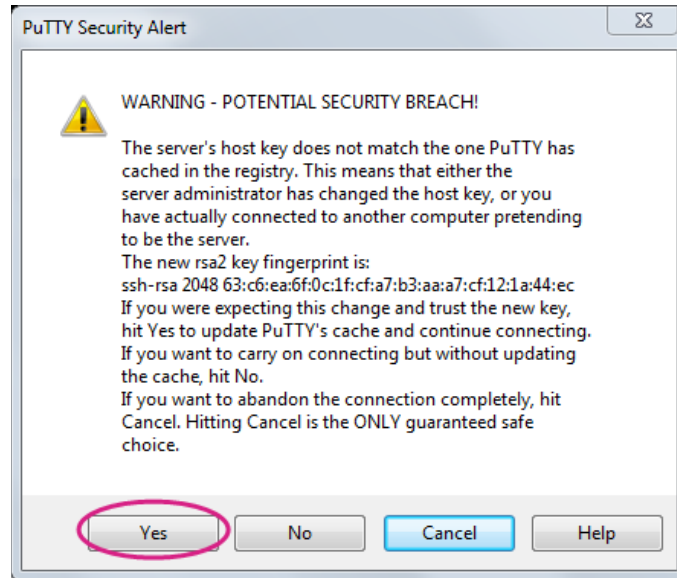

Figure 20 PuTTY Security Warning

- 4) In the PuTTY terminal window that opens, log in with username **root** and enter the password you set previously in the Web UI, after log in you should see a screen similar to Figure 21.

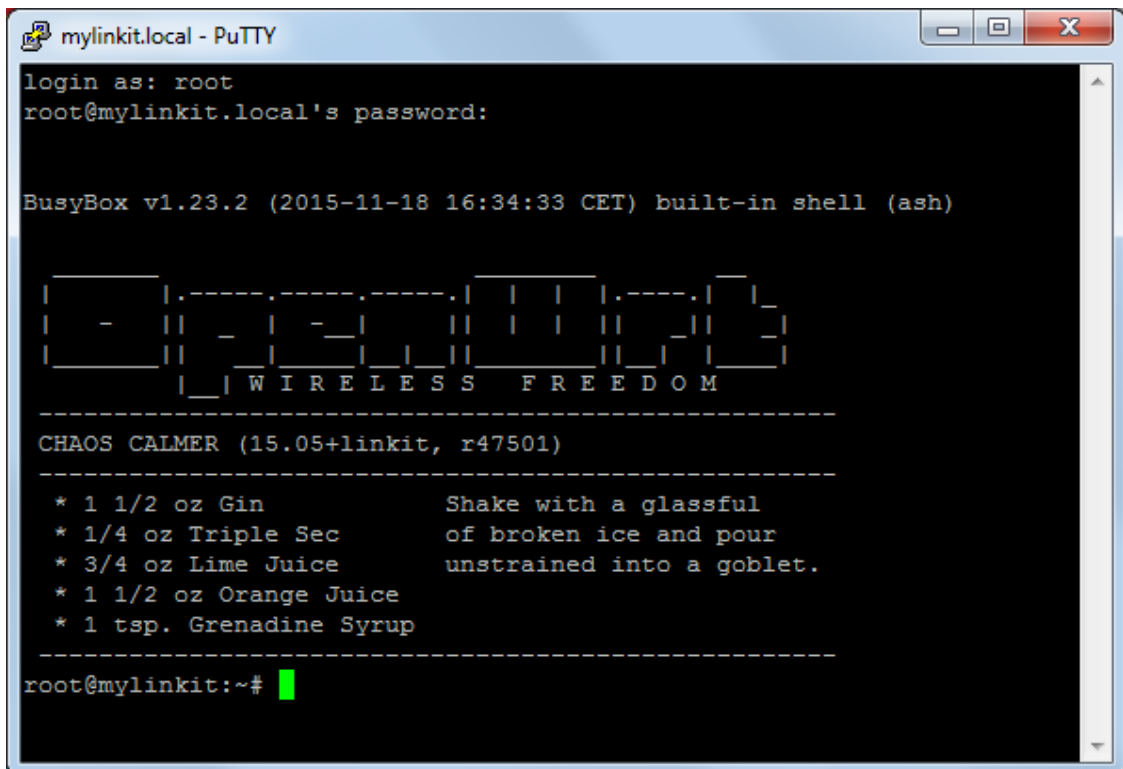

Figure 21 System Console

- **For Mac:**

Open Terminal. In the Terminal, type **ssh root@mylinkit.local** at the command line, hit return and you'll be prompted to enter the root password. Enter the password you set previously in the Web UI.

- **For Linux:**

Open Terminal. In the Terminal, type **ssh root@mylinkit.local** at the command line, hit return and log in using the password you set previously.

If you see an error indicating problems with host ID, please refer to FAQ on MediaTek Labs website

For more information on using SSH, please reference [here](#).

#### 4.5.4.2. Using Serial to USB Cable

You can connect to the system console of LinkIt Smart 7688 by using a Serial (or UART) to USB cable. First, you need to check if your cable requires driver installation; it may or may not be needed. Please check the following sections per your OS.



Note: Download the executable version corresponding to your OS from the **Currently Supported VCP Drivers** list (FTDI chips only). After installation, the COM port will be successfully identified.

- **For Windows:**

- 1) Install driver. If you're using a USB cable based on FTDI chip please download and install its driver from [here](#). If you're having problems with the latest driver, try installing an [older version](#).
- 2) Next, you'll need to connect the Serial to USB cable to LinkIt Smart 7688's UART pins in the following table as shown in Table 13:

UART to USB Cable	LinkIt Smart 7688 UART pins
RX	P8
TX	P9
GND	GND

*Table 13 USB and LinkIt Smart 7688 UART Pin Mapping*

- 3) After you've connected the Serial to USB cable, open the device manager and notice the COM port number as shown in Figure 22. This number may vary on different computers.

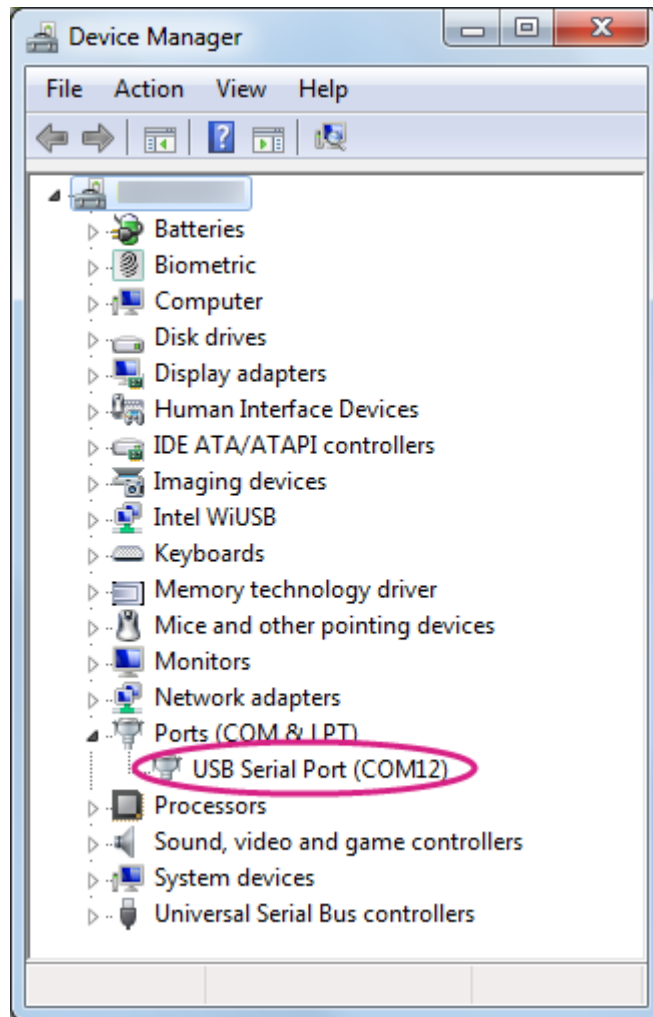

*Figure 22 LinkIt Smart 7688 COM port using Serial to USB cable*



- 4) Open the PuTTY terminal and enter the **COM port** number of the USB device found in the device manager, click on the **Serial** radio button, type **57600** in Speed box and click **Open**, as shown in Figure 23.

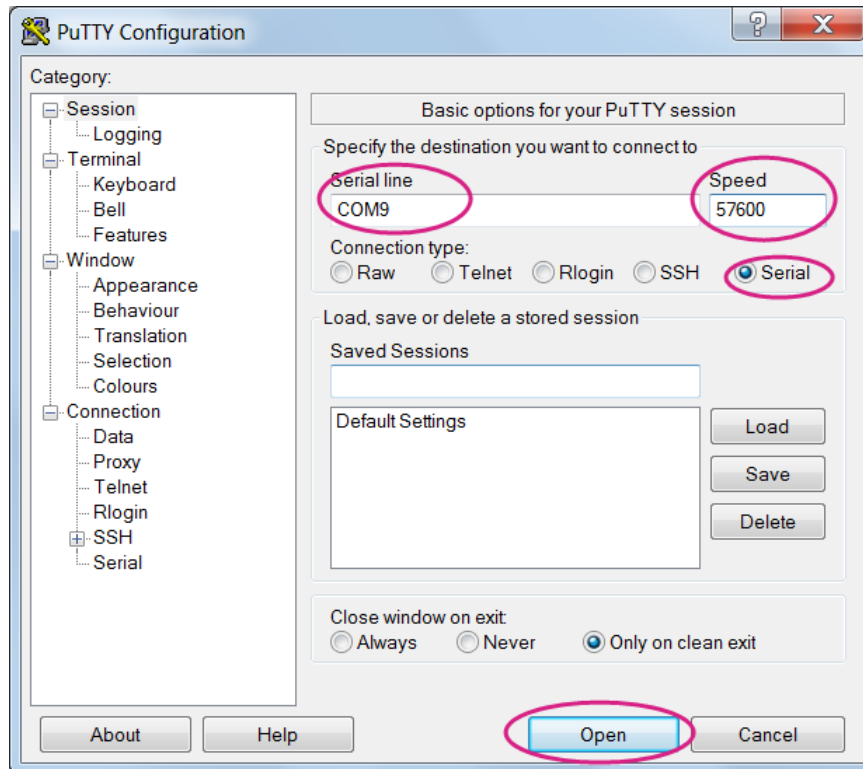

*Figure 23 Using UART to USB cable to access system console in Windows terminal*

- 5) To exit the system console, click the **X** on top right of the PuTTY windows.
  - **For Mac:**
    - 1) Install the driver if needed. Check the cable manufacturer’s website for driver requirements on Mac and installation instructions.
    - 2) Plug-in the cable and connect the cable to LinkIt Smart 7688.
    - 3) Open a Terminal session. You can open it at Applications/Utilities/Terminal.
    - 4) Type **ls /dev/cu\*** in the Terminal. You should see a list of devices. Look for something like **cu.usbserial-XXXXXXX** where **XXXXXXX** is usually a random identifier. This is the serial device used to access the system console. For example:

```
$ls /dev/cu*
/dev/cu.Bluetooth-Incoming-Port
/dev/cu.Bluetooth-Modem
/dev/cu.pablop-WirelessiAP
/dev/cu.usbserial-A6YMCQBR
```

- 5) Use the screen utility to connect to the serial port and set the baudrate to **57600**. This is because the baudrate of the system console is **57600** by default. For example:

```
$screen /dev/cu.usbserial-XXXXXXX 57600
```

- 6) Now you should be connected to the system console. Press **ENTER** in the Terminal to bring up the prompt. You'll notice that the prompt has become different from your OS X Terminal application, it is the LinkIt Smart 7688 prompt and it looks like the following:

```
root@myLinkIt:/#
```

- 7) You're ready to make changes to the LinkIt Smart 7688 system through this console.

- 8) To exit the system console, type **<CTRL>a + k**, and **y**.

- **For Linux:**

- 1) Install the driver if needed. Check the cable manufacturer's website for driver requirements on Ubuntu and installation instructions.
- 2) Plug-in the cable and connect the cable to LinkIt Smart 7688.
- 3) Open a Terminal application.
- 4) Type **ls /dev/ttyUSB\*** in the Terminal. You should see a list of devices. Look for something like **ttyUSB0** where **0** is usually a random identifier. This is the serial device used to access the system console. For example:

```
$ls /dev/ttyUSB*
/dev/ttyUSB0
```

- 5) Use the screen utility to connect to the serial port and set the baudrate to **57600**. This is because the baudrate of the system console is **57600** by default. One thing to keep in mind is that in Ubuntu, the serial devices require **dialout** group permission. Use **sudo** to elevate the permission, for example:

```
$sudo screen /dev/ttyUSB0 57600
```

- 6) Now you should be connected to the system console. Press **ENTER** in the Terminal to bring up the prompt. You'll notice that the prompt has become different from your Linux Terminal application, it is the LinkIt Smart 7688 prompt and it looks like the following:

```
root@myLinkIt:/#
```

- 7) You're ready to make changes to the LinkIt Smart 7688 system through this console.

- 8) To exit the system console, type **<CTRL>a + k**, and **y**.

## 4.6. System Configuration tasks

This section describes the system configuration task you will need to perform and how to perform them in the Web UI or system console, or using a USB memory stick.

### 4.6.1. Upgrading Firmware

This section describes how to upgrade the firmware. You can choose from one of the following two ways to upgrade firmware on LinkIt Smart 7688:



Note: All user data will be removed from the device after firmware upgrade. The firmware is the same for both LinkIt Smart 7688 and Duo boards.

- **Using Web UI:**

- 1) Sign in the LinkIt Smart 7688 Web UI. Please see section 4.5.3, “Connecting to the Web UI” if you haven’t signed in before.
- 2) After you’ve signed in, click on the **UPGRADE FIRMWARE** as shown in Figure 24.

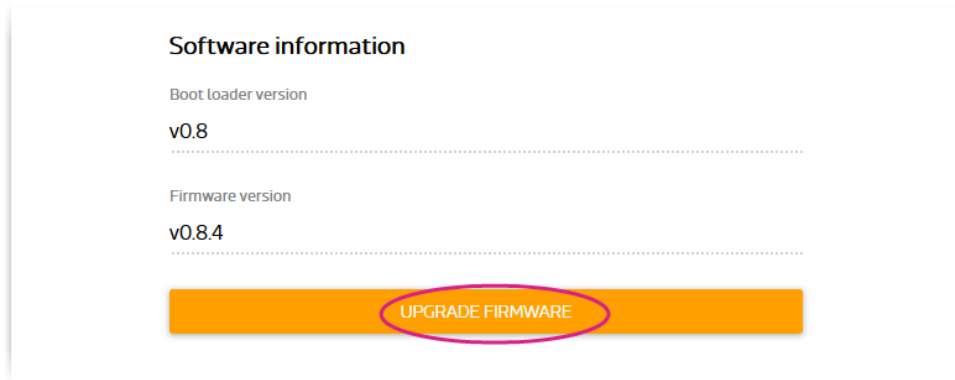

*Figure 24 Firmware upgrade button*

- 3) Click **Choose the file** and select 1ks7688 .img file. Click **UPGRADE & RESTART** as shown in Figure 25.

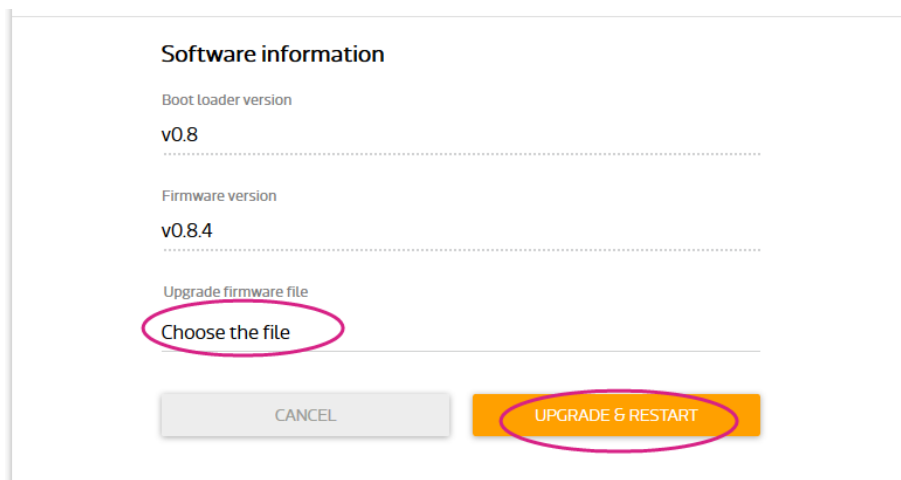

*Figure 25 Selecting firmware file*

- 4) The firmware will upload to LinkIt Smart 7688, please make sure the device stays connected to its power source until the firmware upgrade is completed.
- 5) The orange LED will blink for approximately 3 minutes, watch the Wi-Fi LED, it will light solid to indicate the firmware upgrade has completed and the device will reboot.

- After a few seconds, the Wi-Fi LED turns off. Use the Wi-Fi utility and scan for the LinkIt\_Smart\_7688\_XXXXXX AP and connect to it. Reload the mylinkit.local webpage. Set a new password and sign in to see the new firmware version in the software information as shown in Figure 26.

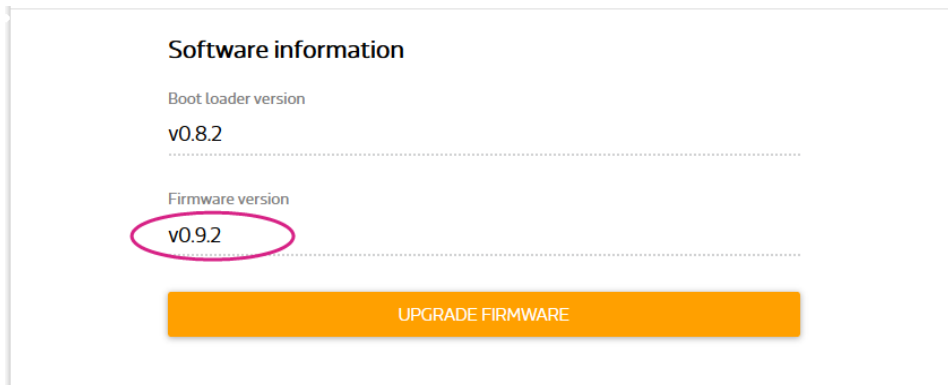

Figure 26 Firmware version

You now have the latest firmware on your LinkIt Smart 7688 development board.

- Using a USB drive :**

The USB drive must be in FAT file system or the file cannot be recognized by the LinkIt Smart 7688 development platform.

- Save the firmware file (lks7688.img) in the root directory of a USB drive. You can download the latest firmware from MediaTek Labs website.
- Plug the USB drive to LinkIt Smart 7688.
- Press the Wi-Fi and MPU (Reset) button, then release the MPU Reset button only but hold the Wi-Fi button for at least 5 seconds and release (Wi-Fi LED turns off), see Figure 27 for detailed LED status. Do not press the Wi-Fi button for longer than 20s or it will upgrade the bootloader.

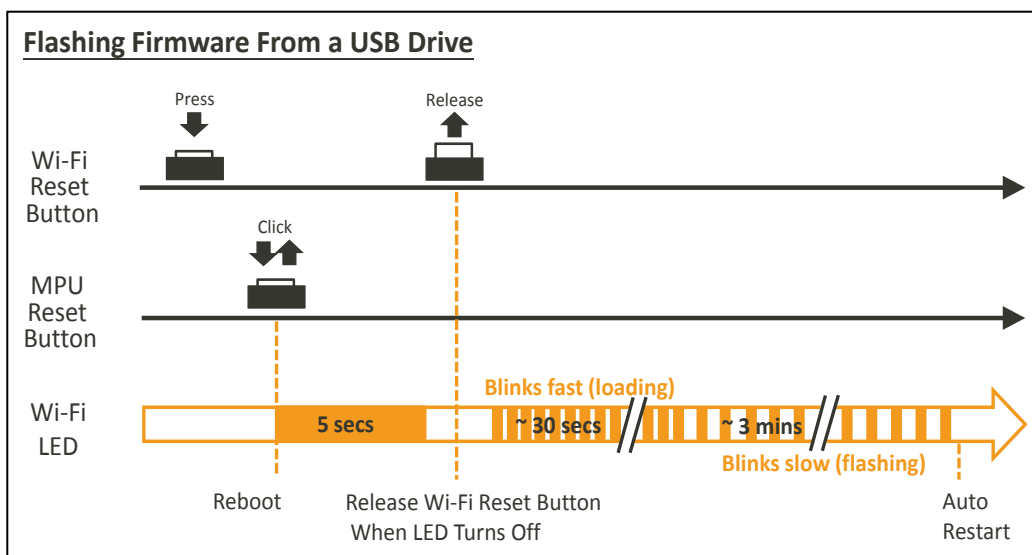

Figure 27 Wi-Fi LED Status During Firmware Upgra

- LinkIt Smart 7688 will start to read the firmware image (Wi-Fi LED blinks fast) and perform the firmware upgrade process (Wi-Fi LED blinks slowly). This process takes about 3 minutes to finish.

### 4.6.2. Upgrading bootloader



**Warning:** Do not disconnect the power source or unplug the USB drive during bootloader upgrading process, or else the data in flash will be damaged and the device will be damaged and fail to boot up again.

This section describes how to upgrade the bootloader. The USB drive must be in FAT file system or the file cannot be recognized by the LinkIt Smart 7688 development platform.

Please follow these steps:

- 1) Save the bootloader file (1ks7688.ldr) in the root directory of a USB drive and name it 1ks7688.ldr, you can download the latest bootloader from MediaTek Labs website.
- 2) Plug the USB drive to LinkIt Smart 7688.
- 3) Press the Wi-Fi and MPU (Reset) button at the same time, then release the MPU Reset button but hold the Wi-Fi button for at least 20 seconds (after 20s Wi-Fi LED will turn on) and release.
- 4) LinkIt Smart 7688 development board will start to read the bootloader (Wi-Fi LED blinks fast) and perform the bootloader upgrade process (Wi-Fi LED blinks slowly). It takes about 2 seconds to finish the bootloader upgrade process.

### 4.6.3. Wi-Fi Reset

Press the Wi-Fi Reset button for at least 5 seconds and release. The device will go into AP mode.

### 4.6.4. Factory Reset

This section describes how to do factory reset on LinkIt Smart 7688 development board. Factory reset will erase all user data from the board, so proceed with caution. Choose from one of the following two ways to perform factory reset.

- **Using Web UI**

Sign in the Web UI, if you need more information refer to section 4.5.3, “Connecting to the Web UI”, under Factory reset, click **RESET**, as shown in Figure 28.

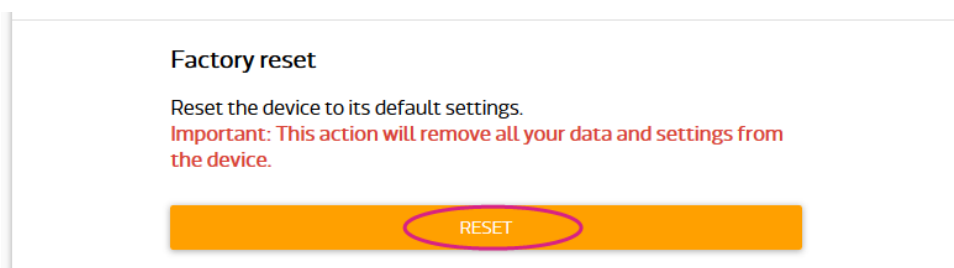

*Figure 28 Factory Reset using LinkIt Smart 7688 Web UI*

- **Using the Wi-Fi Reset button**

After LinkIt Smart 7688 boots up, press the **Wi-Fi Reset button** for at least 20 seconds and release. Please see Figure 1 and Figure 7 for Wi-Fi Reset button locations. LinkIt Smart 7688 development board will reboot to default settings and all user data will be eliminated from the board, so proceed with caution.

### 4.6.5. Connecting LinkIt Smart 7688 to a Wi-Fi Access Point to Access the internet

This section describes how LinkIt Smart 7688 development board connects to an AP in a Wi-Fi network to access the internet. To connect to an access point, LinkIt Smart 7688 needs to be in Station mode. For more information please see section 3.4, "Network Environment".

#### 4.6.5.1. Using the Web UI

Open a browser with URL `mylinkit.local`. Please see section 4.5.3, "Connecting to the Web UI" if you've not signed in before.

- 1) Click **Network** button on upper right as shown in Figure 29.

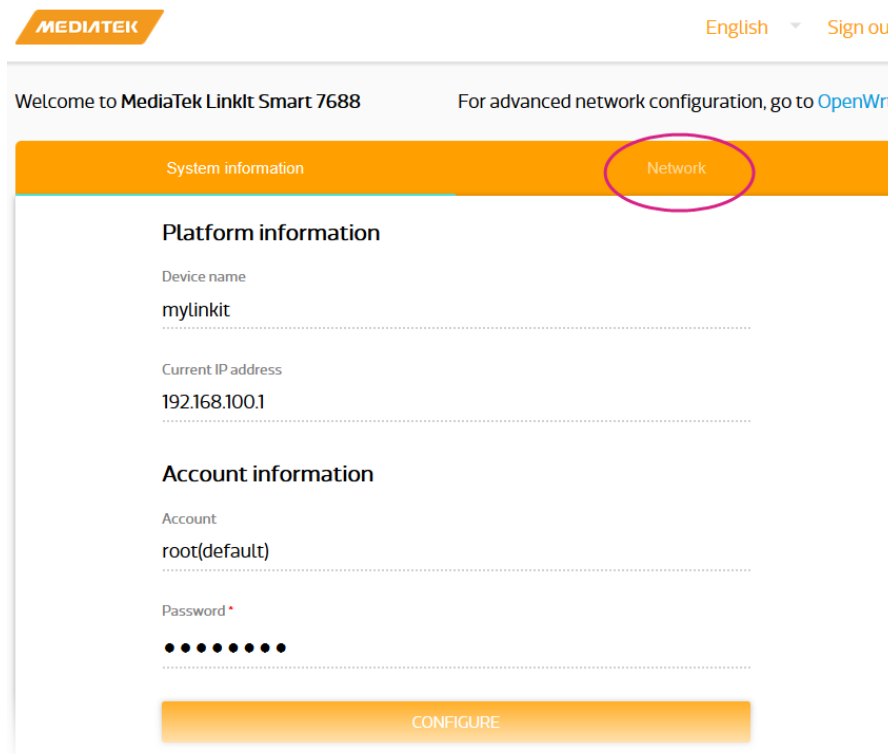

**Figure 29** Change networking setting in Web UI

- 2) Select the **Station mode** and click **REFRESH** or **downward arrow** on the right to find the AP to connect to. After you've selected the AP, enter password if required. Click **CONFIGURE & RESTART** to finish as shown in Figure 30.



Note: If you entered the AP's password incorrectly, you can reset the board to AP mode by clicking the Wi-Fi button for at least 5 seconds and restart network setting to Station mode again.

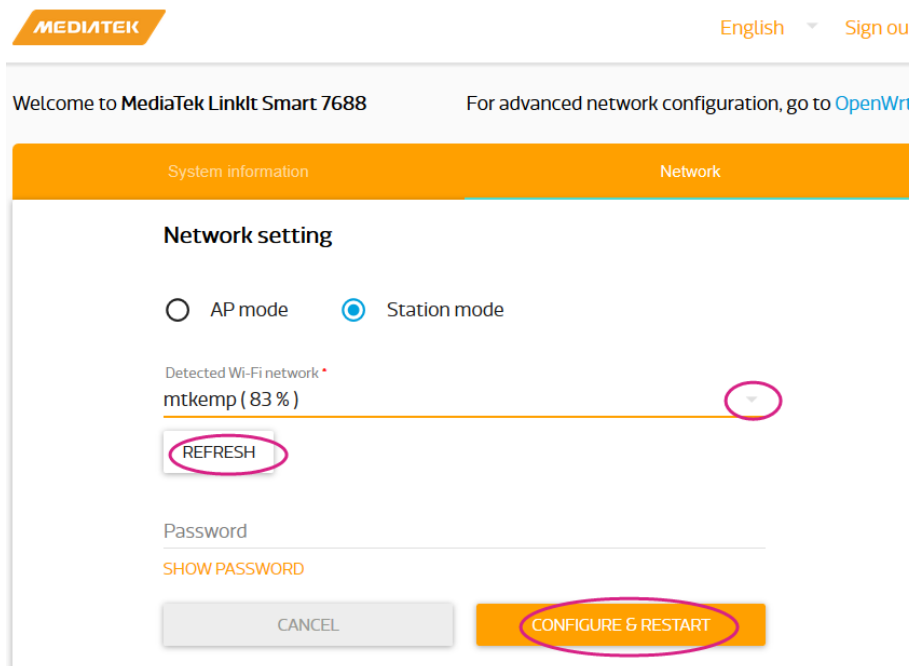

Figure 30 Changing to Station mode in Web UI

- 3) A message window will pop up letting you know the device is connecting to the AP you've selected and reload the Web UI page to sign in.
- 4) After you've signed in, check the Wi-Fi LED; it should blink once every two seconds, this indicates LinkIt Smart 7688 is in Station mode.
- 5) To change LinkIt Smart 7688 back to AP mode, press the Wi-Fi Reset button for at least 5 seconds and release. Please see 4.5.3, "Connecting to the Web UI" for details. Reload the Web UI and sign in. When you see three short blinks on Wi-Fi LED, it is in AP mode.

You can also use system console to change LinkIt Smart 7688 to AP mode, please see section 4.6.5.2, "Using the System Console".

#### 4.6.5.2. Using the System Console

In order for LinkIt Smart 7688 board to access the internet, it needs to join a network that has an access point connected to the internet, and to do that, the board needs to be in Station mode.

When a LinkIt Smart 7688 development board is in Station mode, it can install software from OpenWrt to the board using `opkg` command.

This section describes how to change LinkIt Smart 7688 to station mode using Unified Configuration Interface (UCI) in the system console.

- 1) Make sure the host computer is connected to the AP in a Wi-Fi network.
- 2) Get the following information from the AP that is in a Wi-Fi network:
  - o SSID Encryption type, refer to Table 14:

Encryption	UCI Command string
Open network	none
WPA-PSK	psk
WPA2-PSK	psk2
WEP	not supported

**Table 14 Wi-Fi AP Encryption Type**

For more information on encryption types please check [here](#).

- o Password
- 3) Open a system console and enter the following commands to change LinkIt Smart 7688 to station mode:

In this example, the following AP is used:

- AP SSID: **MyAP**
- Encryption type: **WPA2-PSK** ( psk2)
- Password: **12345678**

```
# uci set wireless.sta.ssid=MyAP
# uci set wireless.sta.encryption=psk2
# uci set wireless.sta.key=12345678
# uci set wireless.sta.disabled=0
# uci commit
# wifi
```

- 4) Now check if you've established network connection by typing the following command in the terminal window:

```
# ping -c 5 www.mediatek.com
```



If you see a screen similar to Figure 31, congratulations, you've connected to the Wi-Fi network's AP. The Wi-Fi LED will blink once every two seconds indicating Station mode.

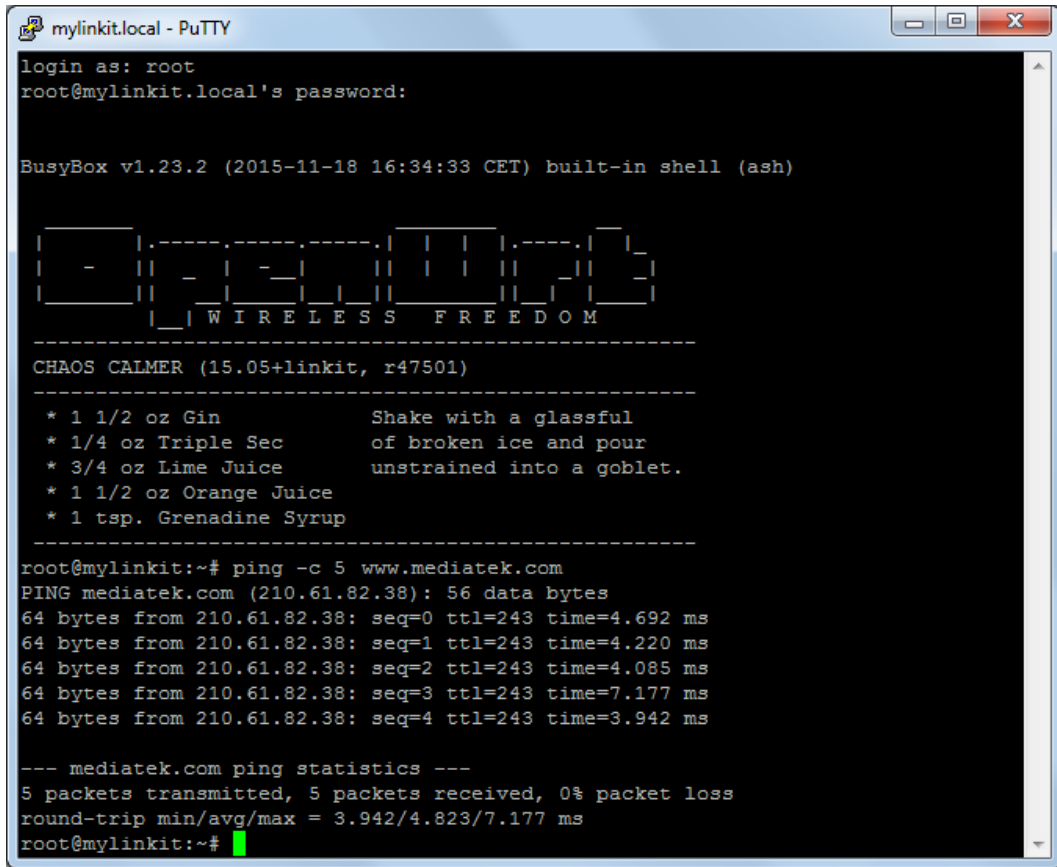

*Figure 31 LinkIt Smart 7688 in Station mode connected to a Wi-Fi AP*

### 4.6.6. Viewing System Information from the Web UI

You can view LinkIt Smart 7688's system information from any browser. After you've connected the LinkIt Smart 7688 to a network, open a browser and type **http://mylinkit.local** in the URL box and sign in, click the **Configure** button under System information and the following information will display, as shown in Figure 32:

- Device name
- Current IP address
- Account
- Password

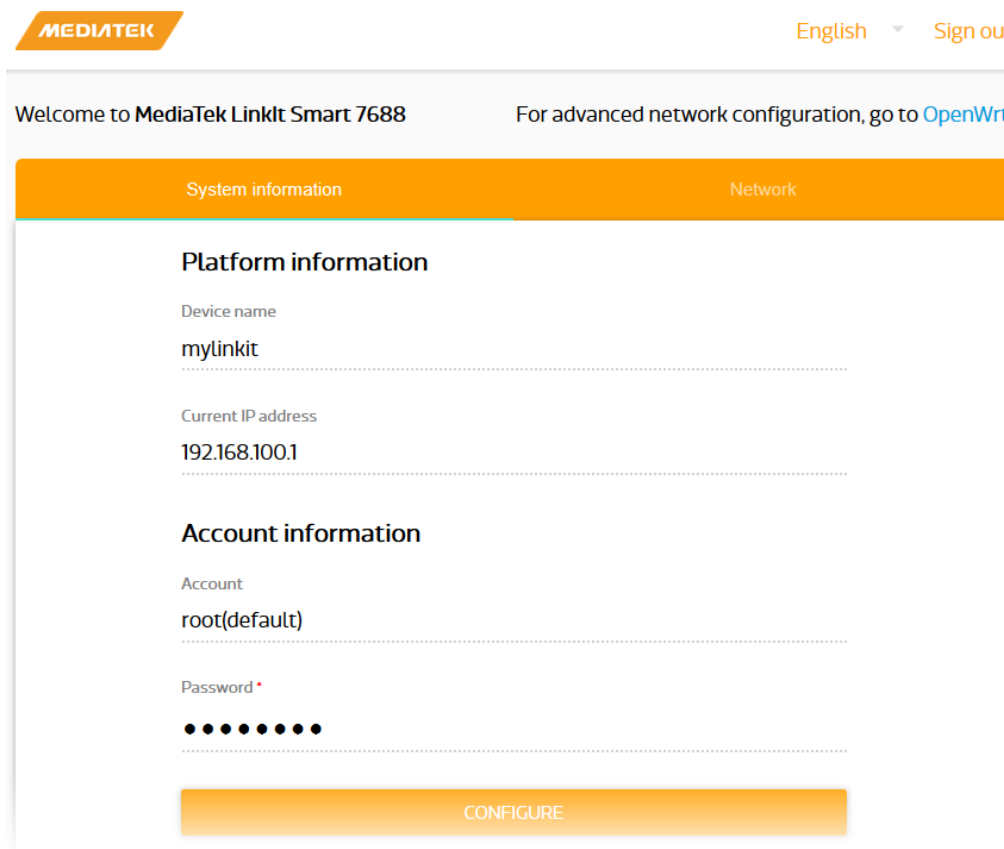

Figure 32 System Information in LinkIt Smart 7688 Web

### 4.6.7. Accessing the USB drive and the SD Card

When a USB drive or SD card is inserted into LinkIt Smart 7688, they can be accessed under **/Media/SD\*** or **/Media/USB\*** (The device name displayed varies depending on the number of drives you use and the number of partitions available on the USB drive or SD card).

You can use the following commands to check the contents of the USB drive and SD card:

- In this example, a USB drive named USB-A1 is used:

```
> ls /Media/USB-A1
```

- In this example, a SD card named SD-P1 is used:

```
> ls /Media/SD-P1
```

## 4.7. File Editor and Transfer

As a developer, you want freedom to use any text editor of your choice for coding. You can launch the built-in *vim* editor in system console to edit source code files directly in LinkIt Smart 7688 or you can use other editor from a remote computer, but during development, including tasks such as program execution, it's common to transfer files between LinkIt Smart 7688 and the remote programming computer to finish the job. The default system image of LinkIt Smart 7688 provides several tools for transferring files over Wi-Fi connection. Table 15 shows the types of file transfer tools:

File Transfer Service	Protocol	Host Platform	Tool
SCP (Secure Copy)	SCP	Windows	<a href="#">WinSCP</a>
		OS X	scp command
		Linux	scp command
Samba	SMB/CIFS	Windows	File Explorer built-in support
		OS X	Finder built-in support
		Linux	smbclient

**Table 15 File Transfer Tools**

### 4.7.1. Using SCP to copy files in Windows:

SCP tool is one of the most reliable ways to transfer files through the SCP protocol. You can download tools that support SCP protocol. [WinSCP](#) is used in this guide. It provides both GUI and command line interfaces:

- a) To use GUI, start WinSCP and click **Yes** when you see a warning window as shown in Figure 33.

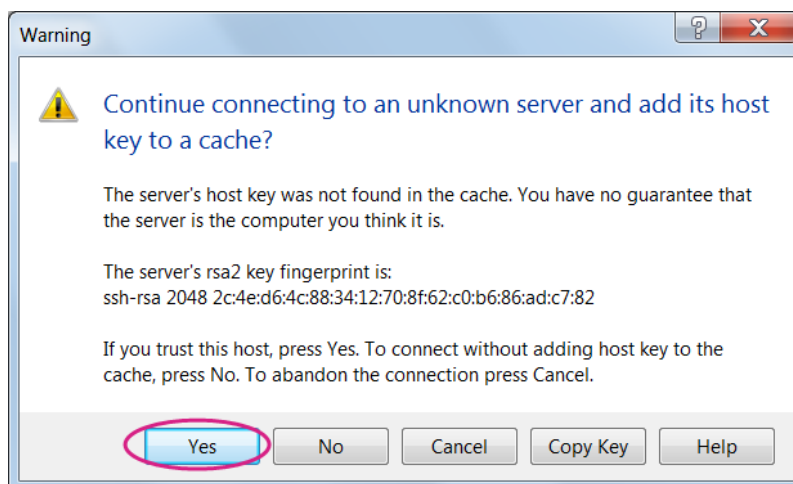

**Figure 33 SCP Security Warning**

- b) Select SCP for file protocol, enter **mylinkit.local** in the host name box, **root** for user name and password you set in Web UI. Click Login as show in Figure 34 .

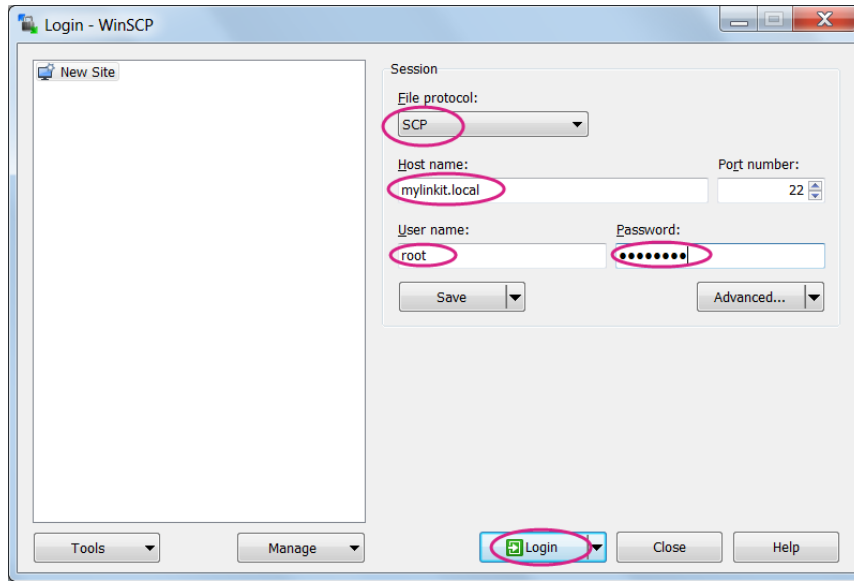

Figure 34 WinSCP login window

- c) Locate the file you want to transfer on the left pane (your computer) and drag it to the right (LinkIt Smart 7688), as shown in Figure 35.

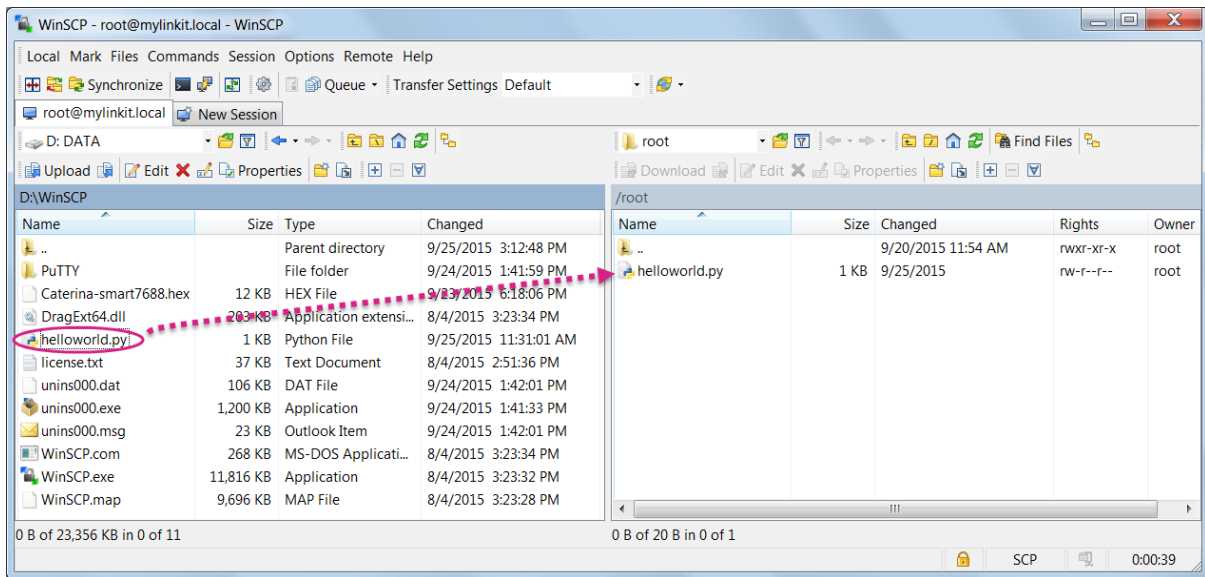
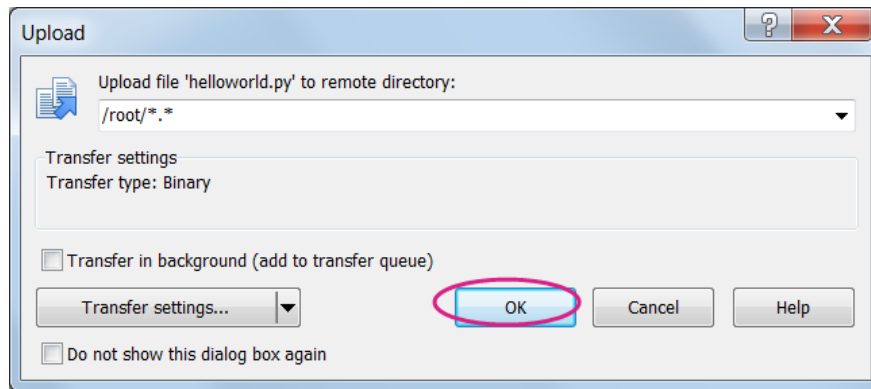

Figure 35 File transfer using WinSCP

- d) After you've dragged the file, an Upload window will appear as shown in Figure 36 asking you to confirm the upload. Click **OK**.



**Figure 36 File transfer confirmation**

Check the LinkIt Smart 7688 system console, the helloworld.py file should be there.

Alternatively you can use command line interface, by typing the following command in the Windows command line console:

```
winscp.com -hostkey="*" scp://root@myLinkt.local helloworld.py
```

Note that by default it requires user to explicitly designate the host key of remote server, so we need to explicitly allow unknown host key by adding the `-hostkey="*"` parameter.

### 4.7.2. Using SCP to copy files in OS X

In OS X, SCP command line tool should be already installed and ready to use. If it is not installed, you can use package managers such as [MacPorts](#) or [Homebrew](#) to install it. To use SCP, open the Terminal and issue following command:

```
scp ./helloworld root@mylinkit.local:/example/helloworld
```

In the above example, a file named helloworld from the current directory is copied to the path /example/helloworld in LinkIt Smart 7688. The SCP tool will instruct you to enter the password of root account, which is setup in section 4.5.1, "System Configuration Tools".

### 4.7.3. Setup Samba service in LinkIt Smart 7688

Samba is a file transfer tool that is built-in LinkIt Smart 7688 and provides a shared folder /Media on the device for file transfer. In the example below you'll learn how to use UCI command to change the shared folder to /IoT and set appropriate access permission for this folder.

- 1) Change the shared folder path to /IoT. In LinkIt Smart 7688 console, type the following command:

```
# uci set samba.media.path='/IoT'
```

2) Name the shared folder MySharedFolder, for example:

```
# uci set samba.media.name='MySharedFolder'
```

3) Change the permission of the shared folder to make it readable and writable, for example:

```
# chmod o+rwx /IoT
```

4) Save and reboot the LinkIt Smart 7688 platform, for example:

```
# uci commit
# reboot
```

5) After LinkIt Smart 7688 reboots and is connected to the same local network as your computer, you are ready to use the Samba transfer tool. Check the steps according to your operating system below.

#### 4.7.4. Use Samba to copy files in Windows

Open file explorer and type \\mylinkit.local, you should see the MySharedFolder. Open another file explorer, drag and drop your file to MySharedFolder, as shown in Figure 37.

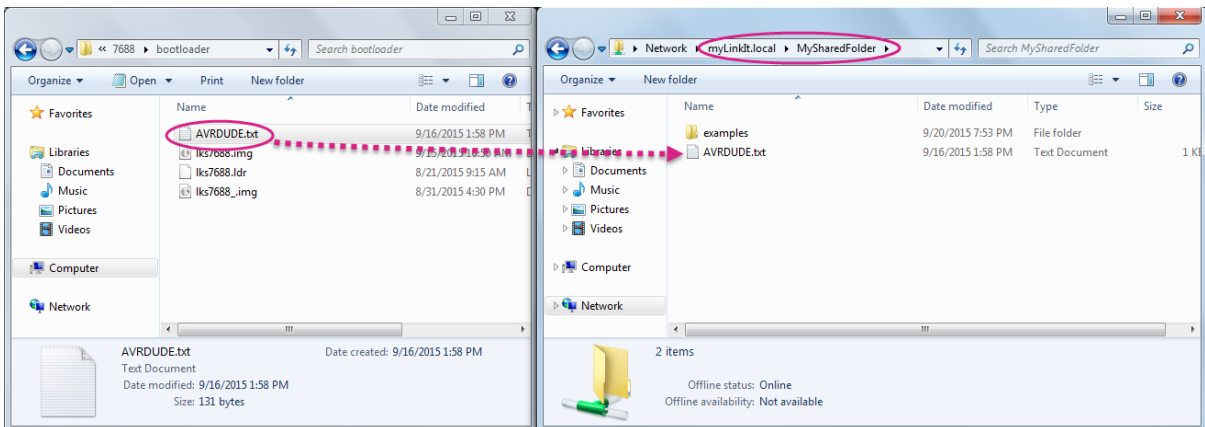

Figure 37 File transfer using Samba in Windows

(The remainder of this page is intentionally left blank)

### 4.7.5. Use Samba to copy files in OS X

The steps to transfer files using Samba in Mac are as follows:

- 1) Open Finder and in the top menu click Go > Connect to server as shown in Figure 38.

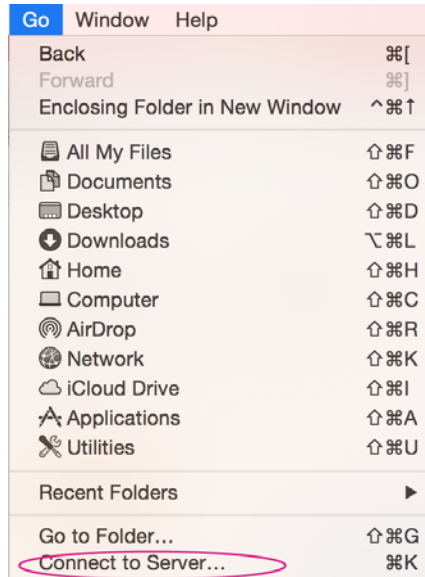

Figure 38 Connecting to LinkIt Smart 7688 from Finder

- 2) In the server address field, type **smb://mylinkit.local** and click **Connect**, as shown in Figure 39.

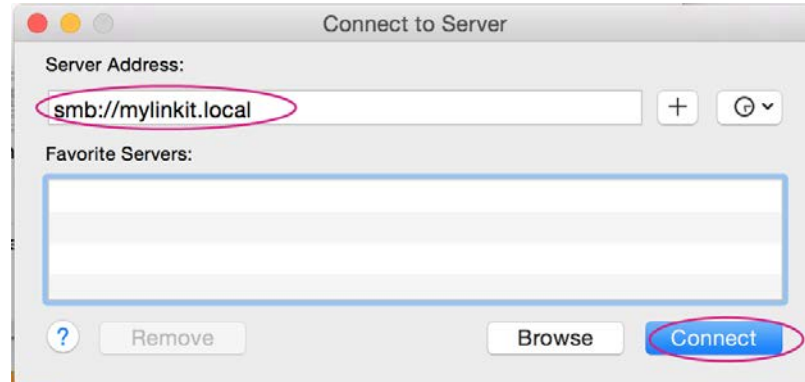
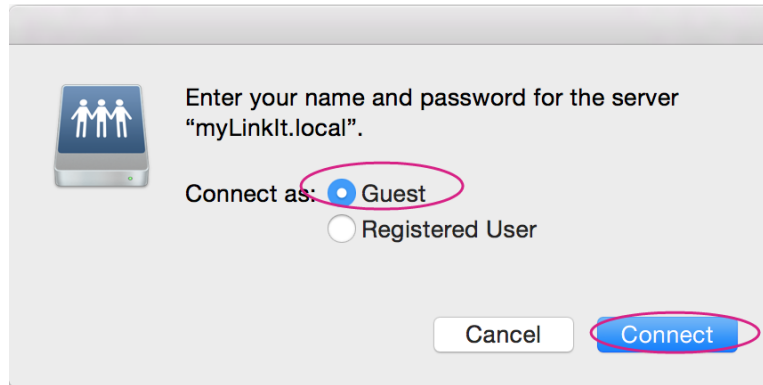

Figure 39 Connecting to mylinkit.local server in Mac

3) Connect as guest, as shown in Figure 40.



**Figure 40 Connecting as guest to mylinkit.local on Mac**

4) Check Finder and you'll see MySharedFolder as shown in Figure 41. You can now transfer files in this folder.

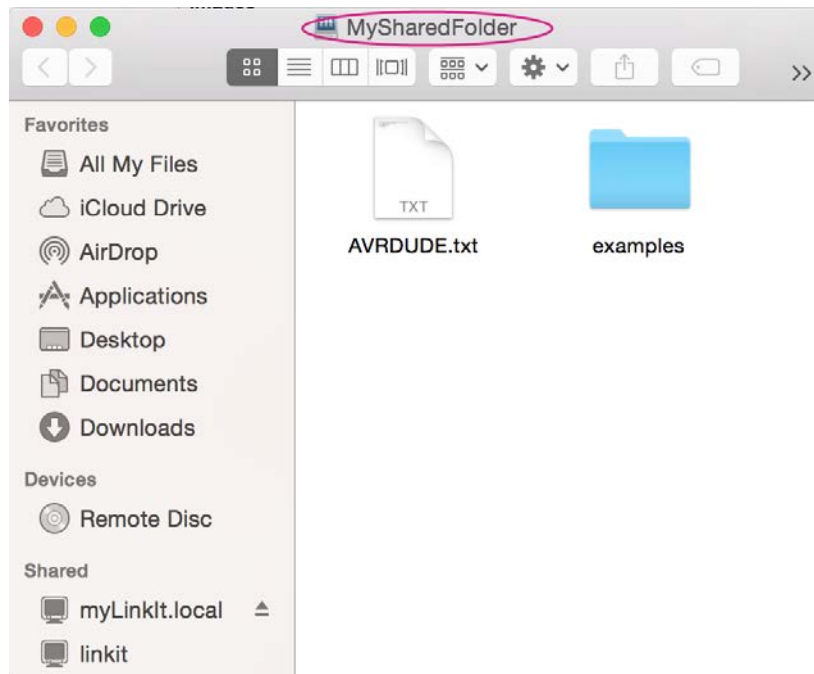

**Figure 41 MyShareFolder in Mac Finder**

(The remainder of this page is intentionally left blank)



## 5. Peripheral Programming on LinkIt Smart 7688

This chapter describes how to program the peripheral sensors on the LinkIt Smart 7688 board.

From the hardware aspect, MediaTek MT7688AN SOC on the LinkIt Smart 7688 board handles all the Wi-Fi communication, USB device control, SD card access and sensor connection. As shown in Figure 42. Related software stacks are provided for developers to access the sensors attached to the MT7688AN.

UPM is the repository for sensor drivers written in libmraa and it provides API bindings for Python, Node.js and C languages. So it's convenient for developers to use UPM to access peripheral sensors and modules with the programming language that they preferred. LinkIt Smart 7688 has built-in UPM support. The detailed support list of sensors in UPM can be found in the [UPM project page](#).

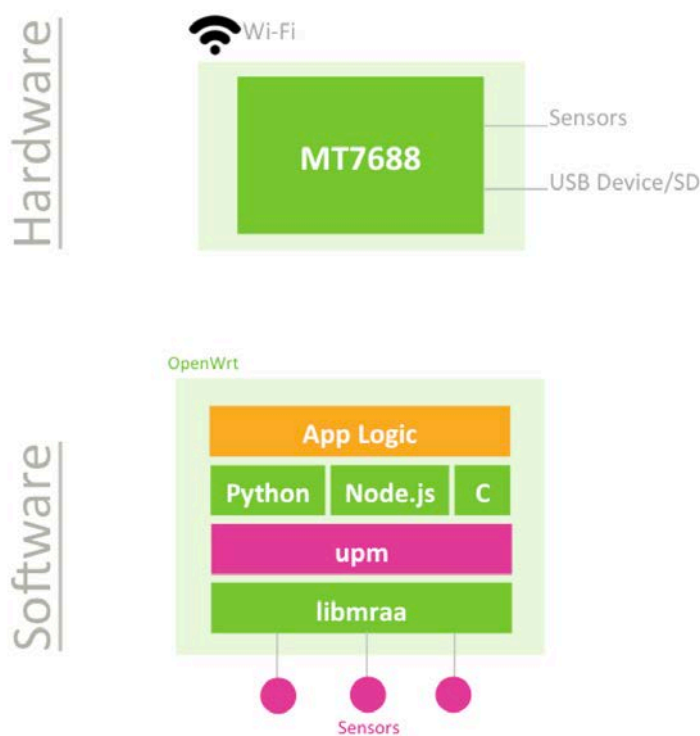

Figure 42 LinkIt Smart 7688 Software Architecture

### 5.1. How to Access LinkIt Smart 7688 Peripheral using MRAA

Libmraa is a C/C++ library to interface with the peripheral on LinkIt Smart 7688. Libmraa is pre-installed in the system image of LinkIt Smart 7688 and supports Python, Javascript and Node.js languages. This section describes how to control LinkIt Smart 7688 peripherals such as GPIO through libmraa.

#### 5.1.1. Installing MRAA

Libmraa is already installed in the system image of LinkIt Smart 7688, so you don't need to install it again. However if you want to update the library, or want to port or upgrade the library, please refer to [libmraa](#) for more information.

To use libmraa in Python, you need to **import** it. In the below example, libmraa is imported and the output is the build version of the mraa:

```
import mraa
print (mraa.getVersion())
```

For a list of libmraa APIs, please see [here](#) for more information.

### 5.1.2. Basic concepts of libmraa

The majority of hardware modules such as GPIO, UART, SPI, and PWM are represented as objects created by mraa's factory function. These modules are initialized on certain pins that are identified by pin numbers. The pin numbers in the libmraa on LinkIt Smart 7688 are identical to the GPIO number in the data sheet and in the Linux GPIO subsystem.

The following example creates GPIO object on GPIO 2, which maps to P10 of LinkIt Smart 7688 and it's the IS2\_WS pin in data sheet, as shown in Table 16. Refer to the Pin-out diagram of LinkIt Smart 7688 to see the mapping between the silk print on the board and the GPIO number. This number also applies to Linux: /sys/class/gpio/2 which maps to exactly the same P10 pin on the LinkIt Smart 7688 board.

GPIO	Pin mapping
LinkIt Smart 7688	P10
Datasheet	IS2_WS

**Table 16 LinkIt Smart 7688 GPIO Pin Mapping**

```
import mraa
pin = mraa.Gpio(2) # Initialize GPIO2 (P10 on LinkIt Smart 7688 board)
```

### 5.1.3. Libmraa Main Functions

This section introduces major modules of libmraa to give you ideas about how to work with GPIOs and the other interfaces that are available on LinkIt Smart 7688.

- GPIO and Interrupts

To control GPIO pins, initialize the pin as GPIO pin and set its *mode*. The simplest operation mode is **OUTPUT** - set the pin to **HIGH** or **LOW** to enable and disable external switches or to form signal patterns.

```
import mraa
pin = mraa.Gpio(2) # Initialize GPIO2 (P10 on LinkIt Smart 7688 board)
pin.dir(mraa.DIR_OUT) # set as OUTPUT pin
```

Then, call `pin.write(0)` to set the pin state to **LOW** or call `pin.write(1)` to set the pin state to **HIGH**. To make the Wi-Fi LED blink periodically, set pin 44 (WLED\_N) to GPIO mode and execute the following code:

```
import mraa
import time

# Refer to the pinout digram for the GPIO number to silk print mapping
# in this example the number 44 maps to Wi-Fi LED.
pin = mraa.Gpio(44)
pin.dir(mraa.DIR_OUT)

while True:
    pin.write(1)
    time.sleep(1)
    pin.write(0)
    time.sleep(1)
```

There's another GPIO mode which is **INPUT**. It takes the digital signal input from the pin and interprets it into 1 and 0. This example will continuously print out the value received from P10 on the board. You can short 3V3 and P10 to observe the change in values.

```
import mraa
import time

# Refer to the pinout digram for the GPIO number to silk print mapping
# in this example the number 2 maps to P10 on LinkIt Smart 7688 board
pin = mraa.Gpio(2)
pin.dir(mraa.DIR_IN)

while True:
    print "P10 state:", pin.read()
    time.sleep(0.3)
```

Finally, an interrupt service routine can be installed to the pin and invoked when the values of the input pin P10 (GPIO2) has changed. Call `isr` API with the trigger type you want to register and the function to be called. Note that the function runs in a different thread.

```
import mraa
import time

def callback(userdata):
    print "interrupt triggered with userdata=", userdata

pin = mraa.Gpio(2)
pin.dir(mraa.DIR_IN)
pin.isr(mraa.EDGE_BOTH, callback, None)

while(True):
    time.sleep(1)
    # simply wait for interrupt
```

- **PWM**

Use PWM module to generate a *pulse width modulated* signal pattern. This is useful to control actuator peripherals such as servo motors. To use PWM, initialize it on a certain pin such as GPIO. Note that only GPIO18, GPIO19, GPIO20, GPIO21 supports PWM on LinkIt Smart 7688. To control the PWM pattern, several parameters are required, including:

- **Period**

This defines the carrier frequency of the modulation. It's controlled by `period`, `period_ms` and `period_us` APIs.

- **Duty Cycle or Pulse Width**

These two parameters are related to each other and usually you only need to set one of them. Duty cycle is controlled by `write` API with a value range between 0.0 to 1.0, where 0.0 is 0% of duty cycle and 1.0 is 100% of duty cycle. Pulse width also defines the pattern in a different unit: the "uptime" of the signal in time units. This is defined by `pulsewidth`, `pulsewidth_ms`, and `pulsewidth_us` APIs.

The following example generates a 500Hz PWM signal with 25% duty cycle on pin P26.

```
import mraa

pin = mraa.Pwm(18) # initialize on GPIO18 (pin P26)
pin.period_ms(2)  # set PWM frequency to 500Hz (2ms period)
pin.enable(True)  # enable PWM output
pin.write(0.25)   # set duty cycle to 25%
```

- **I2C**

I2C (Inter-Integrated Circuit) is a widely used protocol among peripherals. It consists of 2 signal pins - usually named SDA and SCL. LinkIt Smart 7688 comes with 1 set of I2C on GPIO4 (P21) and GPIO5 (P20) as SCL and SDA respectively.

The way I2Cs are initialized is slightly different from GPIO modules - instead of using *pins*, I2Cs are initialized according to its device index. Since there is only 1 set of I2C master device on LinkIt Smart 7688, you can simply pass 0 - and it is always on pin GPIO4 and GPIO5.

```
import mraa
i2c = mraa.I2c(0)
```

I2C is capable of connecting multiple slave devices to a single I2C master. Each slave device is identified by a 7-bit *address*. The following example scans for a Seeed Studio 3-Axis Digital Accelerometer attached to LinkIt Smart 7688 by reading the device ID from its registers.

```
import mraa

i2c = mraa.I2c(0)
# Grove - 3-Axis Digital Accelerometer(+16g)
# is a ADXL345 configured to I2C address 0x53.
i2c.address(0x53)
# The device ID should be
if 0xE5 == i2c.readReg(0x00):
    print "Grove - 3-Axis Digital Accelerometer found on I2C Bus"
else:
    print "Grove - 3-Axis Digital Accelerometer not found"
```

For more details on I2C API, please see [here](#).

To drive an I2C device, you need to operate multiple I2C sequences. LinkIt Smart 7688 also comes with libUPM pre-installed, which is a set of driver repository built upon libmraa. Please see [here](#) for a driver example of Seeed Studio 3-Axis Digital Accelerometer.

- **SPI**

SPI (Serial Peripheral Interface) can also be used to control peripheral devices. On LinkIt Smart 7688 it consists of 4 pins: SPI\_MOSI (P22), SPI\_MISO (P23), SPI\_CLK (P24), and SPI\_CS1 (P25).

It's important to note that the SPI device is also used for communicating with the internal flash storage on the board. Therefore, developers should access the SPI functionality through SPI modules only and avoid treating these SPI pins as general GPIO. Otherwise, the flash storage may work incorrectly.

The SPI module in libmraa is initialized by device index, instead of pin number.

```
import mraa
spi = mraa.Spi(0)
```

The SPI protocol allows flexible configurations on signal patterns. Depending on your peripheral, you may need to configure the pattern with APIs like `bitPerWord` and `mode`. Please see [here](#) for API details.

#### 5.1.4. LED blink example using mraa in LinkIt Smart 7688 GPIO in Python

This example shows you how to use mraa library in Python to make the Wi-Fi LED on LinkIt Smart 7688 blink.

- 1) In LinkIt Smart 7688 SSH system console, create a directory called `app` and go to that directory. For example:

```
# mkdir app
# cd app
```

- 2) In the root@mylinkit:~/app# prompt, create a file named blink.py by entering the following command.

```
# vim blink.py
```

- 3) Press **i** to insert the below codes in the editor. For example:

```
import mraa
import time
# Refer to the pinout digram for the GPIO number to silk print mapping
# in this example the number 44 maps to Wi-Fi LED
led = mraa.Gpio(44)
led.dir(mraa.DIR_OUT) # set direction to output

while True:
    led.write(1)      # turn on LED
    time.sleep(1)
    led.write(0)     # turn off LED
    time.sleep(1)
```

- 4) Press **Esc** key and **:wq!** to save the blink.py file.
- 5) Now you're ready to run this Python application. In the app directory, type following command to run the app:

```
# python ./blink.py
```

The Wi-Fi LED on LinkIt Smart 7688 should blink every second.

Press **<Ctrl> C** to terminate the Python program.

### 5.1.5. LED blink example using mraa in LinkIt Smart 7688 GPIO in Node.js

This example shows you how to use mraa library in Node.js to make the Wi-Fi LED on LinkIt Smart 7688 blink.

- 1) Connect to LinkIt Smart 7688 console using SSH. In the system console, create a directory called app and then switch into the directory. For example:

```
# mkdir app
# cd app
```

- 2) Use NPM to initialize your file. NPM is a package manager for Node.js and is pre-installed in LinkIt Smart 7688. You can install it from [here](#) just in case.

```
# npm init
```

- 3) After about 10 seconds, you'll be prompted to enter several inputs such as a name for app, version and description etc. as shown in Figure 43. This is a setup process for the Node.js application. For this tutorial, press enter for all questions.

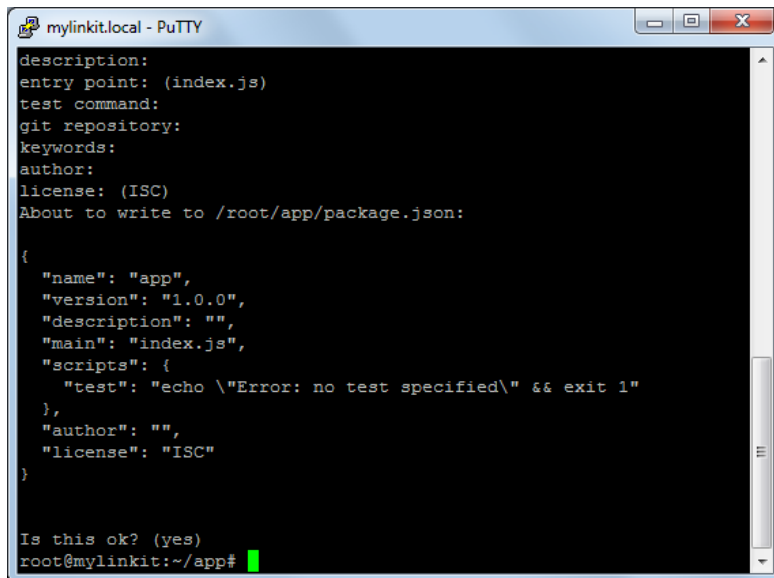

```

mylinkit.local - PuTTY
description:
entry point: (index.js)
test command:
git repository:
keywords:
author:
license: (ISC)
About to write to /root/app/package.json:

{
  "name": "app",
  "version": "1.0.0",
  "description": "",
  "main": "index.js",
  "scripts": {
    "test": "echo \"Error: no test specified\" && exit 1"
  },
  "author": "",
  "license": "ISC"
}

Is this ok? (yes)
root@mylinkit:~/app#
    
```

*Figure 43 Set up the Node.js application prompt*

- 4) In the root@mylinkit:~/app# prompt, create a file named app.js by entering the following command.

```
# vim app.js
```

- 5) Press **i** to insert the below codes in the editor. For example:

```

var m = require('mraa');
var ledState = true;
var myLed = new m.Gpio(44); // GPIO44 is the Wi-Fi LED

myLed.dir(m.DIR_OUT);

function periodicActivity() {
  myLed.write(ledState ? 1 : 0);
  ledState = !ledState;
  setTimeout(periodicActivity, 1000);
}
periodicActivity();
    
```

Press **Esc** key and **:wq!** to save the app.js file.

- 6) Now you're ready to run this Node.js application. In the app directory, type following command to run app.js:

```
# node app
```

The W-Fi LED on LinkIt Smart 7688 should blink every second.

Press **<Ctrl> C** to terminate the program.

## 5.2. How to use UPM to access sensors and peripherals

[UPM](#) is an open source sensor and peripheral driver repository based on libmraa APIs. Among the popular sensor drivers such as I2C accelerometers and many others are available from this repository.

LinkIt Smart 7688 system image is pre-installed with UPM and you can start programming on existing sensors immediately – but if the default implementation is not available, you can use opkg package manager to update the UPM library.

UPM is similar to libmraa in the way that it comes with bindings in C++, Python and Node.js. Let's get started with an example where you'll learn how to use UPM and Python to receive values from an I2C accelerometer – a Grove 3-Axis Digital Accelerometer ( $\pm 16g$ ).

- 1) Connect the Accelerometer to your board. If you have the breakout board, you can attach it to the I2C grove interface. If not, you can also connect the pins from the accelerometer to the corresponding pins GND, 3V3, SDA (P20) and SCL (P21) on LinkIt Smart 7688 board.
- 2) Import `pyupm_adxl345` module from the UPM repository in your program, you'll do this in the next step. This module is used because the Grove 3-Axis Digital Accelerometer ( $\pm 16g$ ) uses the ADXL345 chipset.
- 3) Create a Python script `adx1.py` with following content:

```
import pyupm_adxl345 as adxl
import time

device = adxl.Adxl345(0)

while True:
    device.update()
    a = device.getAcceleration()
    print "(x,y,z)=%5.1f, %5.1f, %5.1f" % (a[0], a[1], a[2])
    time.sleep(0.3)
```

- 4) Execute the Python script in system console by typing the following command:

```
# python adx1.py
```

You should see the acceleration value printed repeatedly. Try moving the sensor around to see changes in the values – now you can use the sensor to detect accelerations.

For a list of other available Python modules in UPM repository, check [here](#). The UPM repository also comes with a handful of [examples](#) for your reference.



## 6. Peripheral Programming on LinkIt Smart 7688 Duo

This chapter describes how to program the peripheral sensors connected to the ATmega32U4 microcontroller and how to communicate between the microcontroller and the MT7688AN, as shown in Figure 44.

A few key things to be aware of include: the majority of peripherals, including sensors with I2C and SPI interface are connected to the ATmega32U4 microcontroller on LinkIt Smart 7688 Duo and the microcontroller on LinkIt Smart 7688 Duo is preloaded with bootloader that supports Arduino IDE programming. Therefore, the following sections will begin with introduction on how to setup the Arduino IDE, then, describe the basic ideas of communicating between MT7688AN and ATmega32U4, followed by some examples of different programming models that can be used to develop the application logic.

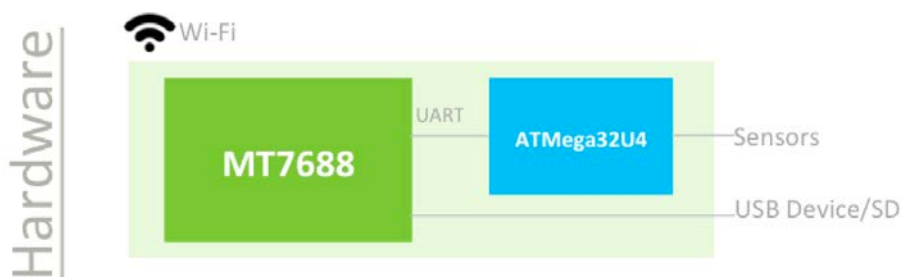

Figure 44 LinkIt Smart 7688 Duo Hardware Architecture

### 6.1. Installing Arduino IDE

LinkIt Smart 7688 Duo's MCU (ATmega32U4) can be programmed using Arduino IDE 1.6.5 and Arduino IDE board support package. You can install Arduino IDE 1.6.5 on your computer from [here](#).

### 6.2. Installing Board Support Package

Arduino IDE 1.6.5 supports third party board integration using the **Board Manager** tool. LinkIt Smart 7688 Duo development board is a plug-in to Arduino IDE and you'll need to install the board package so that Arduino supports LinkIt board. Please follow the steps below:

- 1) In Arduino IDE, on the **File** menu click **Preferences** then insert [http://download.labs.mediatek.com/package\\_mtk\\_linkit\\_smart\\_7688\\_index.json](http://download.labs.mediatek.com/package_mtk_linkit_smart_7688_index.json) to the **Additional Boards Manager URLs** field as shown Figure 45:

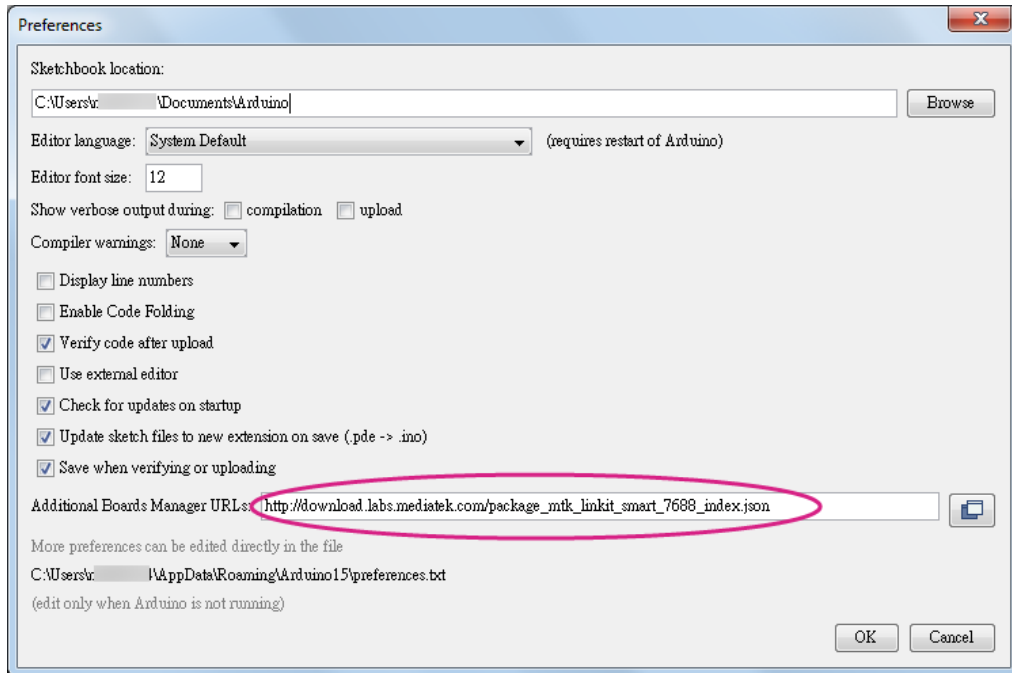

**Figure 45 LinkIt Smart 7688 Duo package URL for a custom board installation in Arduino IDE**

- 2) Make sure your computer is connected to the internet.
- 3) In the Arduino Tools menu point to Board then click Boards Manager as shown in Figure 46.

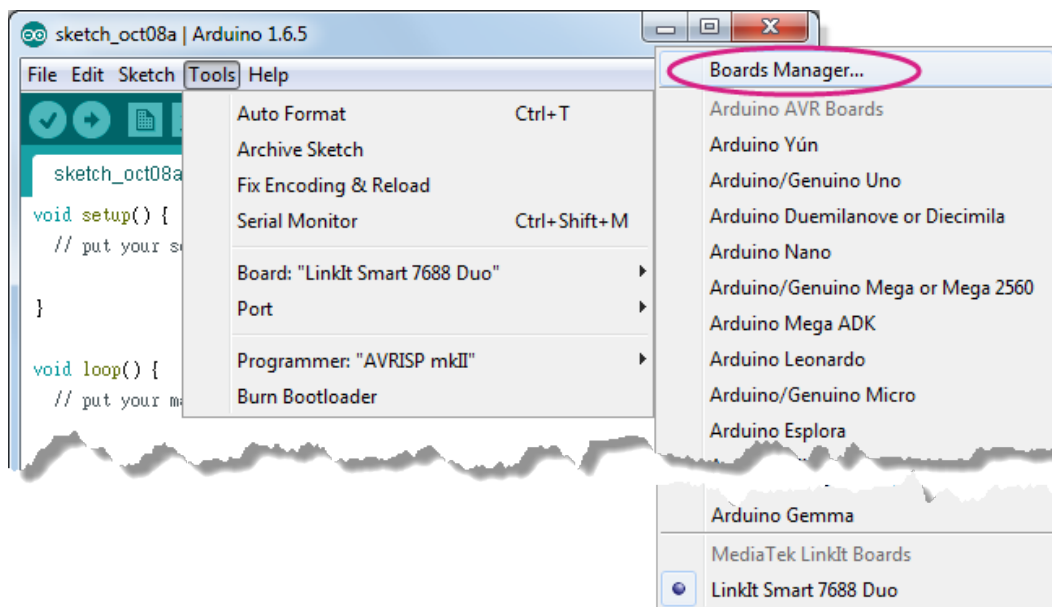

**Figure 46 Arduino IDE Board Manager Menu**

- 4) LinkIt Smart 7688 Duo board support package starts downloading automatically and it may take several seconds for the Boards Manager to download the repository.

If there is a downloading error (see below), remove the cached .json file. The location of the cached .json file is the same as the location of the preferences.txt file. It can be found in the Arduino IDE under the **File** menu by clicking **Preferences**.

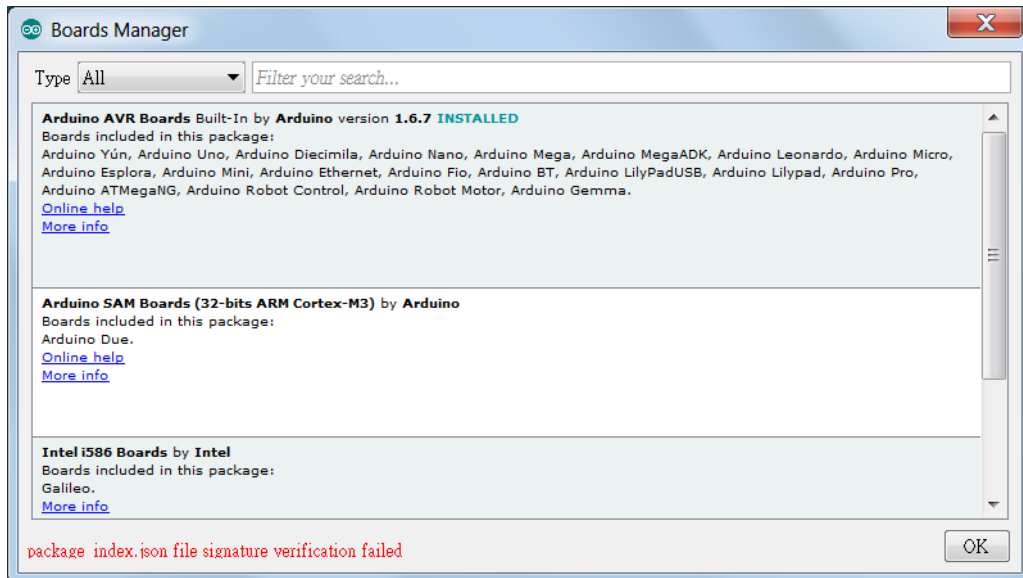

*Error downloading the LinkIt ONE SDK package*

- 5) There should now be a LinkIt Smart Boards appearing in the boards list on the Boards Manager as shown in Figure 47. Click the “version” button to select the latest and click Install.

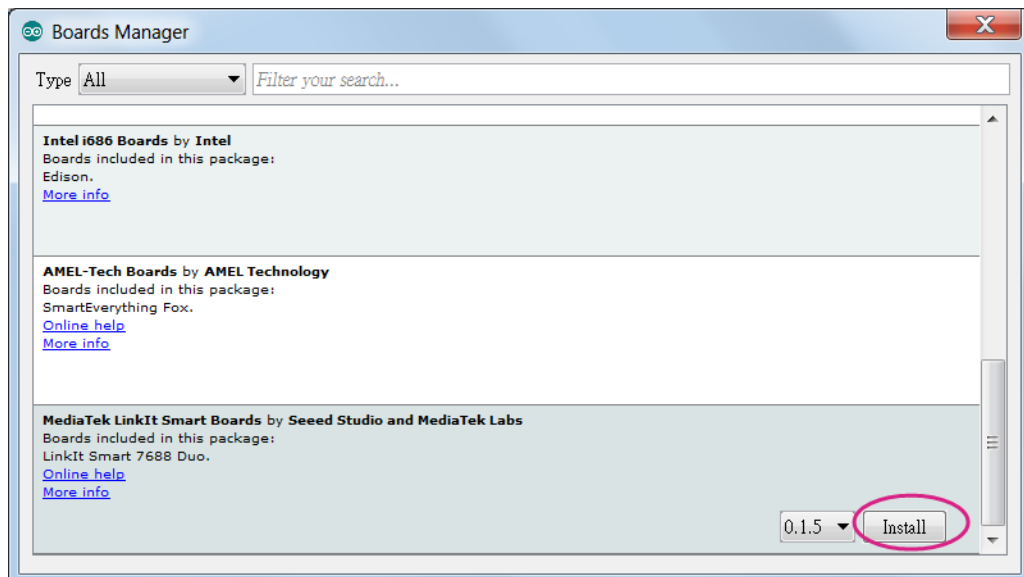

*Figure 47 LinkIt Smart 7688 Board Package Menu*

6) The installation completes, as shown in Figure 48.

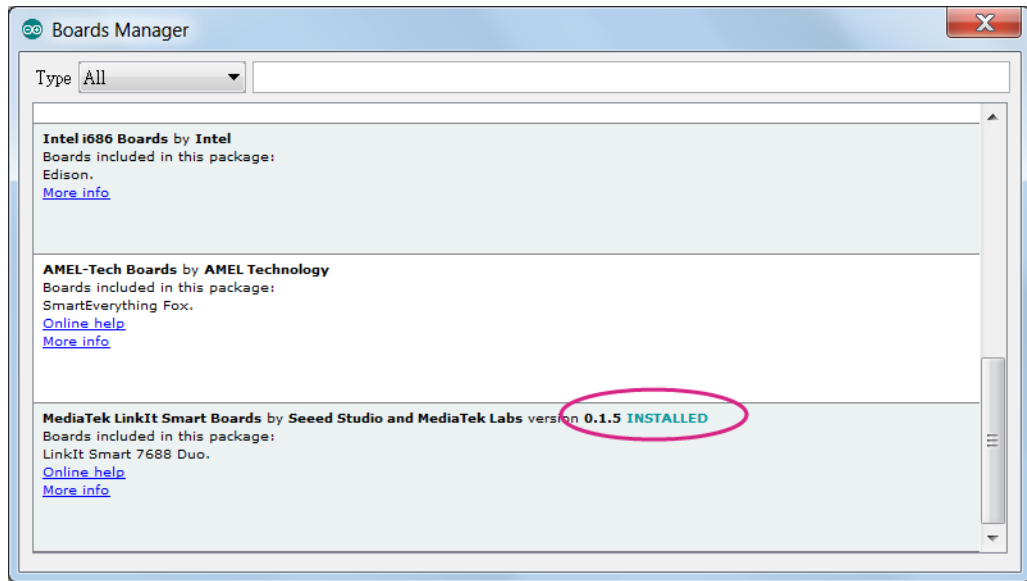
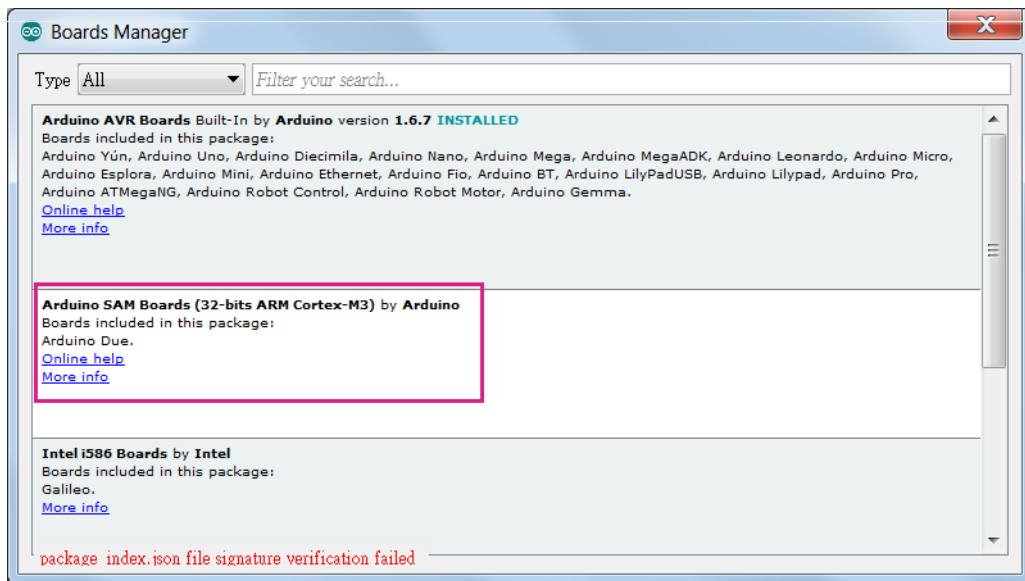

Figure 48 LinkIt Smart 7688 Duo board package installed on Arduino IDE

If there is a problem with the LinkIt Smart 7688 Duo board package installation, try installing Arduino SAM board package first, as shown below. Then retry LinkIt Smart 7688 Duo installation.



Problem downloading the SDK after the cached .json file is removed

7) You now have the LinkIt Smart 7688 Duo installed on Arduino IDE as show in Figure 49.

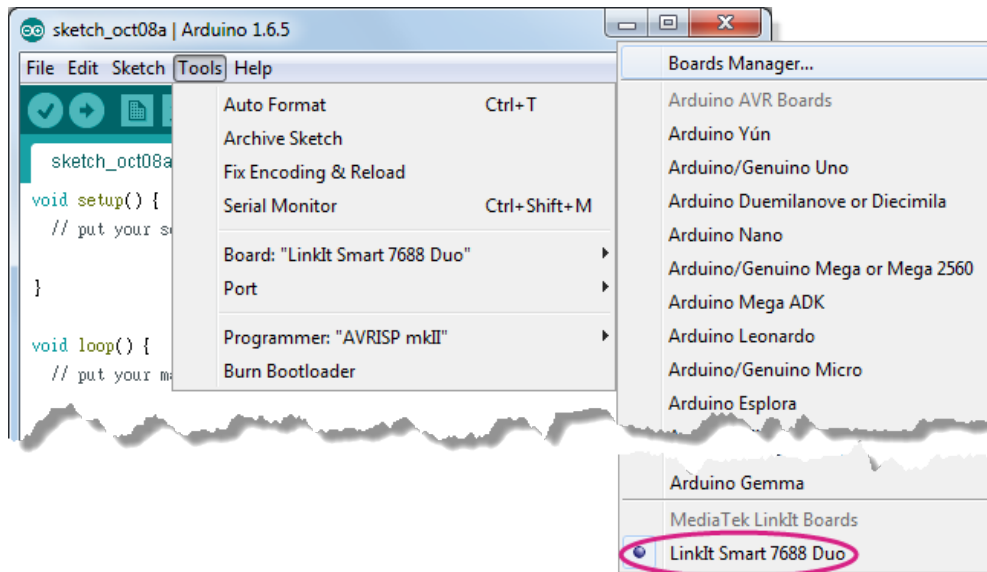

Figure 49 LinkIt Smart 7688 Duo installed on Arduino IDE

### 6.3. Installing LinkIt Smart 7688 Duo COM Port Driver

After you've installed the board package, connect LinkIt Smart 7688 Duo to your computer and you should see a USB serial COM port in the device manager with the following port ID:

- Bootloader COM port: VID=0x0E8D, PID=0xAB00
- Arduino Sketch COM port: VID=0x0E8D, PID=0xAB01

Next, you'll need to install drivers depending on your operating system. The steps are:

- For Windows 10, there is no need to install a driver. However, extra steps are needed to ensure Windows 10 recognizes the board. Connect LinkIt Smart 7688 Duo to your Windows 10 machine, then quickly press the MCU reset button **twice** within 700 milliseconds. The system should now recognize LinkIt Smart 7688 Duo as a USB Serial Device (COM5). The number 5 may be different on different machines. You only need to do this during the 1<sup>st</sup> time connecting the board to your Windows machine.
- For Windows 8, the system may block the driver installation. Follow this [link](#) to find out how to disable driver signature enforcement on Windows 8. After the signature enforcement is disabled, follow the steps for Windows 7 below to install the driver.
- For Windows 7, find the Serial COM port INF driver in the following path. You can also install it from [here](#).

{ARDUINO\_IDE\_PREFERENCE\_LOCATION}Arduino15/packages/LinkIt/hardware/avr/0.1.5/driver/linkit\_smart\_7688.inf

You'll find the Arduino preference location at File > Preferences, see the preference.txt path as shown in Figure 50.

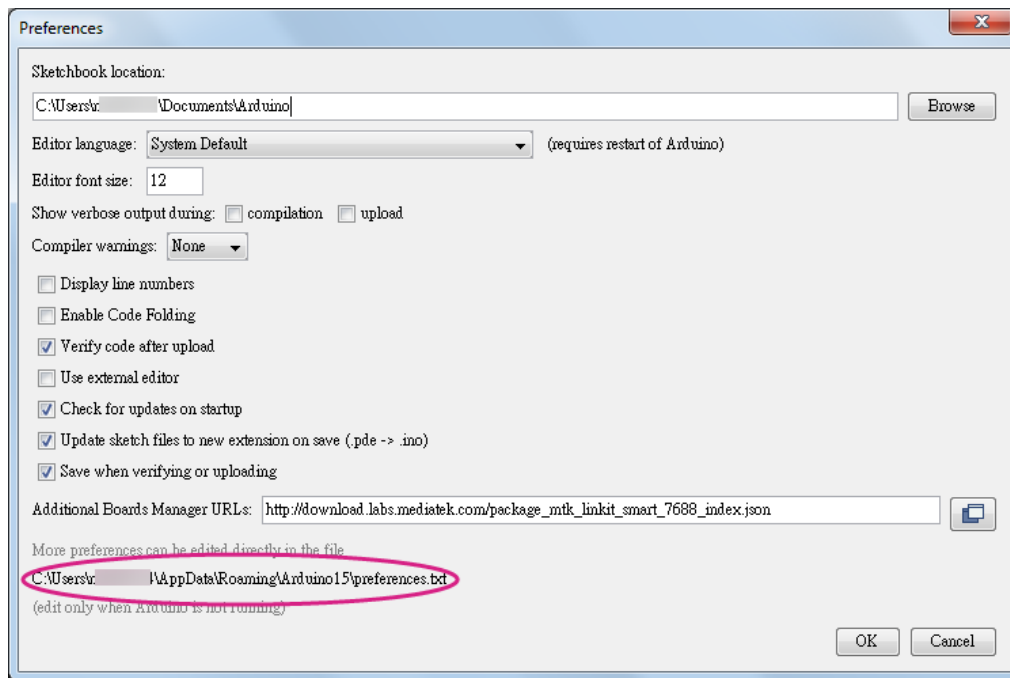

Figure 50 Arduino Preference Location

Right click on the linkit\_smart\_7688.inf and select install, a security windows appears and click **Install this driver software anyway**. As shown in Figure 51. This completes the driver installation.

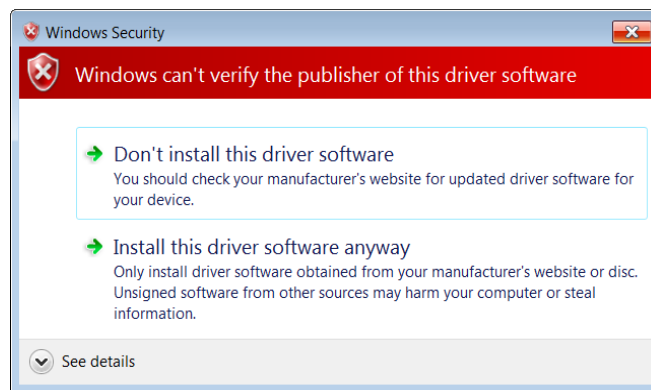

Figure 51 Driver installation

- For Ubuntu Linux, it should work without installing a driver. LinkIt Smart 7688 Duo should be in /dev folder and mounted as ttyUSB0. The number 0 may be different on each Ubuntu machine.
- For OS X, it's also not required to install a driver, LinkIt Smart 7688 Duo is mounted as a serial device under /dev/tty.usbmodem1413. The number 1413 may be different on each OS X machine.

## 6.4. Programming model for LinkIt Smart 7688 Duo

On LinkIt Smart 7688 Duo, MT7688AN is in charge of the Wi-Fi communication, USB device control and SD card access. As for sensor and peripheral module connections, ATmega32U4 is used for

better responsiveness in real-time control. The programming model used for MCU control is by Arduino programming through Arduino IDE, as shown in Figure 52. Depending on different applications and approaches in programming, three scenarios are listed for your reference for building your software system.



Figure 52 Smart 7688 Duo Hardware Architecture

**Scenario #1: Through primitive UART connection**

Since MT7688AN and ATMega32U4 are connected through a UART port, you can issue commands from the application written in Python, Node.js, or C through the UART channel to the MCU side, as shown in Figure 53. On the MCU side, you implement the codes to interpret commands from MPU and perform corresponding actions by accessing sensor drivers.

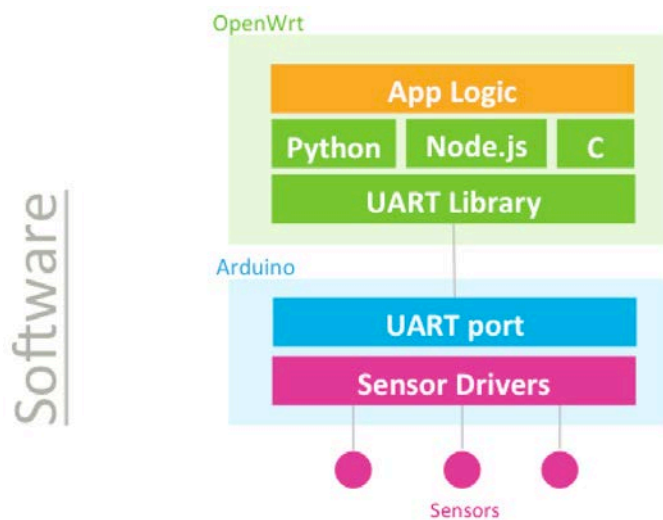

Figure 53 Software architecture

**Scenario #2: Through Firmata protocol**

In the above scenario #1, you'll need to implement the commands on the UART channel; this provides the most general, flexible and powerful way to realize the interaction between MPU and MCU. However, this also means you need to do the programming on both MPU and MCU side, which might increase the complexity for the software development.

In order to reduce the complexity of the UART command implementation, Firmata protocol is proposed as a solution. Firmata is a communication protocol between a MCU and a MPU and many Firmata implementations has been used to date. Therefore, those whom are familiar with MPU programming in Python, Node.js and C can choose a language they prefer to use Firmata to run the MPU and the MCU communication without having to deal with details of the UART command implementation and MCU side programming, as shown in Figure 54. For example, [Cylon.js](#) is a popular Node.js framework for Robotics application. It uses Firmata to implement the communication between MPU and MCU and thus alleviates Node.js developers from low level UART and MCU programming.

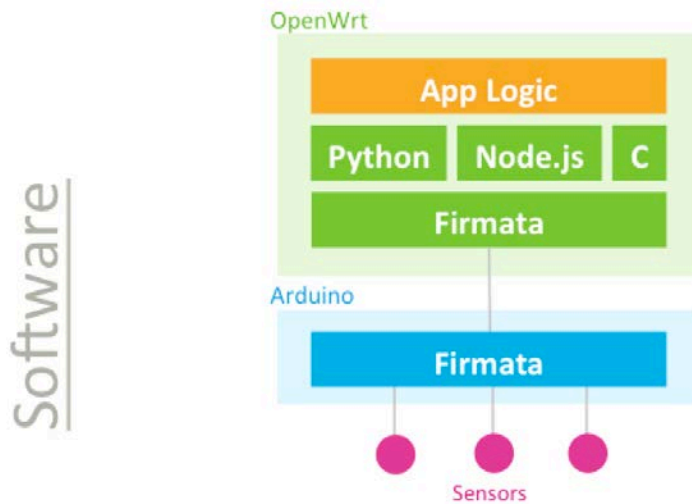

Figure 54 Firmata Protocol

### Scenario #3: Through Arduino Yun Bridge Library

For Arduino Yun developers, the MPU Linux side acts as a black box for simply providing Wi-Fi connectivity and USB / SD peripheral accessibility. LinkIt Smart 7688 Duo also provides Arduino Yun Bridge library implementation for developers to build their projects the way they are familiar with, as shown in Figure 55. This gives developers not only a familiar way to do development but also access to a more stable, powerful and energy efficient platform that MT7688AN can deliver.

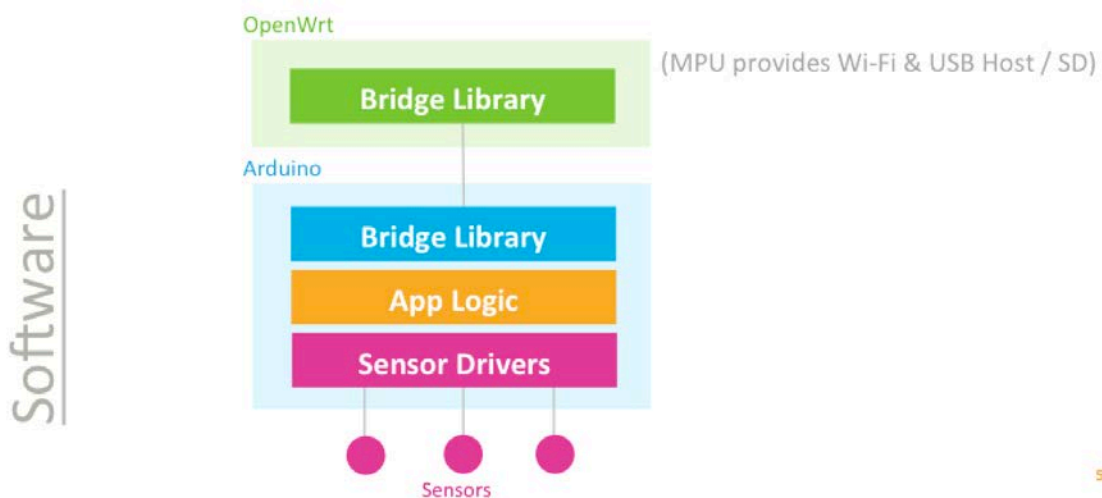

Figure 55 Yun Bridge Library



## 6.5. Programming with Primitive UART Connection

In all the scenarios described in previous section, the MPU and MCU on LinkIt Smart 7688 Duo communicates using Serial port. The MCU communicates with OpenWrt Linux over UART hardware. Table 17 illustrates the communication between MCU and MPU:

MCU		MPU	
In Arduino	Serial1	In Linux	/dev/ttyS0
Corresponding Pins	D0 and D1	Pin MUX	UART0 (GPIO12 and GPIO13)

*Table 17 MCU and MPU Communication*

In the following section an example is provided to demonstrate how to communicate between the MCU and MPU side by writing to and reading from the primitive UART connection.

### 6.5.1. Blink Program - Arduino Side

The MCU side is written as an Arduino sketch. In this example, the sketch simply listens to the command sent from the MPU (Linux) side and switches the on-board LED accordingly.

- 1) First, connect the LinkIt Smart 7688 Duo to your PC, then open Arduino IDE and paste the following sketch code into the IDE:

```
void setup() {
  Serial.begin(115200); // open serial connection to USB Serial port
  (connected to your computer)
  Serial1.begin(57600); // open internal serial connection to MT7688AN
  // in MT7688AN, this maps to device
  pinMode(13, OUTPUT);
}

void loop() {
  int c = Serial1.read(); // read from MT7688AN
  if (c != -1) {
    switch(c) {
      case '0': // turn off D13 when receiving "0"
        digitalWrite(13, 0);
        break;
      case '1': // turn off D13 when receiving "1"
        digitalWrite(13, 1);
        break;
    }
  }
}
```

- 2) Then choose the correct COM port from the IDE (check your device manager) by clicking Tools > Port.

- 3) Upload the sketch to the board as shown in Figure 56. Note the board is not blinking yet – you'll need to write a program in the Linux side to make it blink, which is the next step.

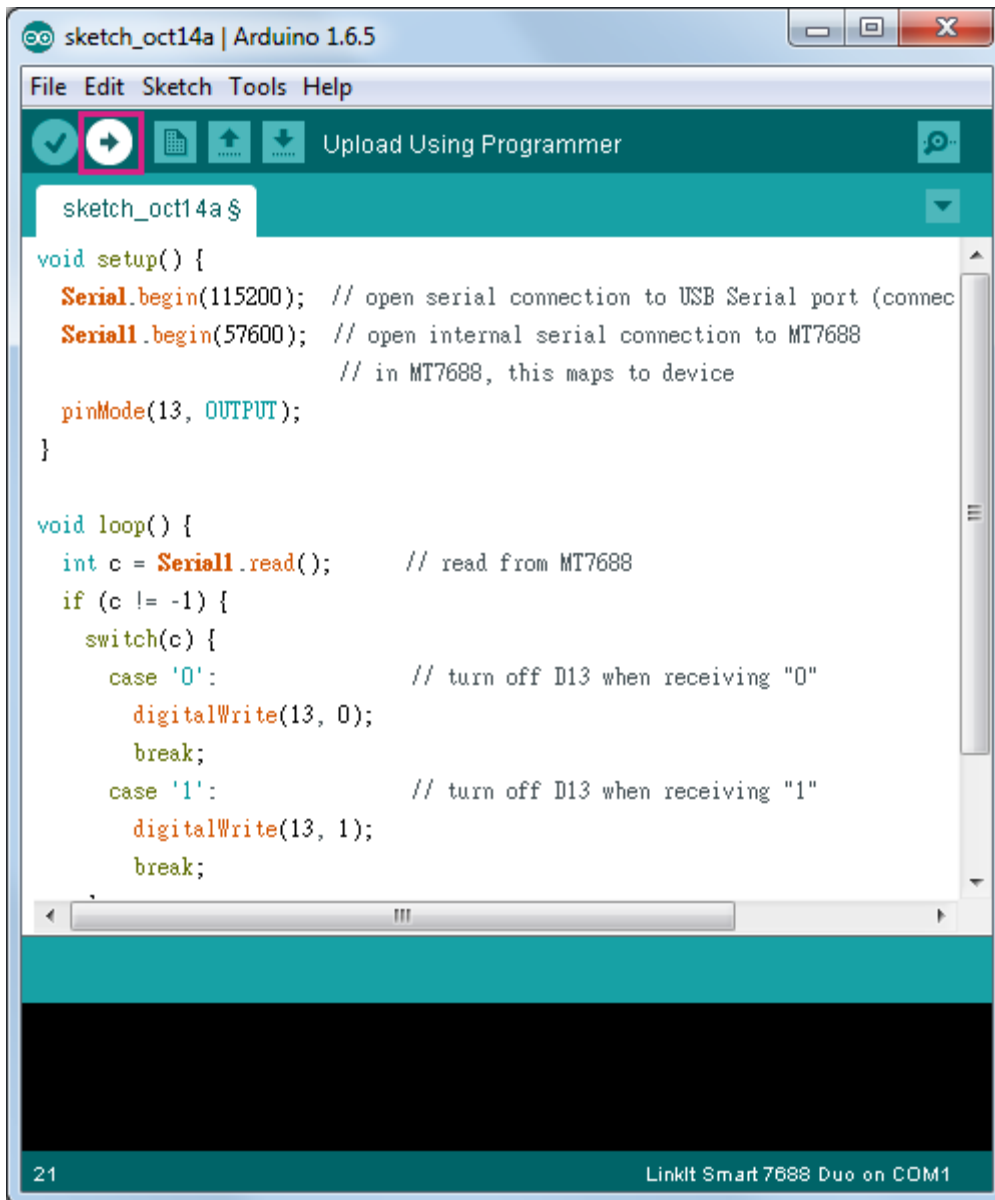

Figure 56 Upload Sketch in Arduino IDE

### 6.5.2. Blink Program – Linux Side

As describe in chapter 3.3, “Programming Model for Different Boards”, you can program the Linux side using many languages, including C/C++, Python or Node.js. In this example, Python is used to illustrate a program that sends command to the MCU (Arduino) side to make the LED blink.

- 1) Use a text editor of your choice and create a new file, then copy the following code and save it.

```
import serial
import time

s = None

def setup():
    global s
    # open serial COM port to /dev/ttyS0, which maps to UART0(D0/D1)
    # the baudrate is set to 57600 and should be the same as the one
    # specified in the Arduino sketch uploaded to ATmega32U4.
    s = serial.Serial("/dev/ttyS0", 57600)

def loop():
    # send "1" to the Arduino sketch on ATmega32U4.
    # the sketch will turn on the LED attached to D13 on the board
    s.write("1")
    time.sleep(1)
    # send "0" to the sketch to turn off the LED
    s.write("0")
    time.sleep(1)

if __name__ == '__main__':
    setup()
    while True:
        loop()
```

- 2) Execute this Python program in the system console – this program basically writes string “1” and “0” to the /dev/ttyS0 port which maps to Serial1 interface in Arduino. The Arduino sketch that was uploaded in the previous section will receive the string and then blink the on-board LED accordingly.

You can now extend the Arduino sketch to drive other devices such as PWM, I2C devices and synchronize the states by extending the command messages between Arduino and the Linux side. If a large amount of peripheral types need to be included, you may want to use some external libraries to implement the communication protocol. One of such protocol – Firmata is described in the following section.

## 6.6. Programming with Firmata Protocol

This section demonstrates how to establish communication between the MPU and the MCU over serial port using Firmata protocol. There are several Firmata implementations using different interfaces such as pyFirmata and PyMata, which is programmed in Python; other languages including Node.js and [cylon.js](#) examples are provided as well in the next sections.

### 6.6.1. Python examples

Two examples are provided in Python in the following sections to demonstrate how to use the Firmata protocol: pyFirmata and PyMata interfaces.

The Serial ports on the microcontrollers are designated as shown in Table 18:

MCU		MPU	
In Arduino	Serial1	In Linux	/dev/ttyS0
Corresponding Pins	D0 and D1	Pin MUX	UART0 (GPIO12 and GPIO13)

**Table 18 Serial Pin Mapping Between MPU and MCU**

### 6.6.2. Prototype

The diagram, as shown in Figure 57, illustrates how the MPU and MCU in LinkIt Smart 7688 Duo communicate with each other using Firmata protocol and Python.

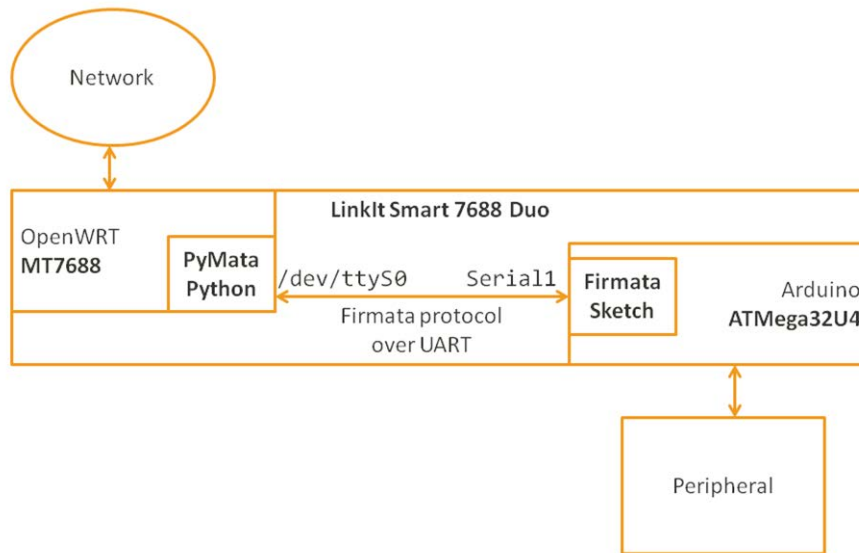

**Figure 57 MPU MCU Communication Diagram**

### 6.6.3. Setup Your Development Environment

LinkIt Smart 7688 Duo supports Arduino 1.6.5 and Python 2.7.

Firmata protocol requires implementation on the MPU and the MCU. To begin, you'll need to install software to program the MCU.

Please make sure you've installed the following:

- **For your PC:**
  - [Arduino IDE 1.6.5](#)  
It provides a set of default implementations and programs the ATmega32U4.

- **For your LinkIt Smart 7688 Duo :**

- Python 2.7

It's preloaded in the system image.

- pyFirmata

This is a Python interface for Firmata protocol used on the MCU. You can install it by typing **pip install pyfirmata** in the system console. At the time of writing, LinkIt Smart 7688 Duo supports version [pyFirmata-1.0.3-py2.7](#).

- PyMata

This is a Python interface for the Firmata protocol used on the MPU. You can install it by typing **pip install PyMata** in the console. At the time of writing, LinkIt Smart 7688 Duo supports version [pymata-2.1](#).



Note: The LinkIt Smart 7688 Duo needs to be in Station mode in order to use **pip** to install the pyFirmata and PyMata interface, please see section 3.4.2, "Station Mode" for details on how to set station mode.

#### 6.6.4. PyFirmata Approach

- **Uploading The Arduino Firmata Sketch**

This section describes setting up Arduino to listen for Firmata commands from the Serial port.

- 1) Open the [Arduino IDE 1.6.5](#)

- 2) In Arduino IDE, open the example File > Examples > Firmata > StandardFirmata

This built-in example is for Arduino Uno, which uses `Serial` as `Serial` port. However, LinkIt Smart 7688 Duo uses `Serial1` to communicate with OpenWrt. Therefore, you'll need to change the listening port of this example from `Serial` to `Serial1`. Find the following line in the example:

```
Firmata.begin(57600);
```

- 3) And change it to:

```
Serial1.begin(57600);
Firmata.begin(Serial1);
```

- 4) Upload the sketch. After uploading the sketch, Arduino is ready to receive commands from the Linux side.

- **Running Your Blink Example Using pyFirmata**

After pyFirmata is installed, you're ready to run a blink example.

- 1) In the console, create a python file called `blink_with_firmata.py`

- 2) Open the file and copy and paste the following example code. This [example](#) code is modified to work for LinkIt Smart 7688 Duo. For example:

```
from pyfirmata import Arduino, util
from time import sleep

board = Arduino('/dev/ttyS0')
print "Start blinking D13"
while True:

    board.digital[13].write(1)
    sleep(0.5)

    board.digital[13].write(0)
    sleep(0.5)
```

- 3) Now execute this Python script and you should see following message:

```
# python ./blink_with_firmata.py
Start blinking D13
```

If you see the LED on D13 of the LinkIt Smart 7688 Duo blink accordingly, congratulations. You've successfully ran the blink example.

To terminate the Python program, press **Ctrl-C**.

### 6.6.5. PyMata Approach

- **Uploading the Arduino PyMata Sketch**

PyMata is a Python interface for the Firmata protocol and it uses its own Firmata sketch. Therefore you need to install the PyMata libraries before you start uploading the sketch to Arduino.

Please make sure you've the following:

- 1) Download [PyMata](#) libraries (PyMata-master.zip) to Arduino library folder on your computer and extract it.
- 2) In the extracted folder, open the folder ArduinoSketch and you should see the library.zip file.
- 3) Extract the content of the library.zip file.
- 4) Copy the extracted content of the library.zip file to your Arduino Library folder C:\Program Files (x86)\Arduino\libraries\

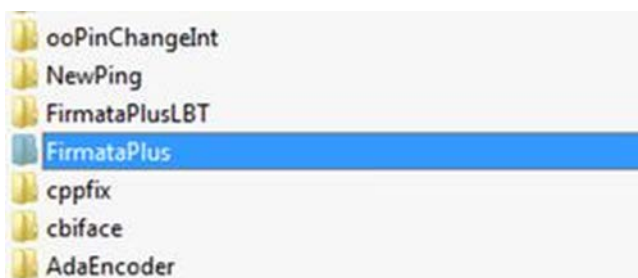

- **Using FirmataPlus Example**

Now you're ready to set up Arduino to listen for Firmata commands from the Serial port.

- 1) Open the Arduino IDE 1.6.4 or 1.6.5
- 2) In Arduino IDE, open the example File > Examples > FirmataPlus > FirmataPlus

This built-in example is for Arduino Uno, which uses `Serial` as Serial port. However, LinkIt Smart 7688 Duo uses `Serial1` to communicate with OpenWrt. Therefore, you'll need to change the listening port of this example from `Serial` to `Serial1`. Find the following line in the example:

```
Firmata.begin(57600);
```

- 3) And change it to

```
Serial1.begin(57600);  
Firmata.begin(Serial1);
```

- 4) Upload the sketch. After uploading the sketch, Arduino is ready to receive commands from the Linux side.

- **Running Blink Example Using PyMata**

After you've installed PyMata libraries and changed the serial port in Arduino, you're ready to run the blink example using PyMata.

- 1) Download [blink example](#) to LinkIt Smart 7688 Duo.

You'll also need to change the serial port used in this example to work on LinkIt Smart 7688 Duo. Find the following line on the example:

```
# Create a PyMata instance  
board = PyMata("/dev/ttyACM0", verbose=True)
```

- 2) And change it to:

```
# Create a PyMata instance  
board = PyMata("/dev/ttyS0", verbose=True)
```

3) Execute the python script and you should see following output:

```
# python ./pymata_blink.py
Python Version 2.7.9 (default, Aug 12 2015, 15:09:09)
[GCC 4.8.3]

PyMata version 2.10 Copyright(C) 2013-15 Alan Yorinks All rights
reserved.

Opening Arduino Serial port /dev/ttyS0

Please wait while Arduino is being detected. This can take up to 30 seconds
...
Board initialized in 0 seconds
Total Number of Pins Detected = 30
Total Number of Analog Pins Detected = 12
Blinking LED on pin 13 for 10 times ...
 1
 2
 3
 4
 5
 6
 7
 8
 9
10
PyMata close(): Calling sys.exit(0): Hope to see you soon!
```

If you see the LED on D13 of the LinkIt Smart 7688 Duo blink 10 times before the Python program terminates, congratulations. You've successfully ran the blink example.

Please continue to explore more examples in the PyMata/examples you've downloaded earlier. Just remember to change the serial port to /dev/ttyS0, and keep in mind the hardware differences between LinkIt Smart 7688 Duo and Arduino Uno:

- LinkIt Smart 7688 Duo operates in 3.3V, not 5V as in Arduino Uno.
- You'll need extra power source when driving motor or servo peripherals because they draw more current.

Please refer to [Firmata website](#) for other Python interfaces available to Firmata protocol.

### 6.6.6. Node.js example

This section illustrates the MPU and MCU communication using Firmata protocol in Node.js. The main steps are:

- 1) Set up the MCU, start by Launching Arduino IDE 1.6.5 on your computer



- Copy the Firmata example to Arduino, you do this by opening a browser and click [here](#). You'll see a Firmata example code. Click on **Raw** button to copy the code, as shown in Figure 58 below.

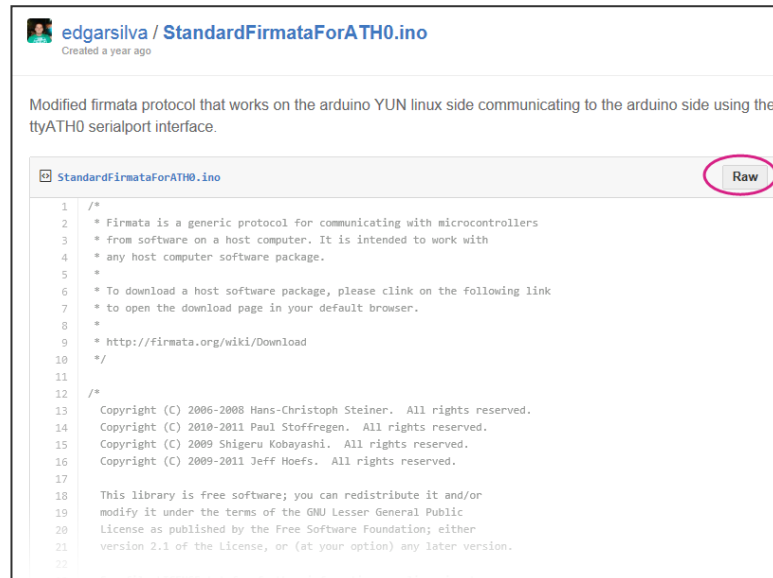

Figure 58 Copying example code from Github

- Copy the example code to the Arduino IDE and click **Upload**, as shown in Figure 59.

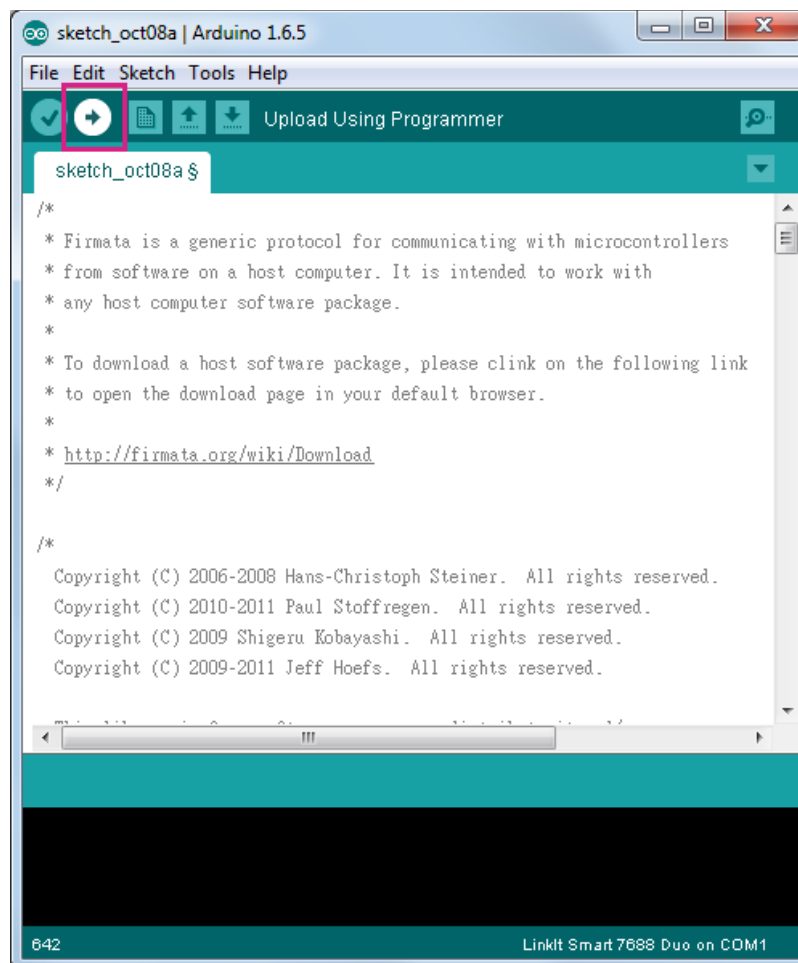

Figure 59 Uploading example sketch in Arduino IDE

- 4) Set up the MPU, for this you'll need to install Firmata on your computer. While you can install Firmata using NPM on LinkIt Smart 7688 Duo, the process is a bit long, that's why you should install [NPM](#) on your computer instead and do the Firmata installation from there. In your host computer, create a folder called `testfirmata` and switch to the directory. The `$` indicates command prompt and is not part of the command.

```
$ mkdir testfirmata && cd testfirmata
```

- 5) After you've installed NPM, use it to initialize the file. For example:

```
$ npm init
```

- 6) Install Firmata by typing the following command.

```
$ npm install firmata --save
```

- 7) Remove node-serial port by typing the following command.

```
$ rm -rf ./node_modules/firmata/node_modules/serialport
```



Firmata has a built in node-serial port and when you installed Firmata, it creates a compile file on your computer. However, this compile file needs to be removed because it's already built in LinkIt Smart 7688 Duo.

- 8) Compress the Firmata folder

```
$ tar -cvf ./firmata.tar ./node_modules/firmata
```

- 9) Use scp to transfer the compressed file to LinkIt Smart 7688 Duo

```
$ scp ./firmata.tar root@mylinkit.local:/root/app/node_modules
```

- 10) Open the LinkIt Smart 7688 Duo SSH system console and type the following commands to create a directory called `app` and go to that directory.

```
# mkdir app && cd app
```

- 11) Create a file called `app.js`

```
# vim app.js
```

12) Type **i** to insert the following example code:

```

console.log('WWW blink start ...');

var ledPin = 13;
var firmata = require('firmata');

var board = new firmata.Board("/dev/ttyS0",function(err) {
  if (err) {
    console.log(err);
    board.reset();
  }
  return;
});

console.log('connected...');
console.log('board.firmware: ', board.firmware);

board.pinMode(ledPin, board.MODES.OUTPUT);

var url = require('url');
var http = require('http');

    http.createServer(function(request, response) {
        var params = url.parse(request.url, true).query;

        if (params.value.toLowerCase() == 'high') {
            board.digitalWrite(ledPin, board.HIGH);
        } else {
            board.digitalWrite(ledPin, board.LOW);
        }
        response.writeHead(200);
        response.write("The value written was: " + params.value);
        response.end();
    }).bind(this)).listen(8080);

    console.log('Listening on port 8080 ...');
});
    
```

13) Type **Esc** key and **:wq!** to save and exit the editor.

14) Run the Node.js example by typing the following command in the system console:

```
# node app
```

15) Open a browser and enter the following commands to control the LED:

- a) To turn LED ON: `mylinkit.local:8080?value=high`
- b) To turn LED OFF: `mylinkit.local:8080?value=low`

16) The D13 LED on LinkIt Smart 7688 Duo should blink according to your command of choice.

### 6.6.7. Cylon.js example

This section illustrates the MPU and MCU communication using Firmata in Cylon.js programming language. The steps are:

- 1) Set up the MCU, start by launching Arduino IDE 1.6.5 on your computer.
- 2) Copy the Firmata example, you do this by opening a browser and click [here](#). You'll see a Firmata example code. Click on **Raw** button to copy the code, similar to Figure 58.
- 3) Set up the MPU, for this you'll need to install Firmata and four Cylon modules (`cylon`, `cylon-firmata`, `cylon-gpio` and `cylon-i2c`) on your computer. The Cylon modules are needed to communicate with the hardware attached to Arduino. While you can install Firmata and Cylon using NPM on LinkIt Smart 7688 Duo, the process is a bit long, that's why you should install [NPM](#) on your computer instead and install Firmata and the Cylon modules from there. The steps to install Firmata are already described in section 6.6.6, "Node.js example" and it's the same for Cylon. Therefore, only Cylon example is used below. Create a folder called `testcylon` and switch to the directory. The `$` indicates command prompt and is not part of the command.

```
$ mkdir testcylon && cd testcylon
```

- 4) After you've installed NPM, use it to initialize the file. For example:

```
$ npm init
```

- 5) Install four Cylon on your computer by typing the following command.

```
$ npm install cylon --save
$ npm install cylon-firmata --save
$ npm install cylon-gpio --save
$ npm install cylon-i2c --save
```

- 6) Remove node-serial port by typing the following command.

```
$ rm -rf ./node_modules/cylon/node_modules/serialport
$ rm -rf ./node_modules/cylon-firmata/node_modules/serialport
$ rm -rf ./node_modules/cylon-gpio/node_modules/serialport
$ rm -rf ./node_modules/cylon-i2c/node_modules/serialport
```



Cylon has a built in node-serial port and when you installed Cylon, it creates a compile file on your computer. However, this compile file needs to be removed because it's already built in LinkIt Smart 7688 Duo.

- 7) Compress the Cylon folder

```
$ tar -cvf ./cylon.tar ./node_modules/cylon
```

8) Use scp to transfer the compressed file to LinkIt Smart 7688 Duo

```
$ scp ./cylon.tar root@mylinkit.local:/root/app/node_modules
```

9) Set up the MPU, start by opening the SSH console and create a folder app, # is the console prompt and is not part of the command.

```
# mkdir app && cd app
```

10) Create a file app.js and open text editor by typing:

```
# vim app.js
```

11) Press i and copy the following example in the text editor:

```
var Cylon = require('cylon');

Cylon.robot({
  connections: {
    arduino: { adaptor: 'firmata', port: '/dev/ttyS0' }
  },
  devices: {
    led: { driver: 'led', pin: 13 }
  },

  work: function(my) {
    every((1).second(), my.led.toggle);
  }
}).start();
```

12) Save and exit the editor by typing **Esc** key and **:wq!**

13) Execute the Cylon.js program by typing the following command:

```
# node app.js
```

14) The D13 LED on LinkIt Smart 7688 Duo should blink every second.

## 6.6.8. Updating the ATmega32U4 Bootloader

This chapter explains the methods you can use to program the bootloader on the ATmega32U4. LinkIt Smart 7688 Duo is pre-programmed with Arduino bootloader in the microcontroller (ATmega32U4). You are not required to program the bootloader, but in the event the bootloader is damaged or requires re-programming, you can use one of the following methods to update the bootloader.

### 6.6.9. Using LinkIt Smart 7688 Duo to program bootloader on another LinkIt Smart 7688 Duo

In the following example, there are two LinkIt Smart 7688 Duo boards called A and B. The first board A will act as the programmer to program the second board B.

- 1) In Arduino IDE, go to **Tools > Board >** and select **LinkIt Smart 7688 Duo**
- 2) Open the sketch **Example > ArduinoISP**
- 3) Modify the code line `#define RESET SS` to `#define RESET 10`
- 4) Upload the modified sketch to board A
- 5) Connect pins S0, S1, S2, GND of board A to the same pins of board B
- 6) Connect pin D10 of board A to pin RST of board B
- 7) In Arduino IDE, go to **Tools > Programmer >** and select **LinkIt Smart 7688 Duo as ISP**
- 8) Finally, go to **Tools >** and select **Burn Bootloader**

#### 6.6.9.1. Using AVRDUDE from OpenWrt to Program Bootloader

You can also program ATmega32U4 from the Linux side (MT7688AN). The system image is preloaded with AVRDUDE package that allows you to program the ATmega32U4. AVRDUDE is a command line tool for flashing codes to MCU on Linux.

- 1) Copy the bootloader file to a storage device (USB drive or SD card) or to your computer. The bootloader file is located in the following path:

```
{ARDUINO_IDE_PREFERENCE_LOCATION}\Arduino15\packages\LinkIt\hardware\avr\0.1.5\bootloaders\caterina\Caterina-smart7688.hex
```

Please see Figure 50 for Arduino preference location.

- 2) Transfer the bootloader to LinkIt Smart 7688 Duo. You can use a storage device or SCP tool to transfer the bootloader. In this example, a USB drive called USB-A1 is used. Connect the USB drive to LinkIt Smart 7688 Duo and in the system console, go to the root directory by typing the following command:

```
# cd /Media/USB-A1
```

- 3) In the system console, execute the following command:

```
# avrdude -p m32u4 -c linuxgpio -v -e -U flash:w:Caterina-smart7688.hex -U lock:w:0x0f:m
```

- 4) After the bootloader is programmed into the ATmega32U4, you should see a screen similar to Figure 60.

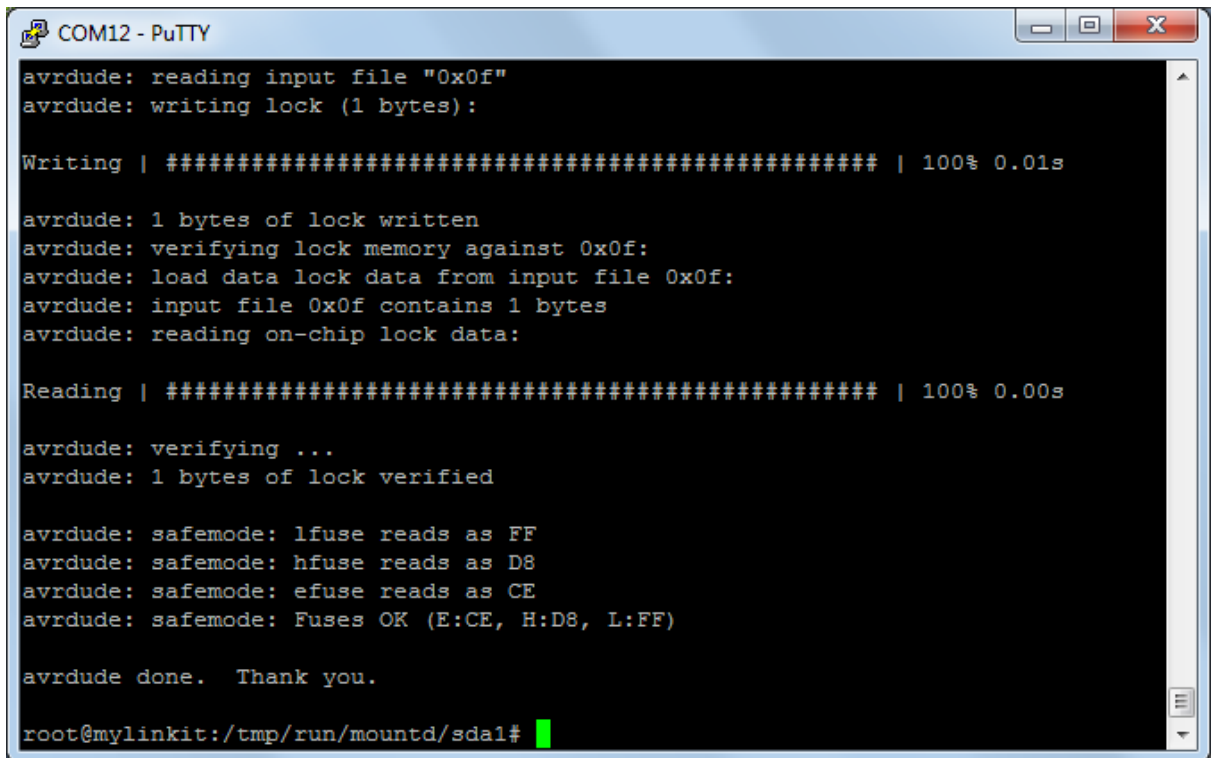

Figure 60 Programming bootloader using AVRDUDE

- 5) Please refer to AVRDUDE package for detailed information.

## 6.7. Programming with Yun Bridge Library

LinkIt Smart 7688 Duo can also facilitate the [Yun Bridge library](#) to a certain degree. To make the Bridge library work, you'll need to configure the system to allow various Bridge related services to run. You'll also need to set the system console to map to /dev/ttyS0 which allows the Arduino side to issue commands to the Linux system. Luckily, the default system image of LinkIt Smart 7688 Duo wraps all the aforementioned configurations into a single UCI configuration. All you need to do is to enable it. You can do this by typing the following command in the system console and reboot the system. For example:

```

# uci set yunbridge.config.disabled='0'
# uci commit
# reboot
    
```

After reboot finishes, the system is ready to accept commands from the Arduino side. Connect the board to you computer and open Arduino IDE, then choose **File > Examples > Bridge > TimeCheck**. Next, upload the TimeCheck example sketch to LinkIt Smart 7688 Duo and launch the Serial Monitor. You should see following outputs from the Serial Monitor.

```

Time Check
00:00:00
03:42:05
03:42:06
    
```

The output time stamp should be the same as the Linux system time stamp.

You can also try other examples of the Bridge library. Note that some scripts and services may act differently on the default system image, so you may need to modify the sketch files accordingly.

Please also note that while the system is configured to work with the Bridge library, the `/dev/ttyS0` becomes occupied by the Bridge library and it is not advised to try accessing it when in use. For example, Firmata won't work when the system is configured to support Bridge library.

To stop the system from launching Bridge related services and occupying `/dev/ttyS0`, use following commands in system console and reboot the system:

```
# uci set yunbridge.config.disabled='1'  
# uci commit  
# reboot
```



## 7. How to Build Firmware and Bootloader

---

This chapter explains how to build firmware and bootloader for the LinkIt Smart 7688/7688Duo development platform.

### 7.1. Building a firmware

The LinkIt Smart 7688/7688 Duo development platform supports Makefile-based builds, which allows you to build firmware with the `make` command.

Instructions in this section apply for an Ubuntu Linux 14.04.3 environment.

- 1) The first step is to install virtual machine if your host environment isn't Ubuntu. The disk space you should reserve is about 50GB
  - o Get the Ubuntu 14.04.3 LTS from <http://www.ubuntu.com>
  - o Install Virtual Box from <http://virtualbox.org>
- 2) Building a firmware requires installing prerequisite packages. Open Terminal and type the following command:

```
$ sudo apt-get install git g++ libncurses5-dev subversion libssl-dev gawk  
libxml-parser-perl unzip
```

- 3) Download the OpenWrt CC source code; it includes the full OpenWrt environment to build the firmware (including the Linux kernel). Type the following command to download the source code:

```
$ git clone git://git.openwrt.org/15.05/openwrt.git
```

- 4) Create a configuration file `feeds.conf` by copying from the default template file `feeds.conf.default`

```
$ cd openwrt  
$ cp feeds.conf.default feeds.conf
```

- 5) Add the LinkIt Smart 7688 feed to `feeds.conf`

```
$ echo src-git linkit https://github.com/MediaTek-Labs/linkit-smart-7688-  
feed.git >> feeds.conf
```

- 6) Update the feed information for all packages needed to build firmware

```
$ ./scripts/feeds update
```

- 7) Install all packages

```
$ ./scripts/feeds install -a
```

- 8) Prepare the kernel configuration file for informing OpenWrt the intention to build a firmware for LinkIt Smart 7688

```
$ make menuconfig
```

- 9) Select options to set target profile per below:
  - Target System: Ralink RT288x/RT3xxx
  - Subtarget: MT7688 based boards
  - Target Profile: LinkIt 7688
- 10) Save the options and exit (use the default config file name without changing it)
- 11) Start the firmware compilation process with make

```
$ make V=99
```

- 12) After the compilation process completes, the resulting firmware file will be under `bin/ramips/openwrt-ramips-mt7688-LinkIt7688-squashfs-sysupgrade.bin`
- 13) Now you can use this file to do the firmware upgrade through Web UI or rename it to `lks7688.img` and use it to upgrade firmware through a USB drive.

## 7.2. Building a bootloader

The LinkIt Smart 7688/7688 Duo development platform supports Makefile-based builds, which allows you to build bootloader with the `make` command.

The instructions in this section apply for an Ubuntu Linux 14.04.3 environment.

- 1) Please refer to section 7.1, "Building a firmware" for preparing the environment for building bootloader.
- 2) Download the bootloader source code by typing the following command:

```
$ git clone https://github.com/MediaTek-Labs/linkit-smart-uboot.git
```

- 3) Change to the LinkIt Smart 7688 bootloader source code folder

```
$ cd linkit-smart-uboot
```

- 4) Install the tool-chain needed for building bootloader, this tool-chain is provided in 32-bit executable

```
$ sudo tar xjf buildroot-gcc342.tar.bz2 -C /opt/
```

- 5) Install additional packages to execute the tool-chain in a 64-bit machine

```
$ sudo dpkg --add-architecture i386
$ sudo apt-get update
$ sudo apt-get install libc6:i386 libncurses5:i386 libstdc++6:i386
```

- 6) Start the bootloader compilation process

```
$ make
```

- 7) After the compilation process finishes, the resulting bootloader file is `uboot.bin`
- 8) Now you can rename this file to `lks7688.ldr` and use it to upgrade bootloader through a USB drive.

(The remainder of this page is intentionally left blank)

## 8. Troubleshooting Guide

---

### 8.1. My firmware upgrade won't start or failed. Why?

If you're using a USB drive to upgrade firmware, please make sure you've checked the following:

- The USB host cable that connects to the USB drive is firmly attached
- The USB power/host cable is securely attached to the Power connector and not the Host connector of the board.

If you're using the Web UI to upgrade firmware, please make sure you've checked the following:

- The power source is steadily supplied to LinkIt Smart 7688/7688 Duo during firmware upgrade. Do not unplug the USB drive or disconnect the USB cable during firmware upgrade process or else your board will fail to boot up. If that happens, you can use bootloader to boot up the device and perform the firmware upgrade process. Please see section 4.6.2, "Upgrading bootloader" for more information.

After you've checked the items above, please try again, if you still can't upgrade the firmware, please contact technical support at Seeed Studios or go to MediaTek Labs forum.

### 8.2. I can't connect to URL mylinkit.local using a browser, why is that?

If you're using Windows 7, please install [Bonjour print service](#) (32 or 64 bits), restart your computer and try **mylinkit.local** on your browser again. Please make sure your PC is within the same local network as LinkIt Smart 7688.

### 8.3. My virtual machine cannot detect the board with mylinkit.local, why?

In a simulated Linux environment such as virtual machine, mDNS isn't supported and therefore you need to have the IP address of the board in order for it to be identified. To find the IP address of the board, type **ifconfig** in the system console. The IP address should show in the first paragraph under **apcli0**, as shown in Figure 61. You can also ping mylinkit.local in the host PC to get the IP address when your PC and the board are under the same local network.

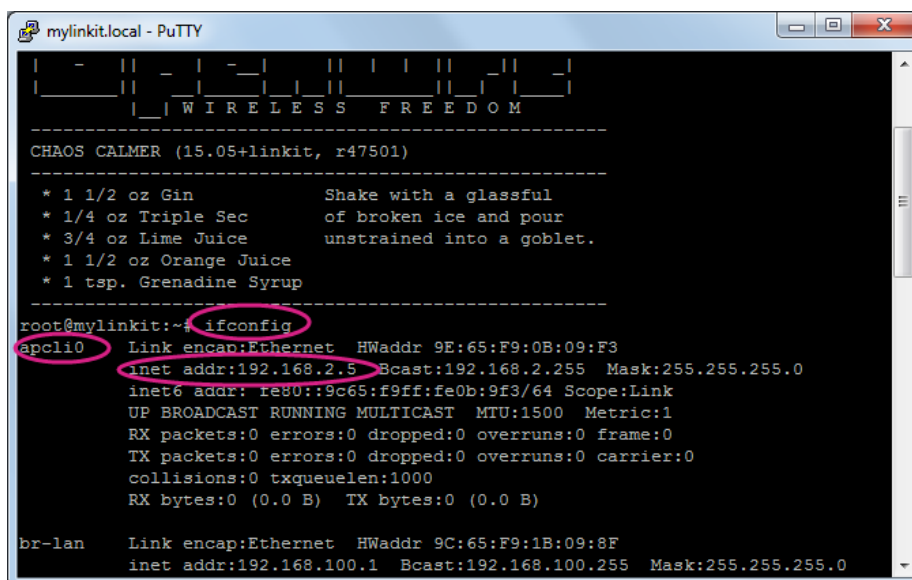

Figure 61 Finding LinkIt Smart 7688 IP address in Station mode

### 8.4. I'm not able to SSH access with an error showing "Host Identification Has Changed", what can I do?

If you see an error message similar to below as shown in Figure 62:

```

@@@@@@@@@@@@@@@@@@@@@@@@@@@@@@@@@@@@@@@@@@@@@@@@@@@@@@@@@@@@@@@@@@@@@@@@@@@@@@@@
@  WARNING: REMOTE HOST IDENTIFICATION HAS CHANGED!  @
@@@@@@@@@@@@@@@@@@@@@@@@@@@@@@@@@@@@@@@@@@@@@@@@@@@@@@@@@@@@@@@@@@@@@@@@@@@@@@@@
IT IS POSSIBLE THAT SOMEONE IS DOING SOMETHING NASTY!
Someone could be eavesdropping on you right now (man-in-the-middle attack)!
It is also possible that a host key has just been changed.
The fingerprint for the RSA key sent by the remote host is
5b:34:59:6b:f3:f5:c1:a9:e6:f9:0d:5a:63:2c:4c:21.
Please contact your system administrator.
Add correct host key in /Users/_____/ssh/known_hosts to get rid of this mess
age.
Offending RSA key in /Users/_____/ssh/known_hosts:1
RSA host key for mylinkit.local has changed and you have requested strict checki
ng.
Host key verification failed.
    
```

Figure 62 Host ID change warning

It indicates you've used a different LinkIt Smart 7688 board or upgraded a new firmware and tried to access system console using SSH. The new firmware or different board creates a new host identification which is different from the previous one, hence the error. To fix this issue, you need to remove the old host ID. Here's how:

- 1) In your Terminal, open the known hosts file. This example uses **vi** editor, but you can use any editor you prefer. # is the terminal command prompt and is not part of the command.

```
# vi ~/.ssh/known_hosts
```

- 2) Find the line or move the cursor to where `mylinkit.local` is located, as shown below in Figure 63.

```
IEArDzVUTEjNdKnMd06iLUqzd2TjZJuC+qGbMRbs2VvmPslr0yLLd/xyTtkYDqFC2rv+Mps5rCrtmLMS
iKF6KxqXSI0y7likJm6QUrVEtoBkrSoC4oRzpsHPAn0MDCn080X+WQ8uGwR5kX5wS03vBNaiYKLLerVV
MngasPN0Zp3dnE=
mylinkit.local,192.168.100.1 ssh-rsa AAAAB3NzaC1yc2EAAAADAQABAAQAC/cSjMtsjCgIy
/kkDKZeJ4pjdI46ZgCb49Xwj+TF8W1zTnnBsuTDHaJrUUBqgonxeKYg4FL2cvhsw8ogNgM0IvDZt35b2
EdQSNgqjYjMd1qbcDint+jyovwKRA5RXr/3WwhxL0Wzzn0+Ih+lrgkghWI6HTnNXUF+mEHyZHKTVXa29
TA3Nihj9zhMrNjBigL0Du5sYL/ddWfRMP5FLVKN1s0y/lz5WF3WHv5kl16GHFQy3gVJmV5llbwTaUPSI
P59qQjdxs7bpK/9Wkcrt4rebGTysSJT8hjIT11cJSaImcuR64/kheFFz50LuSxtlU+HESLIInI3Fecqb
Iips3LuFV
```

*Figure 63 Known hosts file*

- 3) Type **dd** (the vi command) to delete this entry.
- 4) Save and exit the editor by typing **Esc** key and **:wq!** (the vi command)
- 5) Now try ssh [root@mylinkit.local](ssh://root@mylinkit.local) again and you should be able to access system console.

## 8.5. There are multiple LinkIt Smart 7688 APs nearby and I'm not sure which one is mine, how do I find out?

To find the hardware address of the board, type **ifconfig** in the system console. The hardware address should show in the first sentence under **ra0**, as shown in Figure 64. The last three set of numbers should match your board's AP name.

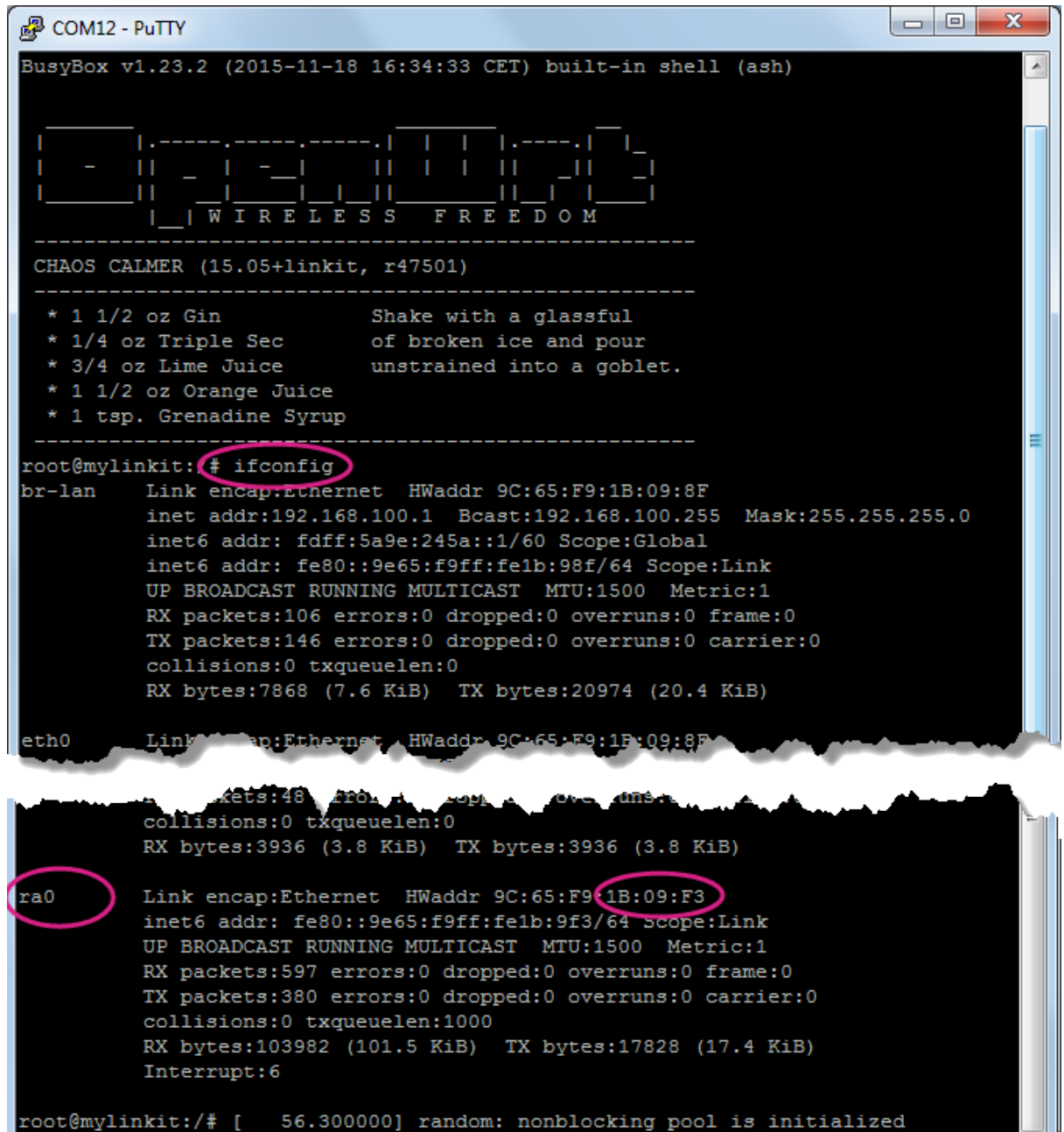

Figure 64 Finding LinkIt Smart 7688 hardware address

## 8.6. My onboard flash is very slow and seems broken, why?

The SPI NOR flash has limited write cycles (about 100,000 times) and the file system operation is not atomic. So, if the flash writes back too frequently or has been exposed to power cut during file

write-back operation, the flash may be damaged as a result. Therefore, it's recommended to use the temp file system (/tmp) or write to external storages such as USB drive or SD card for data I/O.

## 8.7. Why did my board failed to start up due to corrupted file system?

It could be that the onboard flash is damaged from the same problem as 8.6.

## 8.8. What can I do if my onboard flash is full?

You can use external storage device for more data storage or extend the root file system onto the external storage devices.

## 8.9. Why is my I2C device not working?

MT7688AN doesn't provide I2C clock stretching and repeated start functions.

## 8.10. Why does my board keep rebooting when driving a servo?

Please connect the servo with an external power source instead of using VOUT on LinkIt Smart 7688 to avoid dealing with board insufficient power.

(The remainder of this page is intentionally left blank)



## Appendix A Federal Communication Commission Interference Statement

---

This device complies with Part 15 of the FCC Rules. Operation is subject to the following two conditions: (1) This device may not cause harmful interference, and (2) this device must accept any interference received, including interference that may cause undesired operation.

This equipment has been tested and found to comply with the limits for a Class B digital device, pursuant to Part 15 of the FCC Rules. These limits are designed to provide reasonable protection against harmful interference in a residential installation. This equipment generates, uses and can radiate radio frequency energy and, if not installed and used in accordance with the instructions, may cause harmful interference to radio communications. However, there is no guarantee that interference will not occur in a particular installation. If this equipment does cause harmful interference to radio or television reception, which can be determined by turning the equipment off and on, the user is encouraged to try to correct the interference by one of the following measures:

- Reorient or relocate the receiving antenna.
- Increase the separation between the equipment and receiver.
- Connect the equipment into an outlet on a circuit different from that to which the receiver is connected.
- Consult the dealer or an experienced radio/TV technician for help.

### FCC Caution:

- Any changes or modifications not expressly approved by the party responsible for compliance could void the user's authority to operate this equipment.
- This transmitter must not be co-located or operating in conjunction with any other antenna or transmitter.

### Radiation Exposure Statement:

This equipment complies with FCC radiation exposure limits set forth for an uncontrolled environment. This equipment should be installed and operated with minimum distance 20cm between the radiator & your body.

### This device is intended only for OEM integrators under the following conditions:

- 1) The antenna must be installed such that 20 cm is maintained between the antenna and users, and the maximum antenna gain allowed for use with this device is **0.31** dBi.
- 2) The transmitter module may not be co-located with any other transmitter or antenna.

As long as 2 conditions above are met, further transmitter test will not be required. However, the OEM integrator is still responsible for testing their end-product for any additional compliance requirements required with this module installed

**IMPORTANT NOTE:** In the event that these conditions can not be met (for example certain laptop configurations or co-location with another transmitter), then the FCC authorization is no longer considered valid and the FCC ID can not be used on the final product. In these circumstances, the OEM integrator will be responsible for re-evaluating the end product (including the transmitter) and obtaining a separate FCC authorization.

### End Product Labeling I:

This transmitter module is authorized only for use in device where the antenna may be installed such that 20 cm may be maintained between the antenna and users. The final end product must be labeled in a visible area with the following: “**Contains FCC ID: Z4T-LINKITS7688**”. The grantee's FCC ID can be used only when all FCC compliance requirements are met.

**End Product Labeling II:**

This transmitter module is authorized only for use in device where the antenna may be installed such that 20 cm may be maintained between the antenna and users. The final end product must be labeled in a visible area with the following: “**Contains FCC ID: Z4T-LINKITS7688D**”. The grantee's FCC ID can be used only when all FCC compliance requirements are met.

**Manual Information To the End User**

The OEM integrator has to be aware not to provide information to the end user regarding how to install or remove this RF module in the user's manual of the end product which integrates this module. The end user manual shall include all required regulatory information/warning as show in this manual.

(The remainder of this page is intentionally left blank)