

LM3909



## LM3909 LED Flasher/Oscillator

### General Description

The LM3909 is a monolithic oscillator specifically designed to flash Light Emitting Diodes. By using the timing capacitor for voltage boost, it delivers pulses of 2 or more volts to the LED while operating on a supply of 1.5V or less. The circuit is inherently self-starting, and requires addition of only a battery and capacitor to function as an LED flasher.

Packaged in an 8-lead plastic mini-DIP, the LM3909 will operate over the extended consumer temperature range of -25°C to + 70°C. It has been optimized for low power drain and operation from weak batteries so that continuous operation life exceeds that expected from battery rating.

Application is made simple by inclusion of internal timing resistors and an internal LED current limit resistor. As shown in the first two application circuits, the timing resistors supplied are optimized for nominal flashing rates and minimum power drain at 1.5V and 3V. Timing capacitors will generally be of the electrolytic type, and a small 3V rated part will be suitable for any LED flasher using a supply up to 6V. However, when picking flash rates, it should be remembered that some electrolytics have very broad capacitance tolerances, for example -20% to + 100%.

### Features

- Operation over one year from one C size flashlight cell
- Bright, high current LED pulse
- Minimum external parts
- Low cost
- Low voltage operation, from just over 1V to 5V
- Low current drain, averages under 0.5 mA during battery life
- Powerful; as an oscillator directly drives an 8?? speaker
- Wide temperature range

### Applications

- Finding flashlights in the dark, or locating boat mooring floats
- Sales and advertising gimmicks
- Emergency locators, for instance on the extinguishers
- Toys and novelties
- Electronic applications such as trigger and sawtooth generators
- Siren for toy fire engine, (combined oscillator, speaker driver)
- Warning indicators powered by 1.4V to 200V

### Schematic Diagram

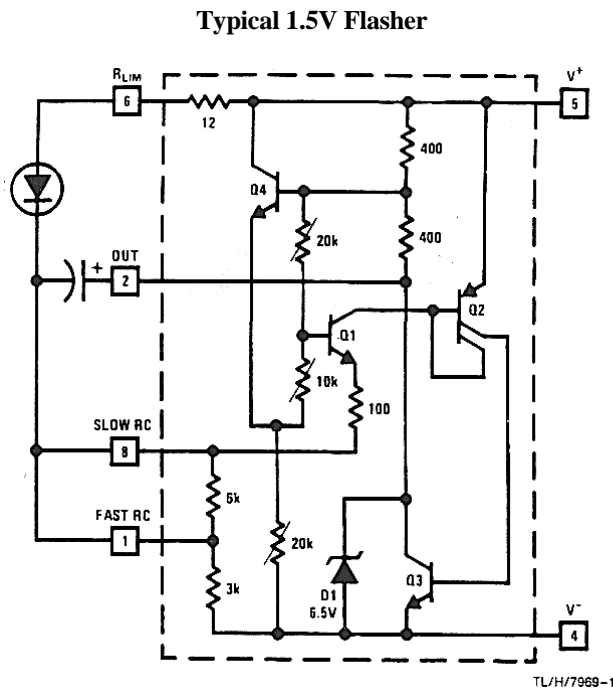

### Connection Diagram

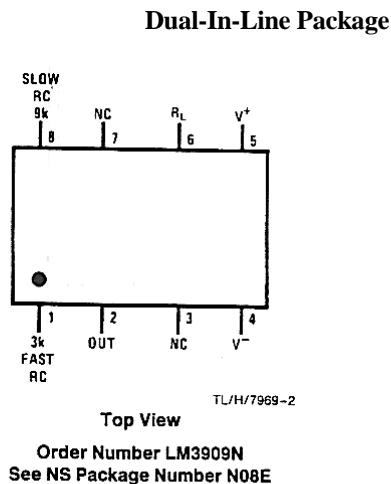

Jameco Part number 24192

**Absolute Maximum Ratings**

If Military/Aerospace specified devices are required, contact the National Semiconductor Sales Office/Distributors for availability and specifications.  
 Power Dissipation 500 mW  
 V+ Voltage 6.4V

Operating Temperature Range -25°C to +70°C  
 Lead Temperature (Soldering, 10 sec.) 260°C

**LM3909**

**Electrical Characteristics**

Parameter	Conditions	Min	Typ	Max	Units
	(Applications Note 3)				
Supply Voltage	(In Oscillation)	1.15		6.0	V
Operating Current			0.55	0.75	mA
Flash Frequency	300 $\mu$ F, 5% Capacitor	0.65	1.0	1.3	Hz
High Flash Frequency	0.30 $\mu$ F, 5% Capacitor		1.1		kHz
Compatible LED Forward Drop	1 mA Forward Current	1.35		2.1	V
Peak LED Current	350 $\mu$ F Capacitor		45		mA
Pulse Width	350 $\mu$ F Capacitors at 1/2 Amplitude		6.0		ms

Typical Applications (See applications notes on following page)

**Triac Trigger**

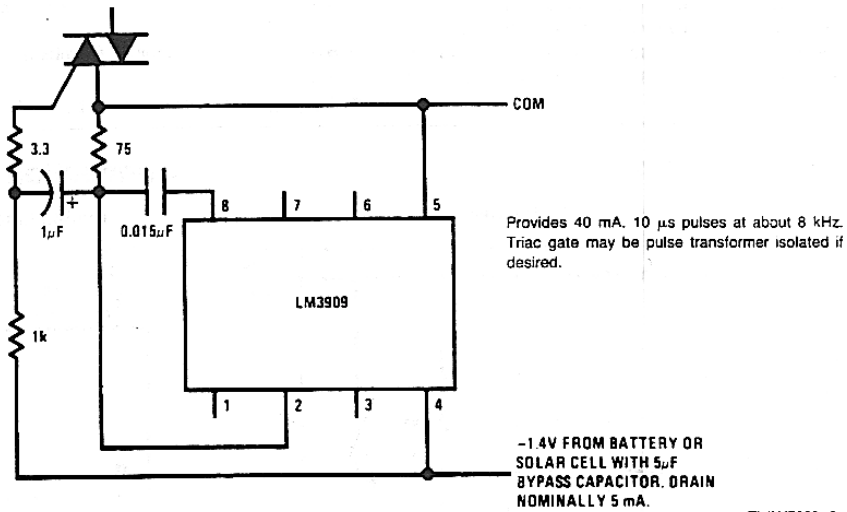

TL/H/7969-3

**5**

**LM3909**

Jameco Part number 24192

**Typical Applications** (Continued)(See applications notes below)

**Warning Flasher High Voltage Powered**

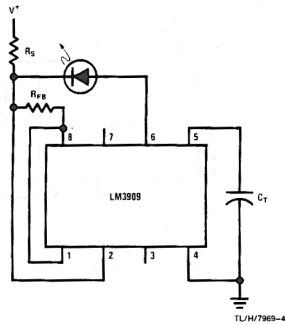

**Typical Operating Conditions**

V+	Nominal Flash Hz	CT	RS	RFB	V+RANG E
6V	2	400 μF	1k	1.5k	5V-25V
15V	2	180 μF	3.9k	1k	13V-50V
100 V	1.7	180 μF	43k	1k	85V-200V
			1W		

**1.5V Flasher**

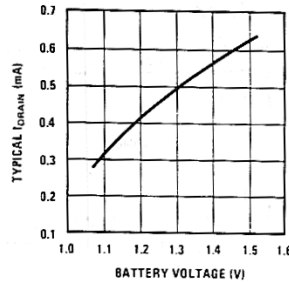
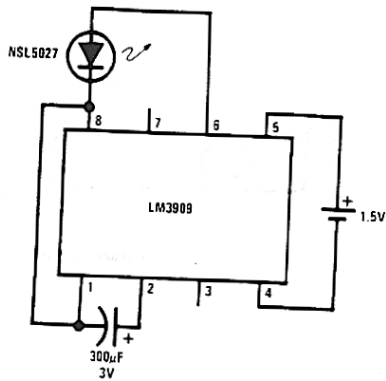

**Estimated Battery Life (Continuous 1.5V Flasher Operation)**

Size Cell	Type	
	Standard	Alkaline
AA	3 months	6 months
C	7 months	15 months
D	1.3 years	2.6 years

**Note:** Nominal flash rate: 1 Hz.

**Note:** Estimates are made from our tests and manufacturers data. Conditions are fresh batteries and room temperature. Clad or "leak-proof" batteries are recommended for any application of five months or more. Nickel Cadmium cells are not recommended.

**APPLICATIONS NOTES**

**Note 1:** All capacitors shown are electrolytic unless marked otherwise.

**Note 2:** Flash rates and frequencies assume a ± 5% capacitor tolerance. Electrolytics may vary -20% to +100% of their stated value.

**Note 3:** Unless noted, measurements above are made with a 1.4V supply, a 25°C ambient temperature, and an LED with a forward drop of 1.5V to 1.7V a 1 mA forward current.

**Note 4:** Occasionally a flasher circuit will fail to oscillate due to an LED defect that may be missed because it only reduces light output 10% or so. Such LEDs can be identified by a large increase in conduction between 0.9V and 1.2V.

Typical Applications (Continued) (See applications notes on previous page)

3V Flasher

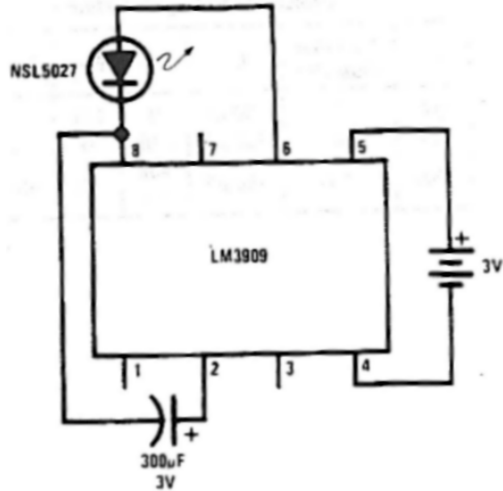

**Note:** Nominal flash rate: 1 Hz. Average IDRAIN = 0.77 mA.

Minimum Power at 1.5V

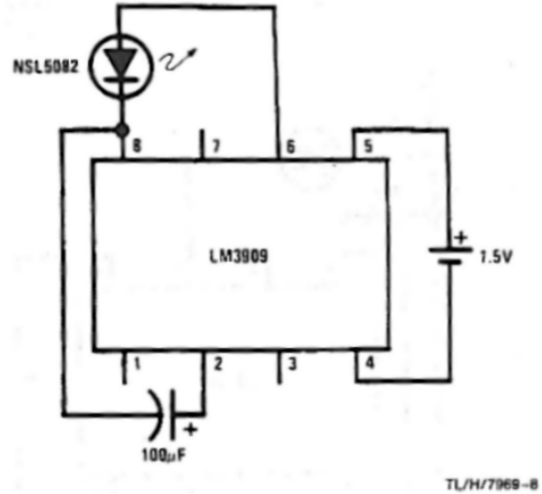

**Note:** Nominal flash rate: 1.1 Hz. Average IDRAIN = 0.32 mA.

Fast Blinker

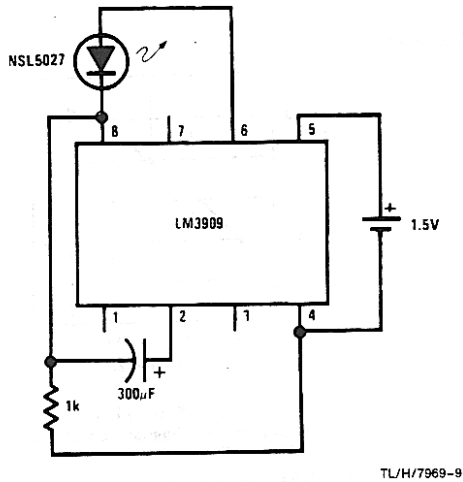

**Note:** Nominal flash rate: 2.6 Hz. Average IDRAIN = 1.2 mA.

**Note:** Nominal flash rate: 2.6 Hz. Average IDRAIN = 1.2 mA.

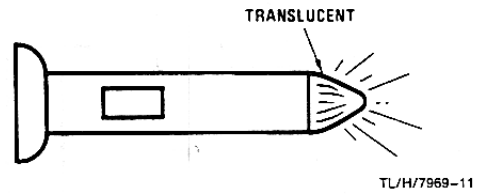

**Note:** Winking LED inside, locates light in total darkness.

Jameco Part number 24192

Typical Applications (Continued) (See applications notes above)

Flashlight Finder

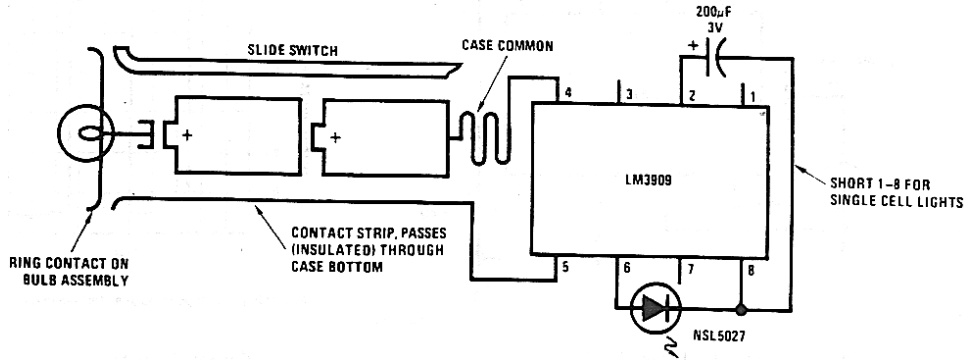

**Note:** LM3909, capacitor, and LED are installed in a white translucent cap on the flashlight's back end. Only one contact strip (in addition to the case connection) is needed for flasher power. Drawing current through the bulb simplifies wiring and causes negligible loss since bulb resistance cold is typically less than  $2\Omega$ .

4 Parallel LEDs

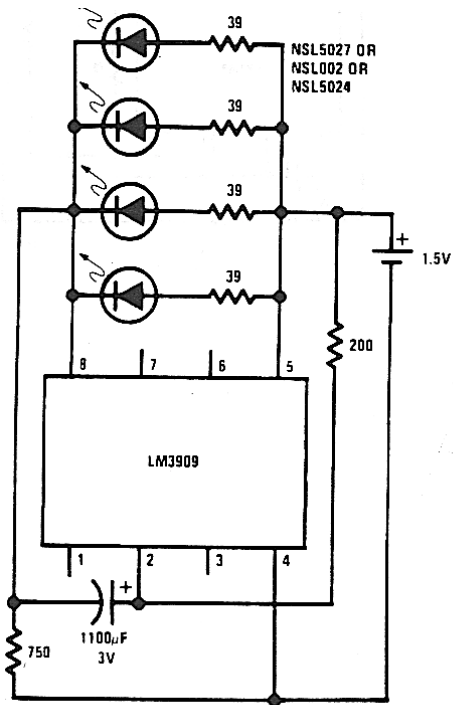

TL/H/7969-12

**Note:** Nominal flash rate: 1.3 Hz. Average IDRAIN = 2 mA.

High Efficiency Parallel Circuit

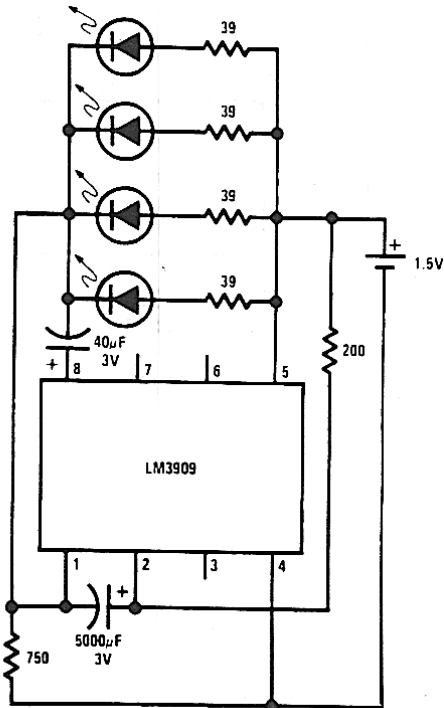

T1 /4/7969-

**Note:** Nominal flash rate: 1.5 Hz. Average IDRAIN = 1.5 mA.

Typical Applications (Continued) (See applications notes above)

LM3909

1 kHz Square Wave

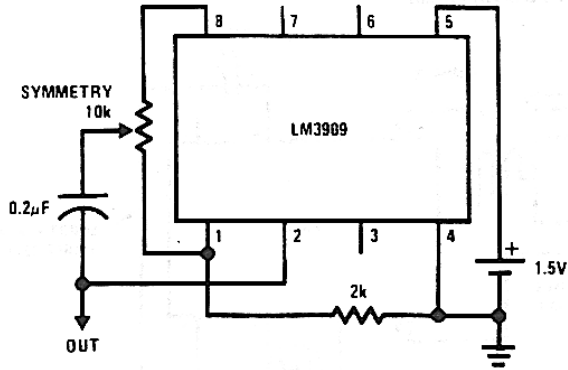

TL/H/7969-14

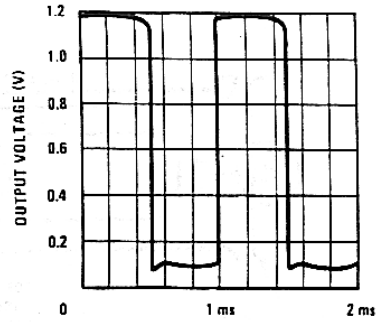

TL/H/7969-15

Note: Output voltage through a 10k load to ground.

"Buzz Box" Continuity and Coil Checker

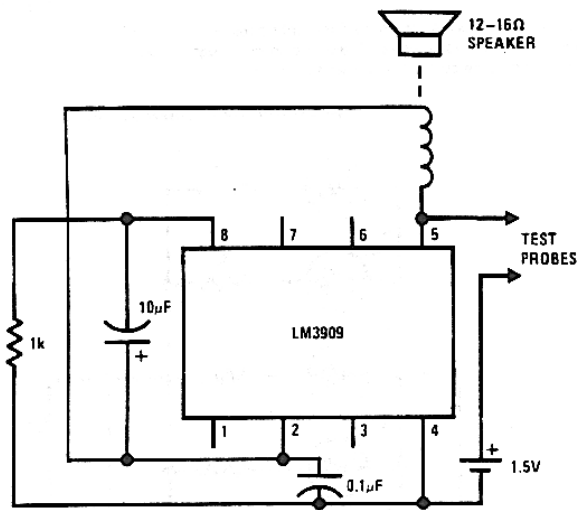

TL/H/7969-16

Variable Flasher

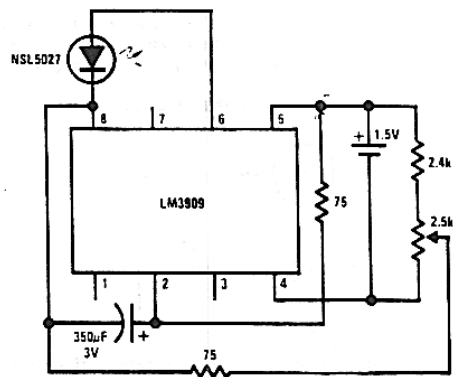

TL/H/7969-17

Note: Flash rate: 0 Hz-20 Hz.

Note: Differences between shorts, coils, and a few ohms of resistance can be heard.

LM3909

**Typical Applications** (Continued) (See applications notes above)

**LED Booster**

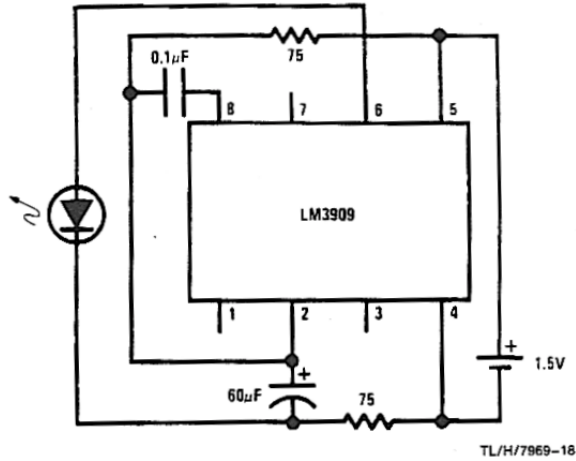

Note: High efficiency, 4 mA drain. Continuous appearing light obtained by supplying short, high current, pulses (2 kHz) to LEDs with higher than battery voltage available.

**Incandescent Bulb Flasher**

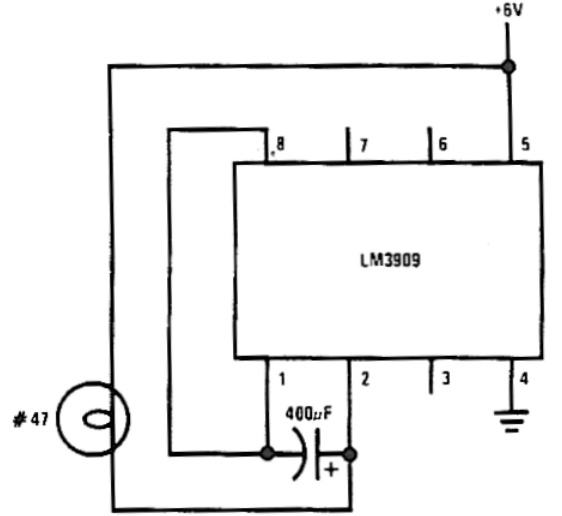

Note: Flash rate: 1.5 Hz.

Note: Flash rate: 1.5 Hz.

**Emergency Lantern/Flasher**

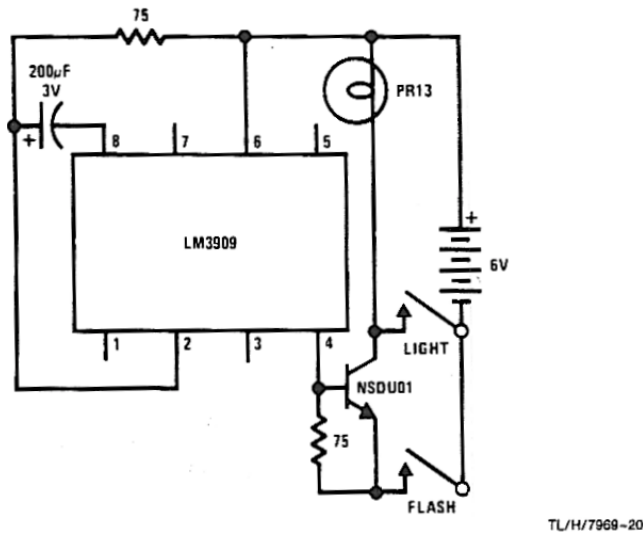

Note: Nominal flash rate: 1.5 Hz.